

Intelligent Maximum Power Point Tracking Using Fuzzy Logic for Solar Photovoltaic Systems Under Non-Uniform Irradiation Conditions

P. Selvam, S. Senthil Kumar

Abstract—Maximum Power Point Tracking (MPPT) has played a vital role to enhance the efficiency of solar photovoltaic (PV) power generation under varying atmospheric temperature and solar irradiation. However, it is hard to track the maximum power point using conventional linear controllers due to the natural inheritance of nonlinear I-V and P-V characteristics of solar PV systems. Fuzzy Logic Controller (FLC) is suitable for nonlinear system control applications and eliminating oscillations, circuit complexities present in the conventional perturb and observation and incremental conductance methods respectively. Hence, in this paper, FLC is proposed for tracking exact MPPT of solar PV power generation system under varying solar irradiation conditions. The effectiveness of the proposed FLC-based MPPT controller is validated through simulation and analysis using MATLAB/Simulink.

Keywords—Fuzzy logic controller, maximum power point tracking, photovoltaic.

I. INTRODUCTION

THE concern for conventional fossil-fuel energy resources are diminishing and world's environmental problem about acid deposition and global warming rises, renewable energy sources are enthralling more concentration as alternative renewable energy sources since it is most abundant, the absence of fuel cost, pollution free, inexhaustible and has been widely utilized in small-scale applications. It is also the most promising area for research and development for large scale utilization as the production of less-costly PV panels becomes an authenticity. However, there are still two main obstacles to the use of PV systems are high installation cost and low energy conversion efficiency that are caused by their nonlinear and temperature dependent I-V and P-V characteristics. The following three significant approaches can be done to overcome these drawbacks, by improving production processes of solar arrays [1], [2], by controlling the insolation input to PV panels which is done through sun-tracking solar collectors [3] and solar cell configurations with respect to change in ambient conditions [4]. By optimizing the electric power output of solar PV panel, it is achieved by tracking maximum power operating point of the solar PV system using suitable control algorithms [5]-[7].

P. Selvam is with the Government College of Engineering Tirunelveli, 627007 Tamilnadu, India (corresponding author, phone: +919894227846, e-mail: selva6477@gmail.com)

S. Senthil Kumar is with Government College of Engineering, Salem, Tamilnadu, India (e-mail: sengce2009@yahoo.in).

Many techniques have been proposed and implemented to provide maximum PV power [8], [9]. Some researchers evaluated the performance of perturb and observation and incremental conductance methods [9]-[11], the former method is easy to implement, but oscillation is present in the output power. The latter method avoids oscillation, but it is more complex for circuit implementation. Altas employed an online MPPT algorithm to obtain maximum power point [12]. Modified incremental conductance algorithm proposed that responds accurately when the solar irradiation level increases [13]. Neural network based the intelligent controller proposed hybrid generation system consists of solar and wind can provide high efficiency with the use of MPPT control [14].

This paper presents a fuzzy logic based MPPT technique, which can track the maximum power point by eliminating oscillations present in the conventional methods without a need of an accurate mathematical model and handling nonlinearity of PV characteristics effectively to enhance the performance of the solar PV system.

II. PV MODULE MODELING

A PV module is the number of PV cells connected in series. The PV cell represented by many equivalent circuits, where the single diode model is simple and accurate enough in several cases [15], it is used in this paper. PV cell equivalent circuit consists of current source in parallel with diode, series, and parallel resistance as shown in Fig. 1

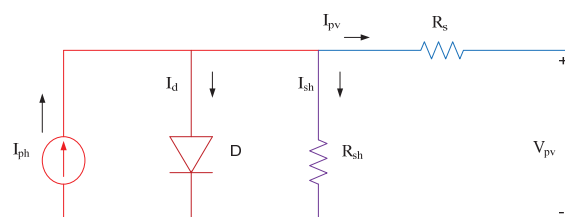

Fig. 1 Equivalent circuit of a PV cell

The notations used in Fig. 1 are defined as follows

- I_{ph} - Photo current
- I_d - Diode current
- I_{sh} - Current through parallel resistance
- I_{pv} - Output current
- V_{pv} -Output voltage
- D - Parallel diode
- R_{sh} -Shunt resistance

• R_s -Series resistance

The solar PV cell is the PN junction diode, whose electrical characteristics differ very little from a normal diode, represented by the equation of Shockley,

$$I_d = I_{rs}(\exp(qV_d / AKT) - 1) \quad (1)$$

q - the charge of an electron, 1.6×10^{-19} (Coulomb); A - the diode ideality constant; K - the Boltzmann's constant 1.38×10^{-23} (J/K); T - the cell temperature (K); I_{rs} - the diode reverse saturation current.

The I-V characteristics equation of a PV cell from the equivalent circuit of Fig. 1 is as

$$I_{pv} = I_{ph} - I_{rs}(\exp(q(V_{pv} + R_s I_{pv}) / AKT) - 1) - (V_{pv} + R_s I_{pv}) / R_{sh} \quad (2)$$

The PV module is the combination of no. of series connected PV cells (N_s), represented by following characteristics equation,

$$I_{pv} = I_{ph} - I_{rs}(\exp(q(V_{pv} + R_s I_{pv}) / N_s AKT) - 1) - (V_{pv} + R_s I_{pv}) / R_{sh} \quad (3)$$

The output voltage and current of the PV module depend on the solar irradiation and temperature [16].

$$I_{pv} = I_{pvr}[1 + \alpha(T - T_r)] (S/S_r) \quad (4)$$

$$V_{pv} = V_{pvr}[1 + \alpha \ln (S/S_r) + \beta(T-T_r)] \quad (5)$$

S_r , T_r are the reference irradiation and temperature of the PV module under (STC) standard test conditions respectively (25 °C and solar irradiance of 1000 W/m², AM1.5 spectrum). I_{pvr} - Output current of PV module under STC; V_{pvr} - Output voltage of PV module under STC; S -Actual irradiation fall on the surface of PV module; T - Actual PV module temperature in °C, it is kept as constant at 25 °C in this work. α - Temperature Coefficient of open circuit voltage (V_{oc}); β - Temperature Coefficient of short circuit current (I_{sc})

A PV module, 250Wp made by EMMVEE PV with 60 series connected monocrystalline cells is chosen for evaluating MPPT in this paper. The manufacturer gives the electrical characteristics data under STC as shown in Table I [18]. Figs. 2 (a) and (b) show that the I-V and P-V characteristics of EMMVEE 250 Wp at constant temperature 25 °C and different irradiation conditions 200 W/m², 400 W/m², 600 W/m², 800 W/m² and 1000 W/m².

TABLE I
 ELECTRICAL CHARACTERISTICS OF EMMVEE 250WP MONOCRYSTALLINE PV MODULE

Specifications	Variable	Value
Maximum power	P_m	250Wp
Voltage at maximum power	V_{pm}	30.06
Current at maximum power	I_{pm}	8.32
Open Circuit Voltage	V_{oc}	36.78
Short Circuit Current	I_{sc}	8.75
Temperature Coefficient of V_{oc}	α	-0.33%/K
Temperature Coefficient of I_{sc}	β	+0.04%/K

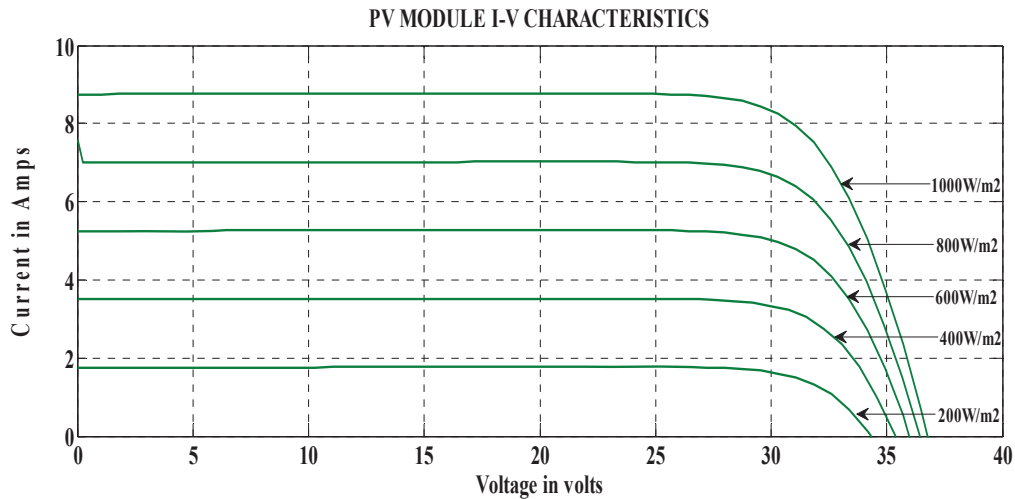

(a)

PV MODULE P-V CHARACTERISTICS

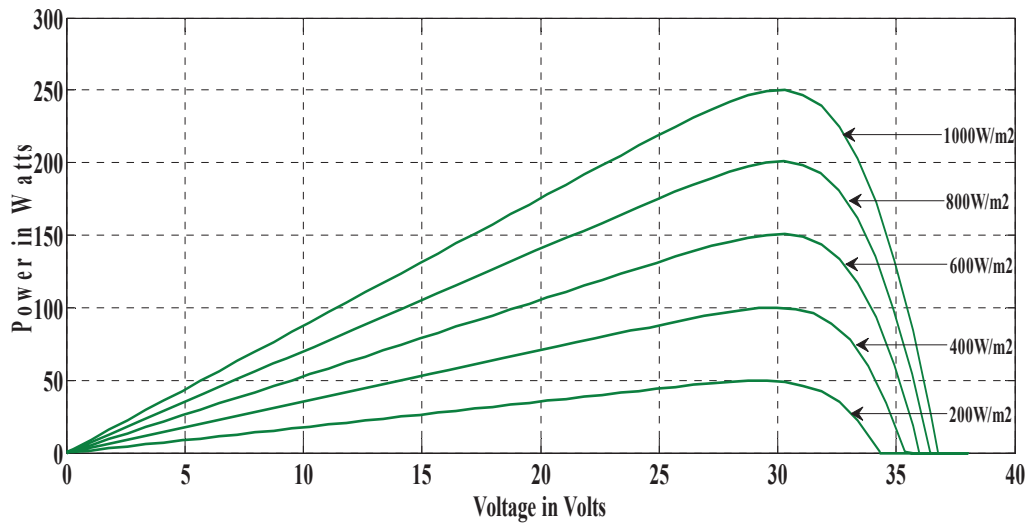

(b)

Fig. 2 PV Module Characteristics for various irradiation levels at a temperature 25°C (a) I-V (b) P-V

III. PROPOSED METHODOLOGY

The proposed system consists of a PV module, dc-dc boost converter, MPPT controller, and resistive load. The PV module transforms solar irradiation into electrical energy in the form of d.c varies according to the variation of irradiation conditions. The PV module output voltage and current are given to the boost converter to match PV module input resistance and load resistance by adjusting the PWM control signal of the power electronics switch to transfer maximum power from PV source to load. Also, PV module output voltage is boosted and regulated to the desired level as per the application. In this paper, the FLC is used to generate the PWM control signal to track the exact maximum power. Fig. 3 shows the block diagram representation of the proposed FLC based MPPT for the solar PV system.

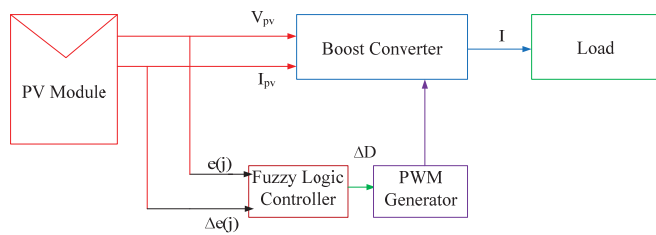

Fig. 3 Block diagram of FLC based MPPT

A. Design of Dc-Dc Boost Converter

DC-DC Boost Converter is used to match the resistance between the input PV module and load resistance for the purpose of achieving MPPT as per the maximum power transfer theorem. Fig. 4 shows a step-up or a PWM boost converter, it consists of dc voltage source as input from solar PV Module V_{pv} , boost inductor L, bidirectional current conduction capable controlled switch S, diode, filter capacitor C, and load resistance R. The switch is controlled with a duty

ratio D defined as a ratio of the switch on time to the sum of the on and off times.

$$D = T_{on} / (T_{on} + T_{off}) \tag{6}$$

where $T = 1/f$ - the period of the switching frequency f.

The average value of the boost converter output voltage [17] is

$$V_o = V_{pv} / (1 - D) \tag{7}$$

The boost converter is designed by proper selection of boost inductor L and filter capacitor C based on the allowable value of ripple current ΔI and ripple voltage ΔV in the output current I_o and voltage V_o respectively.

$$L = V_{pv} D / f \Delta I \tag{8}$$

$$C = I_o D / f \Delta V \tag{9}$$

TABLE II
 DESIGN PARAMETERS OF DC-DC BOOST CONVERTER

Chosen Parameters and values		Designed parameters and values	
Input Voltage	V_{pv} 30.06V	Boost Inductor	L 17.998mH
Output voltage	V_o 60V	Capacitor	C 173.3μF
PV Module Power	P_o 250Wp	Output Current	I_o 4.167A
Switching Frequency	f 20Khz	Load Resistance	R 14.398Ω
Ripple Voltage	ΔV 1%	Duty Ratio	D 0.499
Ripple Current	ΔI 1%		

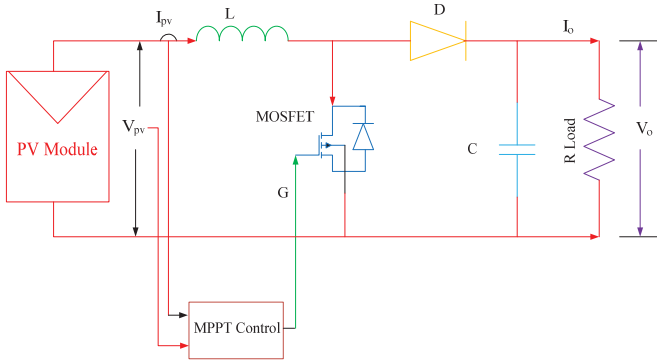

Fig. 4 DC-DC Boost Converter Topology for Proposed MPPT

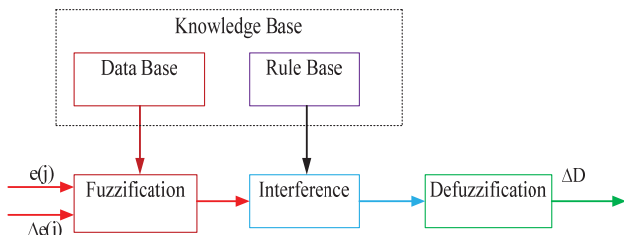

Fig. 5 Block diagram of Fuzzy Inference Systems

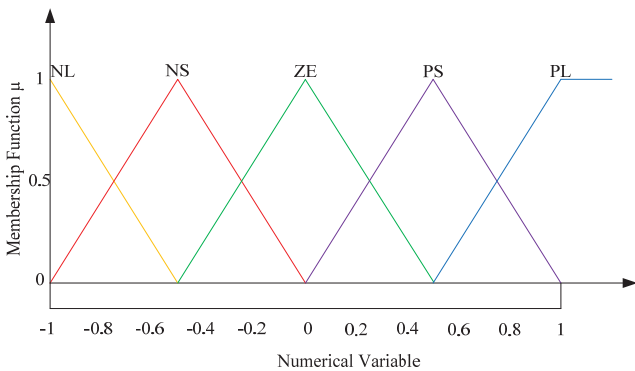

Fig. 6 Membership function for inputs of FLC

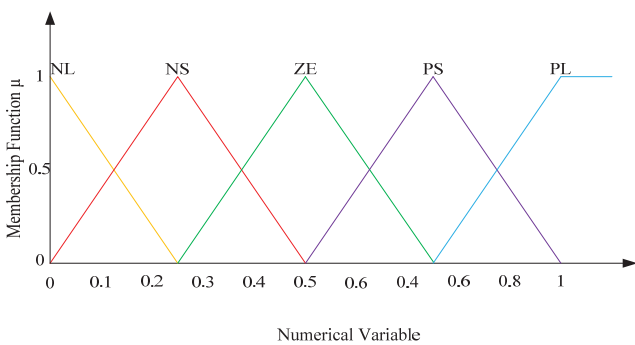

Fig. 7 Membership function for output of FLC

IV. FUZZY LOGIC CONTROLLER (FLC)

The main aim of the control is to extract maximum power from the PV module under various solar irradiation conditions.

In this paper, the FLC is used to extort maximum power and achieve the optimum operating point of the PV module.

Fuzzy logic was introduced by professor of computer science Lotfi A. Zadeh, in the University of California at Berkeley in the year 1965 [19]. Fuzzy logic is a convenient way to map an input space to an output space. It is based on natural language, widely used in systems with complex structure because does not need an accurate mathematical model and well handling of nonlinearity, works better with imprecise inputs. It has fast convergence than a conventional nonlinear controller.

The design of FLC consists of the following three main steps, fuzzification, inference, and defuzzification.

A. Fuzzification

In this process, numerical input variables are translated into linguistic variables based on a membership function using five fuzzy subsets, PL (Positive Large), PS (Positive Small), ZE (Zero), NL (Negative Large), NS (Negative Small). The partition of fuzzy membership function and appropriate range of numerical values are between -1 and 1 as shown in Figs. 6, 7. In this proposed FLC, error (e_j) and change of error (Δe_j) at sample time j , are set as the input parameters. Change in duty ratio, ΔD is chosen as the output parameter, and it is fed to PWM generator to generate the gate signal of power electronic switch in the dc-dc boost converter.

$$e(j) = [P_{pv}(j) - P_{pv}(j-1)] / [V_{pv}(j) - V_{pv}(j-1)] \quad (10)$$

$$\Delta e = e(j) - e(j-1) \quad (11)$$

where, $P_{pv}(j)$ - Power of the PV Module at sample time j ; $V_{pv}(j)$ - Voltage of the PV Module at sample time j .

B. Fuzzy Inference Method

Inference system includes a set of fuzzy rules in linguistic form as well as the database. The database is a collection of expert control knowledge for attaining the fuzzy control objectives. Inference system uses IF-THEN rules along with connectors "OR" or "AND" for making necessary decision rules. Mamdani and Takagi-Sugeno fuzzy systems are the usually used fuzzy inference mechanisms. In this proposed MPPT, the Mamdani's fuzzy inference method is used with the max-min operation to get proper fuzzy inference output. The fuzzy rule base is shown in Table II with e and Δe as inputs and ΔD as output.

TABLE III
FUZZY RULE BASE

ΔD	Change in Error Δe				
	NL	NS	ZE	PS	PL
Error	NL	ZE	ZE	NL	NL
e	NS	ZE	ZE	NS	NS
	ZE	NS	ZE	ZE	PS
	PS	PS	PS	PS	ZE
	PL	PL	PL	ZE	ZE

C. Defuzzification

This process translates the fuzzy quantity into a precise quantity. The output of the fuzzy process may be “union” of two or more fuzzy membership functions of the outputs resulting from each rule. The defuzzification generates a non-fuzzy output control action that best stand for suggested control actions of the different rules. In this MPPT, centroid or centre of gravity method is used for producing defuzzified FLC output ΔD

$$\Delta D = \frac{\sum_j \mu(D_j) D_j}{\sum_j \mu(D_j)} \quad (12)$$

V. RESULTS AND DISCUSSIONS

To assess the performance of the proposed FLC based MPPT, a PV module 250Wp with 60 series connected monocrystalline cells, the dc-dc boost converter and resistive load are modelled in MATLAB/Simulink by keeping PV module temperature as constant. The variable solar irradiance of 800 W/m², and 1000 W/m² and PV current I_{pv} are applied as

an inputs to the PV module (Fig. 8 (b)). The simulation was carried out with the designed values of the dc-dc boost converter. Voltage V_{pv} , power P_{pv} and average voltage V_o , average Power P_o were delivered as outputs from the PV module and dc-dc boost converter respectively.

Fig. 8 shows the response of Power (P_{pv}) and Voltage (V_{pv}) of PV module for the change in irradiance. At $t=0.05$ sec, the irradiance is increased from 800 W/m² to 1000 W/m² as shown in Fig. 8 (a). FLC tracks the voltage at maximum power point (V_{pv}) as indicated in Fig. 8 (d) and this is the input signal to the dc-dc boost converter to track the maximum power. The maximum power extracted from PV module using MPPT exactly coincides with the specifications provided by manufacturer as shown in Table IV. Hence, the true MPPT is reached through the excellent control capabilities of the FLC as shown in Fig. 8 (c). Fig. 9 is validated that the Maximum Power Points of P-V characteristics of the PV module have been achieved through MPPT at different irradiation conditions.

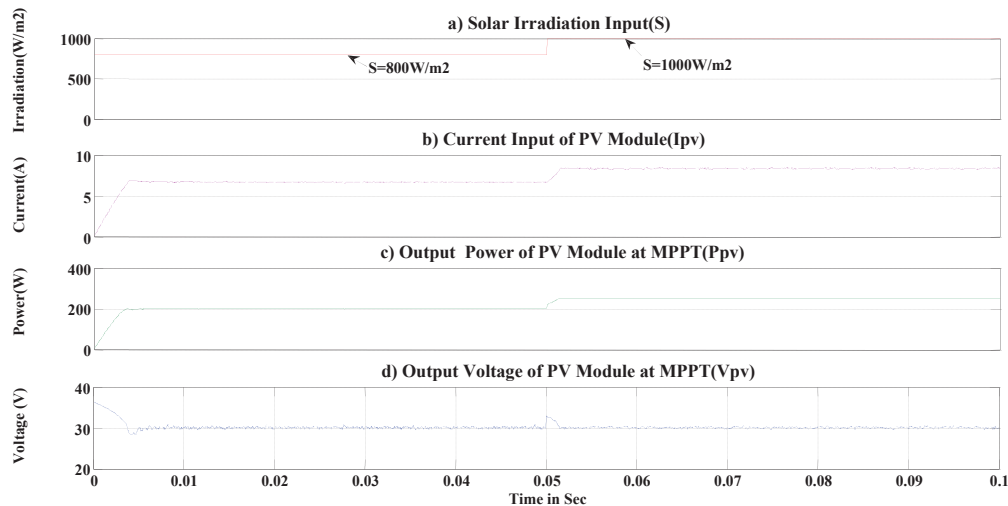

Fig. 8 Response of a PV Module at MPPT

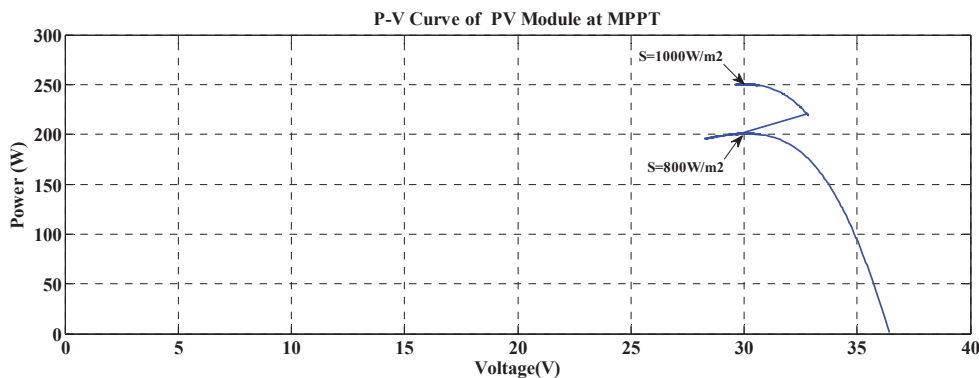

Fig. 9 P-V Characteristics of PV Module at MPPT

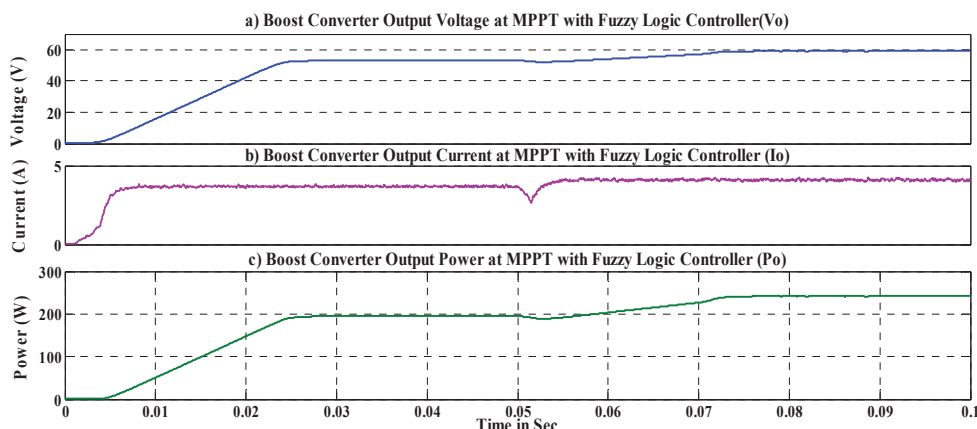

Fig. 10 Boost Converter output at MPPT with FLC

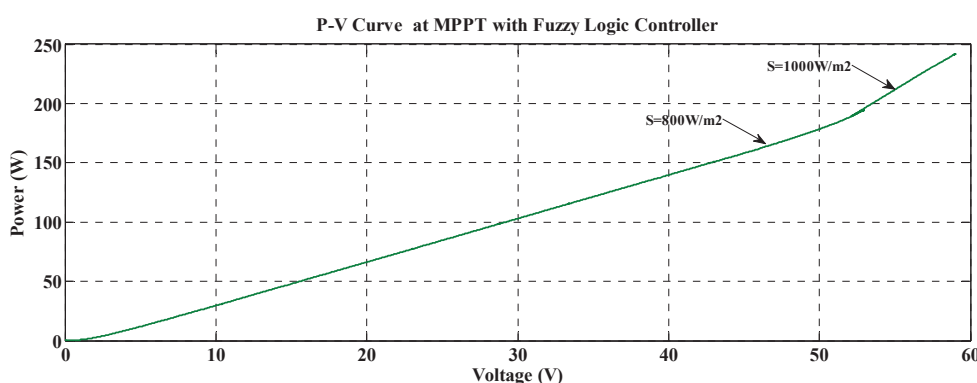

Fig. 11 P-V Characteristics at MPPT with FLC

TABLE IV
 MPPT OUTPUT PARAMETERS

PV Module Specifications		PV Module Output at MPPT			
Maximum Power	P_{pv}	250W	PV Module Power	P_{pv}	250W
Voltage at Max.Power	V_{pv}	30.06V	PV Module Voltage	V_{pv}	30.03V
Current at Max.Power	I_{pv}	8.32A	PV Module Current	I_{pv}	8.327A

The boost converter tracks the maximum power of the PV module and boosts the output voltage into two times as per the design. The simulation results shown in Figs. 10 (a)-(c) are the boost converter output voltage (V_o), current (I_o) and power (P_o). The FLC exhibits an intelligent control capability to maintain the maximum power output smoothly without any oscillations. Fig. 11 presents the P-V characteristics at MPPT, which illustrates the Maximum Power points have been made under different irradiation conditions. The simulation results of proposed FLC based MPPT reveals that the oscillations present in the output power were eliminated.

VI. CONCLUSION

Conventional MPPT methods produce oscillations and complex for circuit implementation. To resolve these problems, an intelligent, fast convergence FLC based MPPT control has been presented. The proposed fuzzy-based MPPT eliminates oscillation, resulting efficiently enhanced MPPT has been achieved. The excellent tracking control capabilities of the proposed MPPT are verified from the simulation results.

REFERENCES

- [1] H. S. Rauschenbach, (1980). Solar Cell Array Design Handbook: The Principles and Technology of Photovoltaic Energy Conversion. New York: Van Nostrand.
- [2] M. A. Green, Solar Cell (1982). Operating Principles, Technology and system Applications. Englewood Cliffs, NJ: Prentice-Hall.
- [3] M. Buresch, (1983) Photovoltaic Energy Systems Design and Installation. New York: McGraw-Hill.
- [4] K. E. Yeager, (1992). "Electric vehicles and solar power: Enhancing the advantages of electricity," IEEE Power Eng. Rev., vol. 12.
- [5] T. Hiyama, S. Kouzuma, and T. Iimakudo, (1995). "Identification of optimal operating point of PV modules using neural network for real time maximum power tracking control," IEEE Trans. Energy Conversion, vol. 10, pp. 360–367.
- [6] T. Hiyama and K. Kitabayashi, (1997). "Neural network based estimation of maximum power generation," IEEE Trans. Energy Conversion, vol. 12, pp. 241–247.
- [7] Salam, Z., Ahmed, J., & Merugu, B. S. (2013). The application of soft computing methods for MPPT of PV system: A technological and status review. Applied Energy, 107, 135–148.
- [8] Tsang, K. M., & Chan, W. L. (2015). Maximum power point tracking for PV systems under partial shading conditions using current sweeping. Energy Conversion and Management, 93, 249–258.
- [9] Ahmed, J., & Salam, Z. (2015). An improved perturb and observe (P&O) maximum power point tracking (MPPT) algorithm for higher efficiency. Applied Energy, 150, 97–108.
- [10] Sivakumar, P., Abdul Kader, A., Kaliavaradhan, Y., & Arutchelvi, M. (2015). Analysis and enhancement of PV efficiency with incremental conductance MPPT technique under non-linear loading conditions. Renewable Energy, 81, 543–550.
- [11] Ishaque, K., Salam, Z., & Lauss, G. (2014). The performance of perturb and observe and incremental conductance maximum power point tracking method under dynamic weather conditions. Applied Energy, 119, 228–236

- [12] I. H. Atlas and A. M. Sharaf, (1996) "A novel on-line MPP search algorithm for PV arrays," IEEE Trans. Energy Conversion, vol.11, pp.748-754.
- [13] Tey, K. S., & Mekhilef, S. (2014). Modified incremental conductance MPPT algorithm to mitigate inaccurate responses under fast-changing solar irradiation level. Solar Energy, 101, 333–342.
- [14] Hong, C.-M., & Chen, C.-H. (2014). Intelligent control of a grid-connected wind-photovoltaic hybrid power systems. International Journal of Electrical Power & Energy Systems, 55, 554–561.
- [15] W. Kim and W. Choi, (2010). "A novel parameter extraction method for the one diode solar cell model," Solar Energy, vol. 84, no. 6, pp. 1008-1019.
- [16] W. Herrmann and W. Wiesner, (1996) "Current-voltage translation procedure for PV generators in German 1000 roofs-programme," presented at the EUROSUN Conf., Freiburg, Germany.
- [17] Muhammad H. Rashid (2001). Power Electronics Handbook Academic Press, page 212-216.
- [18] Emmvee Photovoltaics GmbH, Berlin, Germany, data sheet.
- [19] <http://www.berkeley.edu/news/media/releases/96legacy/zadeh.html>