

# Experimental Study on Flexural Strength of Reinforced Geopolymer Concrete Beams

Khoa Tan Nguyen, Tuan Anh Le, Kihak Lee

**Abstract**—This paper presents the flexural response of Reinforced Geopolymer Concrete (RGPC) beams. A commercial finite element (FE) software ABAQUS has been used to perform a structural behavior of RGPC beams. Using parameters such: stress, strain, Young's modulus, and Poisson's ratio obtained from experimental results, a beam model has been simulated in ABAQUS. The results from experimental tests and ABAQUS simulation were compared. Due to friction forces at the supports and loading rollers; slip occurring, the actual deflection of RGPC beam from experimental test results were slightly different from the results of ABAQUS. And there is good agreement between the crack patterns of fly ash-based geopolymer concrete generated by FE analysis using ABAQUS, and those in experimental data.

**Keywords**—Geopolymer concrete beam, finite element method, stress strain relation, modulus elasticity.

## I. INTRODUCTION

GLOBAL warming is caused by the emission of greenhouse gases into the atmosphere by human activities. And carbon dioxide (CO<sub>2</sub>) is responsible for about 65% of global warming. The global cement industry contributes around 6% of all CO<sub>2</sub> emission because the production of one ton of Portland cement releases approximately one ton CO<sub>2</sub> into the atmosphere [1], [2]. Some researchers have stated that CO<sub>2</sub> emission could increase by 50% compared with the present scope [3], [4]. Therefore, the impact of cement production on the environment issues a significant challenge for concrete industries in the future. As a result, it is necessary to find a new concrete material to replace the traditional Portland cement concrete that is environmentally-friendly, yet maintains an effective construction building material [5]. To this end, geopolymer concrete is a breakthrough development as an essential alternative to the conventional cement, using novel, low-cost and environmentally-friendly materials [6]. Geopolymers are inorganic aluminosilicates produced by alkali activation solutions and source materials. Thus, geopolymer concrete is created by activated industrial waste materials such as fly ash in the presence of sodium hydroxide and sodium silicate solutions. It also has geopolymerization process which is widely different from the hydration process of Portland cement [7].

Almost all researches on geopolymers have determined that this new binder likely has great potential as an alternative to Ordinary Portland Cement (OPC). Geopolymers have received

considerable attention because geopolymer materials may result in environmental benefits such as the reduction in consumption of natural resources and the decrease in the net production of CO<sub>2</sub>. Geopolymer concrete is an innovative binder material and is produced by totally replacing Portland cement. Geopolymer concrete utilizes solid industrial aluminosilicate based waste materials such as fly ash, rice husk ash and silica fume to produce an environmentally-friendly and low-cost material as an alternative to Portland cement.

Up to now, the understanding of structural geopolymer concrete is extremely limited. Some of the research work carried out on comparative study between experimental and analytical work in geopolymer concrete members. Broke et al. [8] reported that the behavior of geopolymer concrete beam-column joints was similar to that of members of Portland cement concrete. Uma [9] performed the flexural response of reinforced geopolymer concrete (RGPC) beams. They compared the results from both ANSYS modeling and experimental data and found that the deflection obtained was found to be low due to meshing of elements in the modeling. They also concluded that comparative result gives 20% difference for experimental and ANSYS 12.0. Also Curtin research on fly ash-based geopolymer concrete is described in research report GC3 [10]. They concluded that the behavior of the geopolymer concrete beam is similar to reinforced Portland cement concrete and a good correlation between test and calculated value is found.

In order to have deeper understanding of the characteristic and behavior of structural geopolymer concrete, this study would evaluate the behavior of geopolymer concrete beams under a four-point bending test by using the experimental test and simulation software (ABAQUS).

## II. MATERIALS AND METHODS

### A. Materials

Low-calcium fly ash known as class F based on ASTM with specific gravity 2500 kg/m<sup>3</sup> is used in this study. This fly ash is dry and from the F power station as shown in Fig. 1. The details of chemical composition of fly ash are presented in Table I.

Aggregates, including 20mm and 10mm coarse aggregates (CA) and fine aggregates (FA) were used. They were mixed with the ratio 4:3:3 by mass. The specific gravity of coarse aggregates is 2700 kg/m<sup>3</sup> and 2650 kg/m<sup>3</sup> for fine aggregates

TABLE I  
CHEMICAL COMPOSITION OF FLY ASH

Oxide (%)	SiO <sub>2</sub>	Al <sub>2</sub> O <sub>3</sub>	Fe <sub>2</sub> O <sub>3</sub>	CaO	K <sub>2</sub> O & Na <sub>2</sub> O	MgO	SO <sub>3</sub>	LOI
	51.7	31.9	3.48	1.21	1.02	0.81	0.25	9.63

Kihak Lee is with the Sejong University, South Korea (Corresponding author: e-mail: kihaklee@sejong.ac.kr@sejong.ac.kr).

Khoa Tan Nguyen is with the Sejong University, South Korea (e-mail: tankhoa1303@sju.ac.kr).

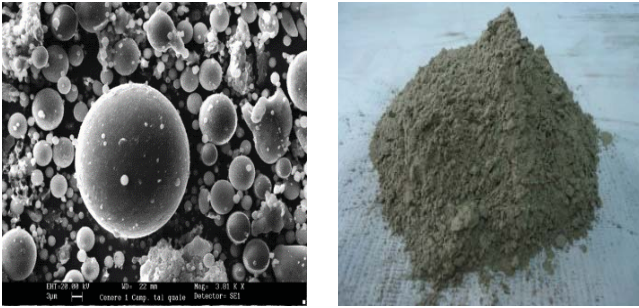

Fig. 1 Fly Ash Type F

### B. Mix Proportion

The details of mix proportions are shown in Table II. For all mix portions, the concentration of sodium hydroxide solution was 8 Molars (M). Water glass and sodium hydroxide are mixed with the ratio 1, 2 and 2.5 by mass. Besides this, the ratio between alkali solutions (including water glass and sodium hydroxide) and fly ash is 0.4, 0.5 and 0.6.

TABLE II  
 MIXTURE PROPORTIONS OF EXPERIMENTAL CONCRETE

Mix	CA (kg/m <sup>3</sup> )	FA (kg/m <sup>3</sup> )	Fly ash (kg/m <sup>3</sup> )	Sodium silicate solution (kg/m <sup>3</sup> )	Sodium hydroxide solution (kg/m <sup>3</sup> )
GPC1	1079	593	418	179	72
GPC2	1113	612	431	154	62
GPC3	1149	632	445	127	51

### C. Mixing

Geopolymer concrete includes: coarse aggregate, fine aggregate, alkaline liquid, fly ash and water.

Coarse aggregates, fine aggregates and fly ash are quantified before mixing. Alkaline liquid is a combination between water glass and sodium hydroxide solution. To make the sodium liquid solution, sodium hydroxide solids would be mixed with water. And then, the sodium hydroxide solution was mixed with the waterglass. The aggregates and fly ash were mixed together firstly about three minutes. Then the alkaline solutions were added to it. Finally, the fresh geopolymer concrete was cast and compacted into molds. The specimens were sent to oven and cured.

### D. Casting

#### 1. Cylinder

A series of nine concrete cylinder of 150 mm in diameter and 300 mm in height were cured in the oven and tested at 7 days' age to determine the compressive strength and stress strain values.

#### 2. Beams

The dimension of the geopolymer concrete beam were 100 mm (b) x 200 mm (h) x 2000 mm (L). Geopolymer beams were cast in steel molds. The details of the beam were shown in Fig. 2.

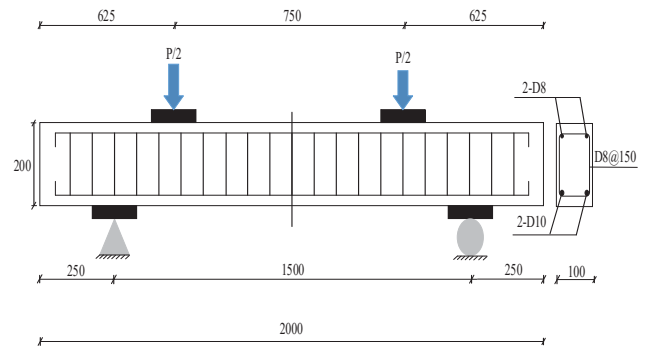

Fig. 2 Details of Geopolymer Concrete Beam

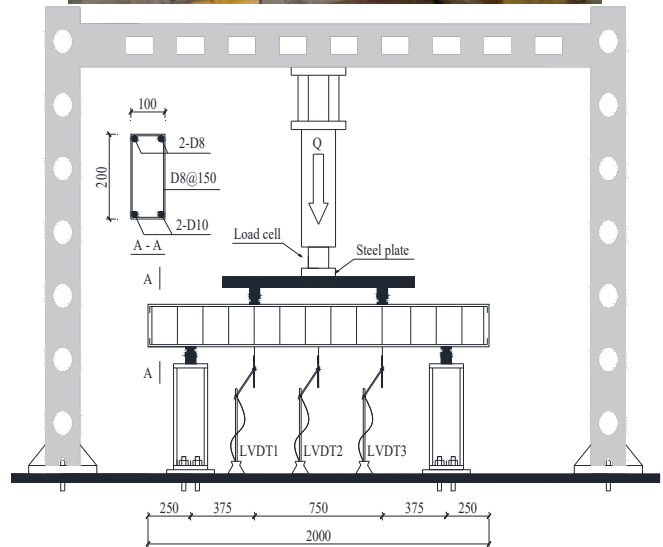

Fig. 3 Schematic of Four-Point Bending Test

### E. Test Methods

#### 1. Cylinder Testing

ASTM C469 [11] is used to obtain modulus of elasticity (Young's) and Poisson's ratio of molded concrete cylinders when under longitudinal compressive stress. And, this test method also provides a stress-strain relation. Three Linear Variable Differential Transducer (LVDTs) were used and fixed at the mid-height of the cylinder. Two LVDTs in the left and right sides were used to measure the lateral deformation and a centrally placed LVDT was used to measure the longitudinal.

Noted that the load must be applied continuously and without shock. The rate of loading is within the range  $241 \pm 34$  kPa/s.

## 2. Beam Testing

In this test, three LVDTs were used to measure the mid-span deflection of geopolymer concrete beam. The prepared fresh geopolymer concrete was poured into molds and compacted as three layers with the same thickness. All beams were cured in the oven under the same curing conditions of the cylinder specimens. In order to reduce the local stress at the supports and load rollers, four steel plates are added to the beam specimen. The size of the plate is 100 mm (b) x 6 mm (h) x 100 mm (L). In this testing, mixture GPC1, GPC2 and GPC3 would be cured at 60°C for 4 hours. The test setup for the four-point bending test is shown in Fig. 3.

## III. FINITE ELEMENT MODEL

In this part, a 3D FE model of geopolymer concrete beams, reinforcement bars, stirrups and steel plates are built employing ABAQUS/CAE [12] structural analysis modeling tool to simulate a four-point bending test. The experimental test is conducted by using the beam model shown in Figs. 2, 3. Figs. 4, 5 show the model of the beam and deflection of the beam in ABAQUS

### A. Concrete

C3D8R element (an 8 node linear brick, reduced integration, hourglass control) was used to model the concrete material. The input data for ABAQUS is shown in Table III.

TABLE III  
 PARAMETERS FOR EXPERIMENTAL CONCRETE USED IN THIS RESEARCH

Mix	$f_c$ (MPa)	$E_c$ (GPa)	$\nu$	$f_{ct}$ (MPa)	$\rho$ (kg/m <sup>3</sup> )
GPC1	30	20.13	0.22	3.46	2400
GPC2	25	18.84	0.22	3.21	2400
GPC3	20	17.41	0.22	2.93	2400

### B. Steel Bar

T3D2 element (a 2-node linear 3-D truss) was used for rebar. The detail of rebar is shown in Table IV.

TABLE IV  
 PROPERTIES OF REINFORCING STEEL BAR USED IN EXPERIMENTAL CONCRETE

Properties	Value
Density	7800 kg/m <sup>3</sup>
Young's modulus	200 GPa
Yielding stress	410 MPa
Poisson's ratio	0.3

## IV. RESULTS AND DISCUSSIONS

### A. Cylinder Results

The stress-strain relation in compression were indicated from the test conducted on cylinder geopolymer concrete specimens. The results are shown in Fig. 6. Also it is observed that the stress-strain relation in compression determined for geopolymer concrete is similar to conventional concrete.

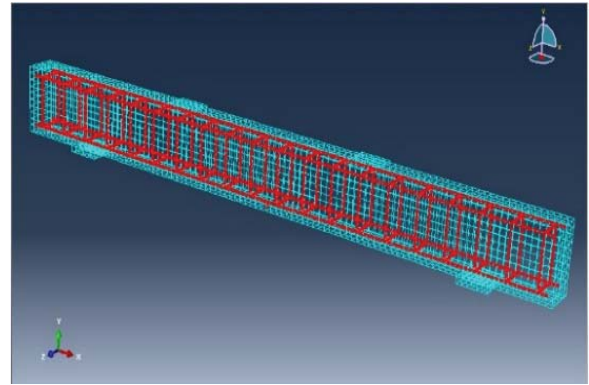

Fig. 4 Reinforcement of Beam in ABAQUS

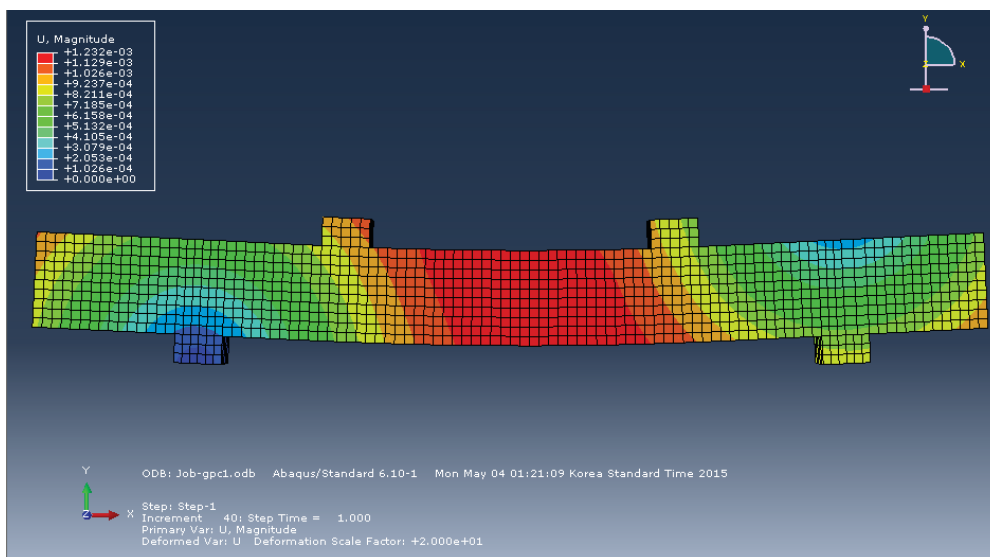

Fig. 5 Deflection of Beam by Using ABAQUS

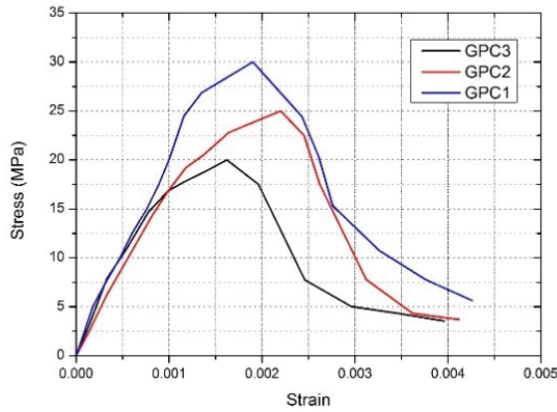

Fig. 6 Uniaxial Compression Test of Concrete

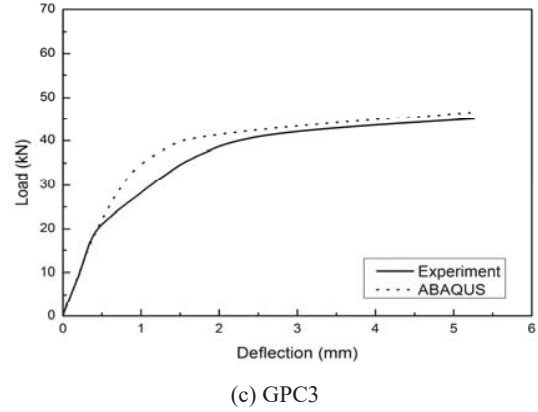
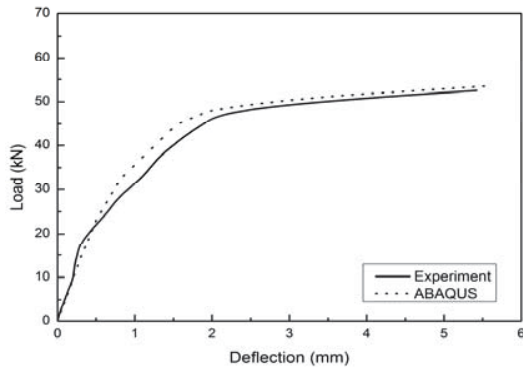

Fig. 7 Load Deflection Curve of the Geopolymer Concrete Beam

**B. Beam Results**

The results shown in Fig. 7 were obtained in two different ways: FE model using ABAQUS and experimental testing. The FE model was used to simulate the experimental beam shown in Fig. 2. From Figs. 7 (a)–(c), it can be seen that the load-deflection curve of the FEM and that from the experimental test are very similar, especially a near match for GPC1. For GPC2 and GPC3, up to the first 2 mm deflection, the FEM models are much stiffer than the experimental model. However, from a 2 mm deflection, the deflection difference of the FEM models and experimental model is gradually reduced and convergent before the model is failed.

The data in Fig. 7 shows fair agreement between ABAQUS and experimental test results. The reason is that the FE model was intended to be an exact replicate of the actual beam, but there are still differences. When the actual beam works during the four-point bending test, friction forces appear at the supports and loading rollers. However, it is difficult to determine this kind of force under real conditions. Thus, the friction forces are simulated by ABAQUS approximately with real conditions. In ABAQUS, the property “Tie” is given when the relationship between the beam model, and the supports. The “Surface to Surface contact” is given when the relationship between the beam model, and the loading rollers. Moreover, the re-bars are given the property “Embedded” (in Constraints) and the simulation includes composite action between concrete and steel. However, in the actual beam, slip occurs, so this assumption would not be true. These factors affect the final result, and are the main reasons for inconsistency in the simulated and experimental results.



(a) GPC1

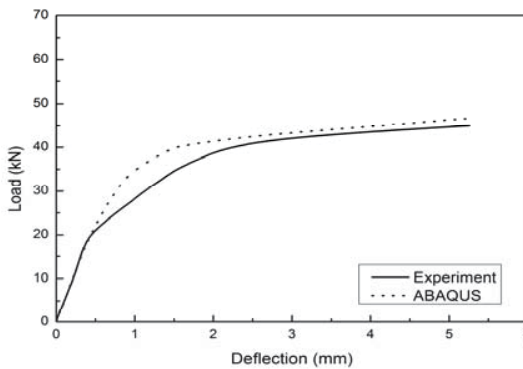

(b) GPC2

For each applied load step, a crack pattern was created using the ABAQUS program. A comparison of the concrete patterns from the numerical results, with those obtained by experimental testing, is shown in Fig. 8.

In general, flexural cracks occur early at mid-span. When the loads increase, vertical flexural cracks spread horizontally from the mid-span to the support. At higher loads, diagonal cracks appear. Increasing the load even more produces additional diagonal and flexural cracks. There is good agreement between the crack patterns of fly ash-based geopolymer concrete generated by FE analysis using ABAQUS, and those in the experimental data.

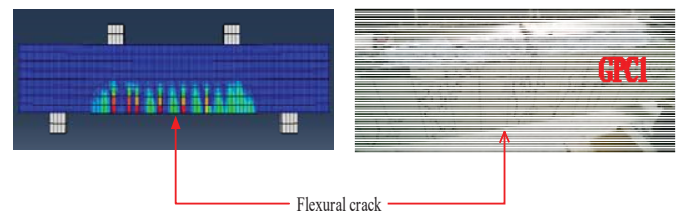

(a) Crack Patterns of mixture GPC1

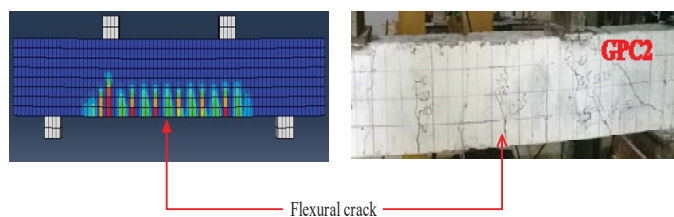

(b) Crack Patterns of mixture GPC2

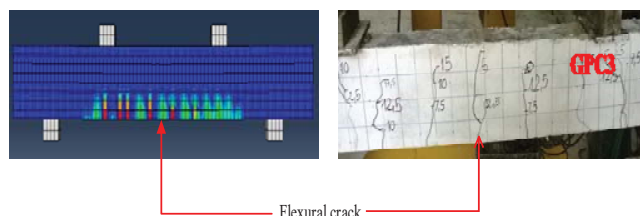

(c) Crack Patterns of mixture GPC3

Fig. 8 Crack Patterns of Experimental Beams

## V. CONCLUSIONS

The behavior of heat-cured, low-calcium fly ash-based geopolymer concrete is in good agreement in the FE simulation using ABAQUS. The measured deflections of the beam and the predicted deflection using ABAQUS agree quite well.

## ACKNOWLEDGMENT

This research was supported by a grant (2011-0010384) from National Research Foundation of Korea (NRF).

## REFERENCES

- [1] McCaffrey R. Climate Change and the Cement Industry. *Global Cement and Lime Magazine*. 2002; 15-9.
- [2] Davidovits J. Global Warming Impact on the Cement and Aggregates Industries. *World Resource Review* 1999; 46: 263-78.
- [3] Davidovits J. Synthesis of new high temperature geopolymers for reinforced plastics/composites. *SPE PACTEC 79*, Society of Plastic Engineers 1979; 151-54.
- [4] Davidovits J. Ancient and modern concretes: what is the real difference. *Concr. Int.* 1987; 12, 23-5.
- [5] Davidovits J. *Geopolymer chemistry and Applications*, 3rd ed. France: Institut Geopolymer; 2011.
- [6] Duxson P. Effect of Alkali cations on Aluminum incorporation in Geopolymeric gels. *Ind. Eng. Chem. Res.* 2005; 44: 4-832.
- [7] Ganesan N, Abraham R, Deepa RS, Sasi D. Stress-strain behavior of confined Geopolymer concrete. *Cons. Build. Mater.* 2014; 73, 236-331.
- [8] Brooke NJ, Keyte LM, South W, Megget LM, Ingham JM. Seismic Performance of 'Green Concrete' Interior Beam-Column Joints. In *Proceeding of Australian Structural Engineering Conference (ASEC) 2005*, Newcastle.
- [9] Uma K, Anuradha R, Venkatasubramani R. Experimental investigation and analytical modeling of reinforced geopolymer concrete beam. *Int. J Civ. Struct. Eng.* 2012;3.
- [10] Sumajouw MDJ, Rangan BV. Low calcium fly ash-based geopolymer concrete: Reinforced beams and columns. Research report GC-3 2006, Faculty of Engineering, Curtin University of Technology, Perth, Australia.
- [11] ASTM C469, Standard Test Method for Static Modulus of Elasticity and Poisson's Ratio of Concrete in Compression.
- [12] Abaqus v. 6. 10. (2010) Dassault Systemes Simulia Corp. Software: Windows 7 OS.