

Estimation of Relative Permeabilities and Capillary Pressures in Shale Using Simulation Method

F. C. Amadi, G. C. Enyi, G. Nasr

Abstract—Relative permeabilities are practical factors that are used to correct the single phase Darcy's law for application to multiphase flow. For effective characterisation of large-scale multiphase flow in hydrocarbon recovery, relative permeability and capillary pressures are used. These parameters are acquired via special core flooding experiments. Special core analysis (SCAL) module of reservoir simulation is applied by engineers for the evaluation of these parameters. But, core flooding experiments in shale core sample are expensive and time consuming before various flow assumptions are achieved for instance Darcy's law. This makes it imperative for the application of coreflooding simulations in which various analysis of relative permeabilities and capillary pressures of multiphase flow can be carried out efficiently and effectively at a relative pace. This paper presents a Sendra software simulation of core flooding to achieve to relative permeabilities and capillary pressures using different correlations. The approach used in this study was three steps. The first step, the basic petrophysical parameters of Marcellus shale sample such as porosity was determined using laboratory techniques. Secondly, core flooding was simulated for particular scenario of injection using different correlations. And thirdly the best fit correlations for the estimation of relative permeability and capillary pressure was obtained. This research approach saves cost and time and very reliable in the computation of relative permeability and capillary pressures at steady or unsteady state, drainage or imbibition processes in oil and gas industry when compared to other methods.

Keywords—Special core analysis (SCAL), relative permeability, capillary pressures, drainage, imbibition.

I. INTRODUCTION

AN imperative petrophysical data required to characterise multiphase flow in petroleum reservoirs is the relative permeability. Several literatures [1]-[5] have been fervent to pointing out the need for relative permeability-saturation relations in reservoir engineering. This information can be obtained through analysis of samples obtained from supposed reservoir.

With modern extraction methods of hydrocarbon from supposed reservoirs especially from the nonconventional hydrocarbon reservoirs, properties such as relative permeability (K_r) and capillary pressure (P_c) features of the rock and fluid must be known [6]. These features are intricate petrophysical parameters for the evaluation and prediction the hydrocarbon recovery of a field.

F.C. Amadi, G. C. Enyi and G.G. Nasr are with the Spray Research Group (SRG) Petroleum Technology Research Group (PTRG) School of Computing, Science and Engineering University of Salford, Manchester. United Kingdom, M5 4WT (Phone: 07403074764; e-mail: f.c.amadi@edu.salford.ac.uk, G.C.enyi@salford.ac.uk, G.G.nassr@salford.ac.uk).

Due to the complex heterogeneity surrounding shale petrophysical properties, relative permeability to oil, water, and gas and capillary pressure determinations in shale formations are critical parameters and are perhaps the least understood and least accurately known property.

Relative permeabilities are usually obtained from flow experiments on core samples in laboratory using steady state and unsteady state experiments [7], [8].

There are several ways to obtain relative permeability data, but they can generally be classified into two types namely, unsteady-state methods and steady-state methods. The steady state experiment, though reliable, can achieve a complete data of K_r after a prolonged experimental time whereas the unsteady state is quicker but is limited to displacements where the assumptions based on Buckley-Leverett theory is fulfilled by ignoring capillary pressure. The other limitation of unsteady state technique is that it does not generate relative permeabilities for the total saturation level. Thus, the unsteady state method is then updated with different analytical techniques which add capillary pressure and determine relative permeability for the entire level of fluid saturation [9]. The centrifuge technique can also be applied in the determination of K_r but not for the entire saturation range [10]. In carrying out the experiments, the operating conditions utilized are within close proximity of the supposed field/reservoir in order to mimic that of the field/reservoir. These conditions generally concern the thermodynamic conditions (temperature, pressure), the reservoir stress (overburden pressure) the nature of the fluids (brine, crude oil), the saturations of the fluids and the wettability [11].

The simultaneous estimation of K_r and P_c with the application of pressure drop and the cumulative production was carried out by Richmond and Watson in 1990 [12].

Chardaire-Rivere, Chavent et al. [8] determined simultaneously K_r and P_c using saturation profiles while incorporating pressure drop and cumulative production data.

The two-phase flow experiment is simulated using a scheme with slopes limiters and implicit discretization for capillary diffusion and optimal control theory to solve the minimization theory.

In the laboratory different techniques are used in acquiring capillary pressure but adjustment methods have also been used to simultaneously estimate K_r and P_c from coreflooding tests [13].

In this paper a 1-D black oil simulator (Sendra) is used in the estimation of K_r and P_c of Marcellus shale in the laboratory.

II. EXPERIMENT

For experimental description, a core sample from Marcellus shale was used. To determine the porosity of the Marcellus shale, two laboratory techniques were applied.

- 1.) The use of a porosimeter (gas PORG-200)
- 2.) Nano Ct scan and porosity calculation

A. Porg-200

In this experiment, a core plug of the Marcellus shale is placed in the matrix cup. Helium is isothermally expanded

into the matrix cup from the reference cell. The initial pressure of the helium gas of the reference cell is logged. The reference cell volume is known and also recorded. The resultant equilibrium pressure is then measured. Both pressures are measured with the digital transducer and visually displayed. The original volume of the matrix cup cell is known. The only unknown parameter is the grain volume and this is resolved using Boyle's law. Fig. 1 shows a sketch of the Boyles Law porosimeter.

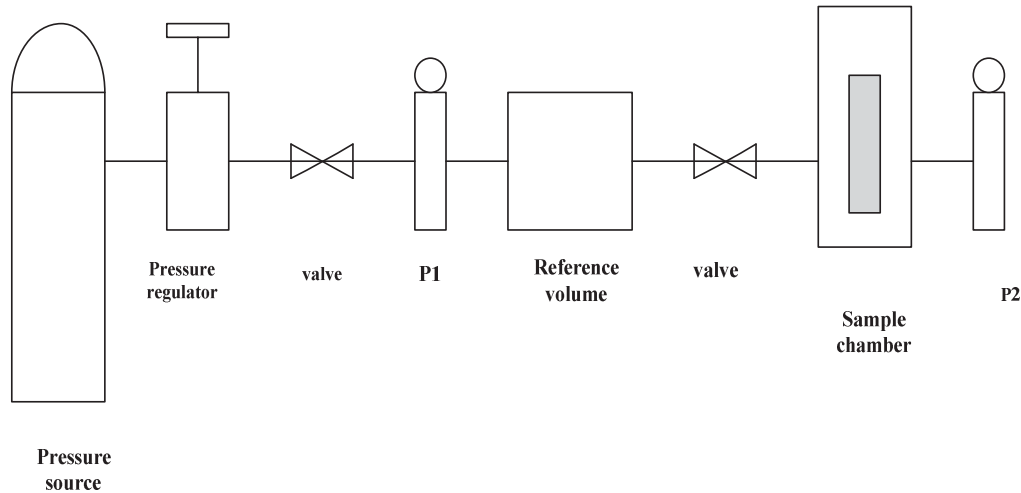

Fig. 1 Schematics of a Boyle's law porosimeter

B. Principle of Operation

The Marcellus shale is placed in the sample chamber at gauge zero and the reference cell is filled with Helium gas at pressure P_1 , then the valve between the two chambers is open and the system is brought to equilibrium. The numbers of moles in both chambers are considered to be the same:

$$n_1 = n_2 \quad (1)$$

Applying Boyle's law:

$$P_1 V_{Ref} = P_2 V_{Ref} + V_{Sam} - V_S \quad (2)$$

Thus

$$V_S = \frac{P_2 V_{Ref} + P_2 V_{Sam} - P_1 V_{Ref}}{P_2} \quad (3)$$

where V_S is the volume of solids in the rock, V_{Ref} is the volume of the reference chamber, V_{Sam} is the volume of the sample chamber, P_1 is the pressure before opening the valve, and P_2 is the pressure at equilibrium after opening the valve. The principle described gives the solid volume of the sample with the gas filling only the effective volume of the rock. The bulk volume of the Marcellus shale sample was measured directly using a calliper.

C. Nano CT

Micro and Nano-CT scanners produce 2D representations of a slice of an object based on material density, measured by X-ray transmissions. The resulting slice is made up of 3D pixels, known as 'voxels'. The micro Ct scan carried out is a non-destructive technique that creates digital slices of the core sample using penetration radiation. The shale sample is rotated inside a beam of x-rays and two dimensional radiographs are collected from many directions. The computer is used to line up and center the x-ray images in a radial pattern. The images are then sectioned (sliced) horizontally to produce a stack.

A scan of the Marcellus shale as shown in Fig. 2 (a) was carried out at 0.9microns. 2D reconstructions were performed with visual studio software on a HP Z820 workstation. Segmentation on the image was done to reduce computational time enhance image reconstruction resolution. A section of the sample as shown in Fig. 2 (b) was segmented and used for the image extraction and volume analysis. After segmentation the image is extracted and a 3D visualisation of the extracted geometry as shown in Fig. 2 (c) of the processed CT scans of the Marcellus shale. Porosity of the scanned Marcellus shale was then calculated using the complex computational algorithm in the software package.

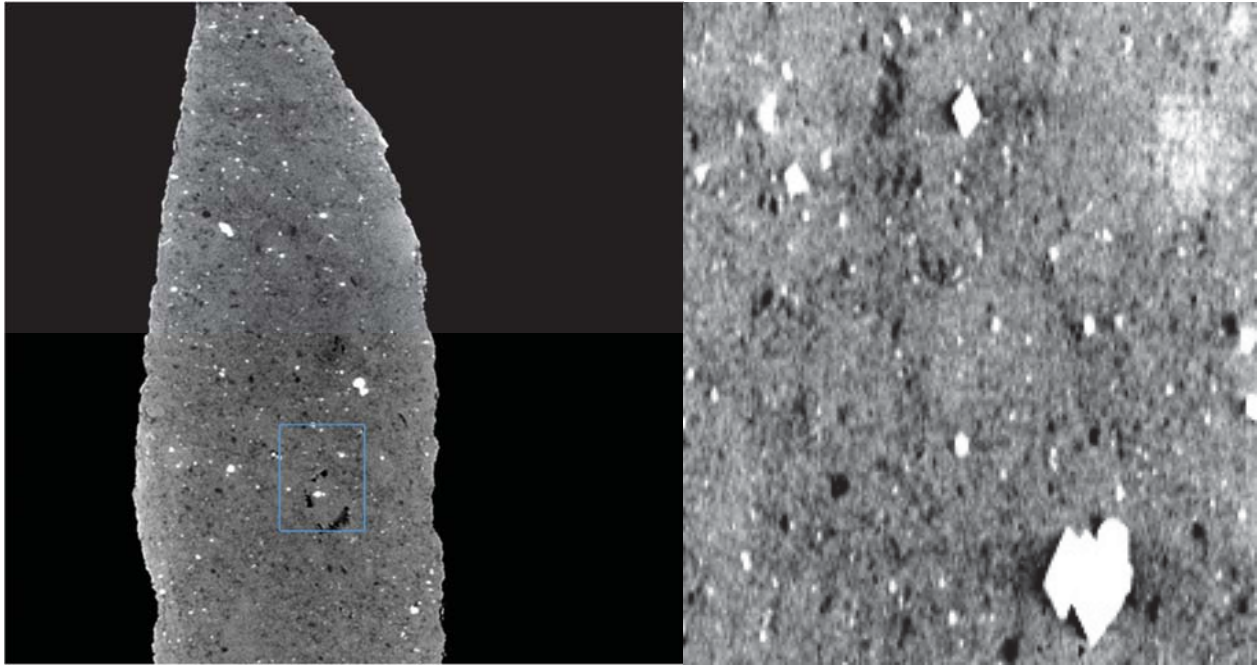

(a)

(b)

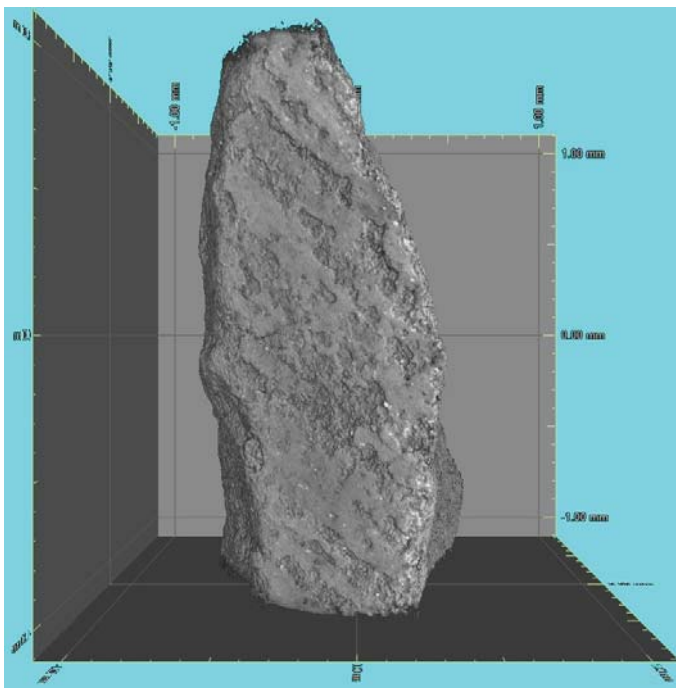

(c)

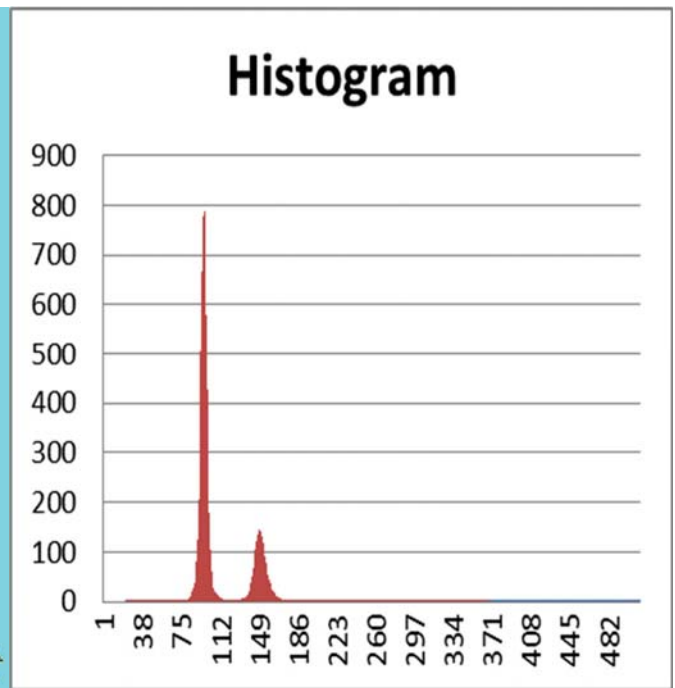

(d)

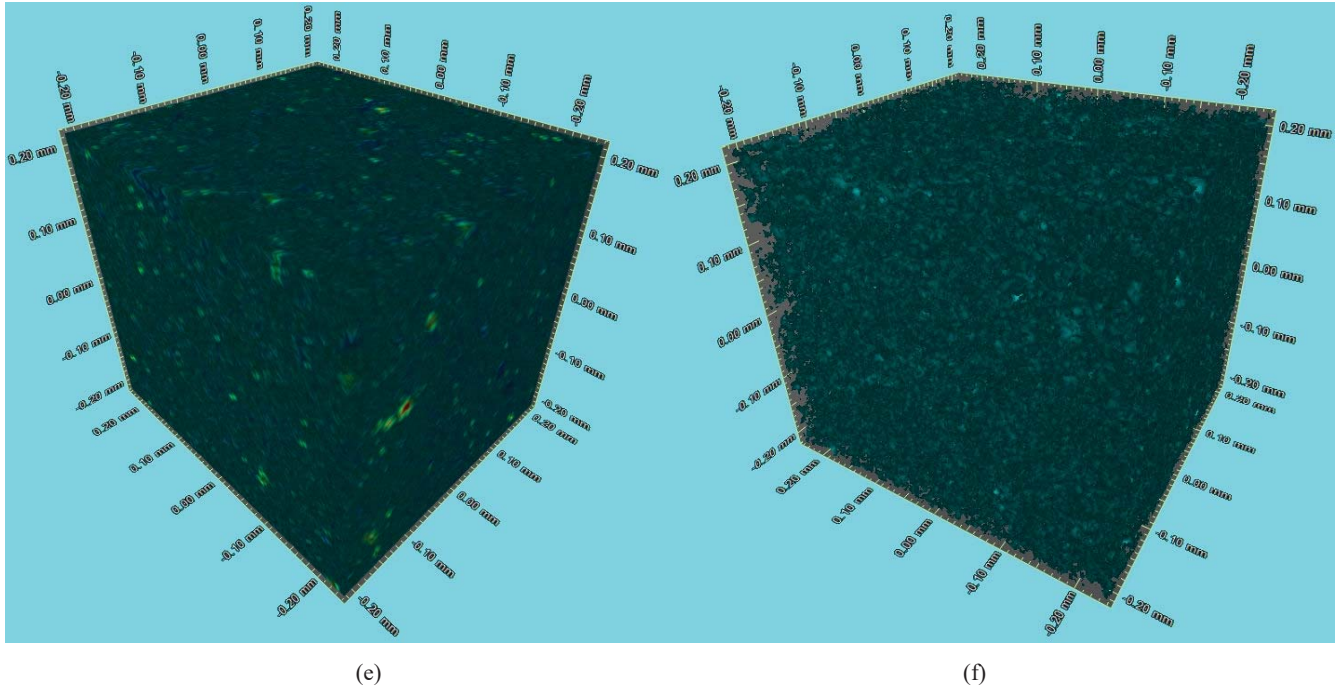

Fig. 2 (a) Scan of the showing and also extracted ROI (b) Extracted ROI (c) 3D image of scanned Marcellus shale (d) Histogram plot generated for reconstruction. (e) 3D visualisation of the extracted ROI geometry of the processed CT scans of the Marcellus shale (f) Visualisation of the pore spaces for porosity calculation

III.SIMULATION OF COREFLOODING

Sendra software was used for simulation. Sendra is a 1-D black oil simulator where different scenarios of core flooding with different phases of reservoir fluids can be performed. Sendra encompasses different experiments: oil-water, oil-gas with drainage and imbibition.

This paper presents imbibitions process of oil water coreflooding scenerio. Unsteady state constant rate flooding was also selected. Required rock and fluid properties for simulation are listed in Table I.

A forward simulation method was used to simulate the K_r and P_c curves with available correlations using Sendra. For K_r , Sendra incorporates the correlations in Table II and for P_c , Sendra incorporates correlations in Table III.

IV.RESULTS

The estimated porosity of Marcellus shale from the Nano Ct and PORG-200 was 5.6% and 4.1% respectively. These two values, gave an estimated average porosity of 4.85%. this average value was then fed into the sendra software.

From the results of the simulation, the K_r and P_c was estimated. Figs. 3 and 4 and Figs. 5 and 6 are graphical plots of K_r and P_c curves respectively using the Corey / Skjaeveland and Sigmund Mccaffery / Benstine Anli correlations. At cross points of the correlations, both correlation combinations gave a similar water saturaion (frac) value of 0.533 while the K_r using the Corey/Skjaeveland is 0.044 and Sigmund Mccaffery/Benstine Anli is 0.047.

TABLE I
 PROPERTIES OF MARCELLUS CORE SAMPLE AND CRUDE OIL USED IN SIMULATION

Diameter (cm)	1.5
Length of sample (cm)	6
Porosity (%)	4.85%
Base Permeability(mD)	2.67×10^{-8}
Oil viscosity (cp)@ 50°C	2.90*
Water viscosity (cp)@ 50°C	0.547

*Oil used is Bonny Light

TABLE II
 5 CORRELATIONS AVAILABLE IN SENDRA FOR ESTIMATING K_r

Relative Permeability (K_r)	
Corey	
LET	
Sigmund McCaffery	
Chierici	
Burdine	

TABLE III
 5 CORRELATIONS AVAILABLE IN SENDRA FOR ESTIMATING P_c

Capillary Pressure(P_c)	
Skjaeveland	
Burdine	
Benstine Anli	
LET-Imbibition	
LET-Drainage	

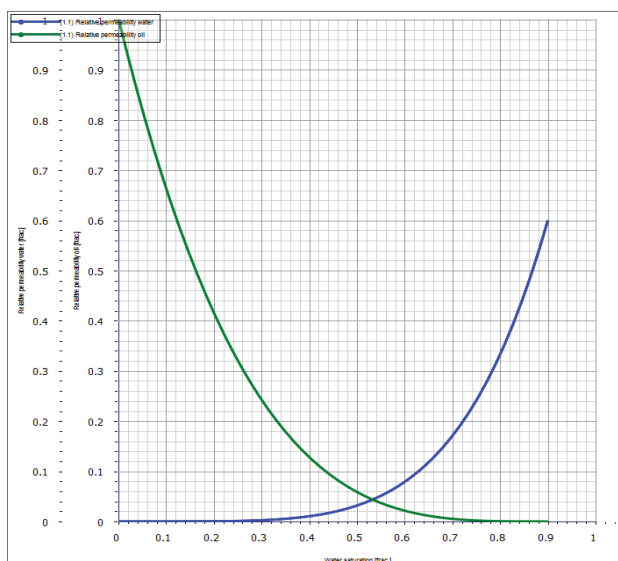

Fig. 3 Relative permeability (K_r) estimation using Corey / Skjaveland correlation

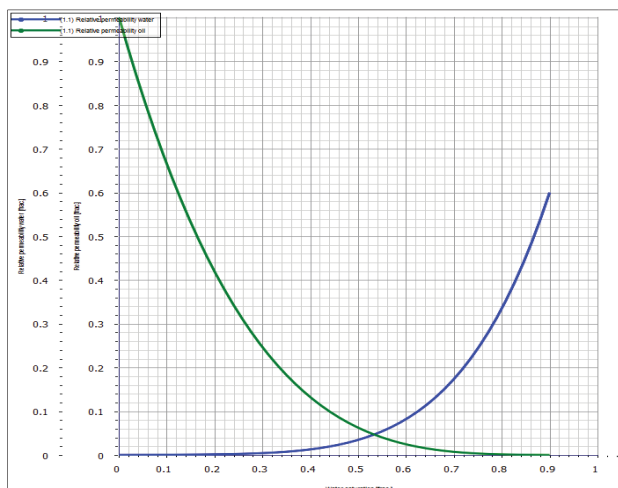

Fig. 4 Relative permeability (K_r) estimation using Sigmund McCaffery / Benstine Anli correlation

V. DISCUSSION

Out of the 20 other correlations, results of Corey/Skjaveland and the Sigmund McCaffery/ Benstine Anli correlation presented in this work exhibits best result comparisons in estimation of K_r .

There are numerous computational algorithms applied in the determination of K_r and P_c with some of them ignores the P_c . Sandra proffers flow experiment at any rate at reservoir conditions. Sandra is less time consuming and determines K_r and P_c for the whole saturation change. Estimation in Sandra can be performed with different pressure and more saturation profiles

This results presents a faster and more convenient process in estimation of K_r and P_c in shale formations as determination of these petrophysical properties in unconventional formation,

surrounded with intricate complexities have made it difficult and time consuming.

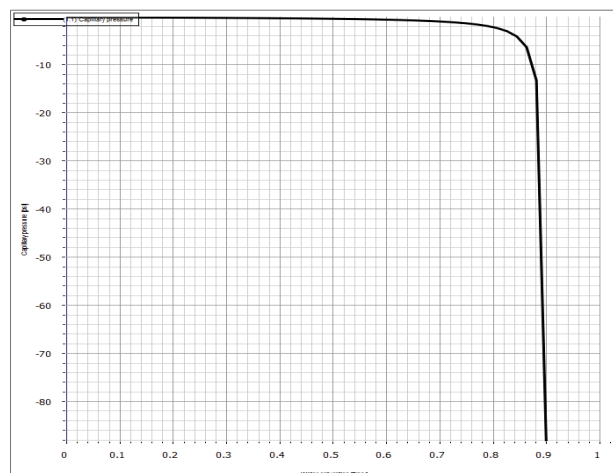

Fig. 5 Capillary Pressure (P_c) estimation using Corey / Skjaveland correlation

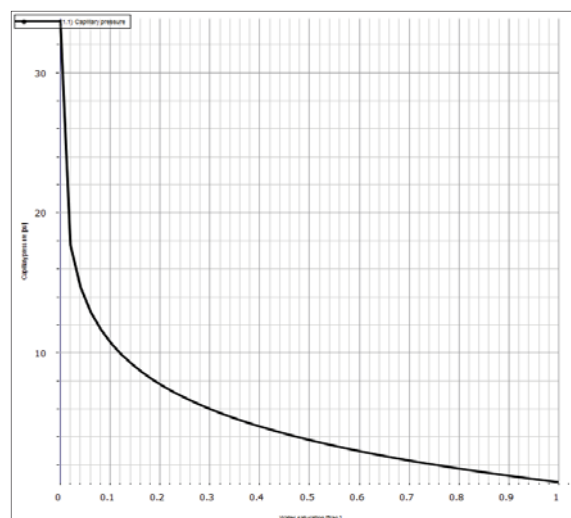

Fig. 6 Capillary Pressure (P_c) estimation using Sigmund McCaffery / Benstine Anli correlation

REFERENCES

- [1] Chierici, G. L. (1984). Novel Relations for Drainage and Imbibition Relative Permeabilities. Society of Petroleum Engineers. doi:10.2118/10165-PA
- [2] Laroche, C., Chen, M., Yortsos, Y. C., & Kamath, J. (2001). Determining Relative Permeability Exponents Near the Residual Saturation. Society of Petroleum Engineers. doi:10.2118/71489-MS
- [3] Eydinov, D., Gao, G., Li, G., & Reynolds, A. C. (2007). Simultaneous Estimation of Relative Permeability and Porosity/Permeability Fields by History Matching Production Data. Petroleum Society of Canada. doi:10.2118/2007-143
- [4] Keilegavlen, E., Nordbotten, J. M., & Stephansen, A. (2011). Simulating Two-Phase Flow in Porous Media with Anisotropic Relative Permeabilities. Society of Petroleum Engineers. doi:10.2118/141552-MS
- [5] Sakurai, K., Watanabe, N., Ishibashi, T., Tsuchiya, N., Ohsaki, Y., Tamagawa, T., & Yagi, M. (2013). Oil-Water Relative Permeability Curves for Fractures in Granite and Limestone at Different Intrinsic Permeabilities. Society of Petrophysicists and Well-Log Analysts

- [6] Kumar, S., Awang, M., Abbas, G., Farouque, K., & Ahmed, S. (2014). Simulation Protocol for Core Flooding: Relative Permeability and Capillary Pressure Analysis. Offshore Technology Conference. doi:10.4043/24715-MS
- [7] Hornapour, M., Koederitz, L., Harvey, A.H. (1986). Relative Permeability of Petroleum Reservoirs. CRC PressInc, Florida Usa
- [8] Chavent, G., Chardaire-Riviere, C., Jaffre, J., & Jun, L. (1990.). Multiscale Representation for Simultaneous Estimation of Relative Permeabilities and Capillary Pressure. Society of Petroleum Engineers. doi:10.2118/20501-MS
- [9] Islam, M. R., Bensten, R.G. (1986). A dynamic method for measuring Relative permeability, J.Cnd.Pet.Tech
- [10] Ruth, D. (1997). The constantly-accelerating centrifuge revisited, Proceedings of the International Symposium of the Society of Core Analysts, The Hague.
- [11] Egermann, P., Lombard, J.-M. N., Fichen, C., Rosenberg, E., Tachet, E., & Lenormand, R. (2005). A New Experimental Method to Determine Interval of Confidence for Capillary Pressure and Relative-Permeability Curves. Society of Petroleum Engineers. doi:10.2118/96896-MS
- [12] Richmond, P.C. and Watson, A.T. (1990). "Estimation of Multiphase Flow Functions from Displacement Experiments," Soc. Pet. Eng. J. 121-127.
- [13] Hashmet, M. R., Tan, I. M., Majidaci, S., & Mushtaq, M. (2012). Simultaneous Determination of Capillary Pressure and Relative Permeabilities. Society of Petroleum Engineers. doi:10.2118/160878-MS.