

Conduction Model Compatible for Multi-Physical Domain Dynamic Investigations: Bond Graph Approach

A. Zanj, F. He

Abstract—In the current paper, a domain independent conduction model compatible for multi-physical system dynamic investigations is suggested. By means of a port-based approach, a classical nonlinear conduction model containing physical states is first represented. A compatible discrete configuration of the thermal domain in line with the elastic domain is then generated through the enhancement of the configuration of the conventional thermal element. The presented simulation results of a sample structure indicate that the suggested conductive model can cover a wide range of dynamic behavior of the thermal domain.

Keywords—Multi-physical domain, conduction model, port-based modeling, dynamic interaction, physical modeling

I. INTRODUCTION

NORMALLY, in multi-physical domain dynamic modeling, the thermal domain dynamics are typically replaced by fixed sources and resistors [1]. As long as the dissipated energy does not return to the system, this way of modeling can help the modeler to simplify the multi-physical system behavior without imposing major negative impacts on the system dynamics. However, in reality, the dissipated energy will come back to the system in the form of thermal energy. This basically means that the thermal source is directly connected to the thermal sink. This returned energy to the system may change the behavior of the system. Thus, the dynamics of the thermal domain are required to be considered as part of the system dynamics.

Depending on the strength of the connectivity of different physical domains with thermal domain, the thermal dynamics can be negligible in some weak connectivity cases under low frequency loading [2]. However, in highly dynamic situations, especially in micro structures, the thermal dynamics play a significant role in forming the total behavior of the system. For example, in a high-frequency thermoelastic phenomenon, there exist simultaneous dynamic interactions between the thermal and mechanical (elastic) domains that can totally change the behavior of the system. The vibration-induced heating can cause unsolicited deformation, and the thermoelastic damping mechanism can result in changes in the dynamics of the system particularly when the system is under

external aero or hydro loading. The unpredicted dynamics of the system would then make the control of the system difficult, e.g., in the case of controlling an aileron that is subjected to external aerothermal loads. This indicates that to adequately investigate multi-physical domain dynamics with strong connectivity with the thermal domain, it is necessary to develop a dynamic thermal model that can couple with the model of the other physical domains.

As the dynamics of the thermal domain, unlike the other domains such as the mechanical domain, are not observable in multi-physical phenomena, a physical model that can vividly reveal the nonlinear interactions between each domain of concern is preferred. Implementing such a model will allow modelers to capture the interactive phenomena (e.g. material softening and viscoelastic damping) through the use of the underlying physics of the system. Also, a physical model is more easily to be connected with other models derived using the same approach. From this point of view, a port-based approach, known as Bond graph (BG) method that works on the basis of power exchange inside a dynamic system [3]-[7], is suggested for this study. This approach is capable of maintaining the integrity of the power flow within a system while extracting the system nonlinear governing equations. The model thus generated is analytical in nature while potentially reflecting the true physical meaning of the system. This is a desirable feature of BG approach over the other existing modelling approaches such as FEM [8]-[10] techniques which are clearly unable to perform in the same context.

Among the existing physical conduction models using port-based approaches, Cellier's [1] and Borutzky's [11] model can be considered as the most complete attempt to investigate the dynamics of the heat transfer inside a rigid body. Although their conventional RC conduction model was capable of capturing the conduction dynamics physically, there was no geometrical consideration of the power transformation between different domains.

Although a physical-modelling approach is a vigorous way to capture the system's physical phenomena, lack of attention to the system geometry can make it unusable for studies of the system dynamic behaviors in multi-physical domain settings. This is because in a multi-physical domain setting, each domain interacts with the other domains simultaneously using the properties that are dynamically varied as a function of the relevant properties of the other adjacent domains. Although different domains can in principle share the same geometry

A. Zanj (PhD candidate) is with the Flinders University, Adelaide, Australia, Department of Science and Engineering, (corresponding author, phone: +61-450-587-253; e-mail: amie.zanj@flinders.edu.au).

F. He. (Associate professor) is with the Flinders University, Adelaide Australia, Department of Science and Engineering, (e-mail: fangpo.he@flinders.edu.au).

setting (thus the transmitted information between different domains can have the same geometrical characteristics), the properties assigned to each of the domains will need to be varied according to the geometrical setting of the other adjacent domains. If this fact is overlooked, then the generated model would be useless in revealing the true physical behavior of the system. Hence, separate energy elements for different domains that are analogous to each other are seen to be necessary to provide the dynamic changes of the properties associated with each of the corresponding physical domains. The geometrical compatibility between different physical domains' elements is thus the key to the success of the investigation of multi-physical phenomena using a physical approach. However, so far no attempt in the literature has been seen to have addressed this problem associated with multi-physical domain studies.

This paper attempts to bridge the gap between a theoretically generated continuous thermal model and its practical realization in a multi-physical domain setting using a discrete geometry that can reflect the geometrical compatibility considerations. This attempt will relate the port-based energy elements to the so-called finite-element approach to form a port-based finite element method. Applying the suggested compatible elements to different domains, a multi-physical domain system can then be effectively modelled by separate power distribution frames with physical interconnections between them. The interactions of these power frames will shape the behavior of the system.

A nonlinear 1D conduction model suitable for multi-physical dynamic investigations is therefore proposed in this paper. A domain-independent conductive discrete element with its thermal characteristics analogous to those of the mechanical elements is introduced using the concept of the port-based approach. The compatibility consideration of the suggested model will provide a guidance for the formation of the complex couplings between the thermal and elastic domains with less mathematical cost. The distinctive domain-independency feature of the conduction model will make it suitable for a wide range of multi-physical domain dynamic investigations, including studies involving aero-servo-thermoelasticity.

The remainder of this paper is organized as follows. In Section II, after a brief explanation of the adjugate physical thermal variables, the calculation of the conventional thermal energy element is discussed. In Section III, a BG representation of the conventional independent conduction model is derived, and its associated governing equations are extracted through the implementation of the port-based approach. In Section IV, the suggested compatible thermal element is presented, and the compatibility of the suggested configuration to form a port-based finite element thermoelastic model is discussed together with the demonstration of the required connections between a standard elastic element and a thermal element. In Section V, by implementing the suggested thermal element, the thermal behavior for a 1D conductive beam is simulated for different boundary conditions and the obtained results are discussed.

Finally, the capability of the suggested domain-independent configured thermal element in modelling the dynamics of heat conduction within an elastic body is concluded in Section VI.

II. DOMAIN INDEPENDENT STATE VARIABLES OF THERMAL DOMAIN

In a physical modeling strategy, the states of the system are chosen on the basis of physical system theory. Accordingly, only the extensive parameters of the system; e.g. entropy in the thermal domain, can be transferred between different elements of the thermal or other domains, resulting in changes in their associated potentials (such as temperature). From this point of view, the potentials of the system can be obtained from the constitutive equations dependent of the extensive parameters. Implementing a physically-meaningful information transfer between different domains will result in a domain-independent modeling strategy. This strategy makes the thermal model connectable to the models of other domains effortlessly. The adjugate physical thermal variables that can form a domain-independent conduction model are explained as follows, based on the physical system theory.

According to the literature, in a well-insulated media, the 1D heat propagation within the system can be described as:

$$\frac{\partial T}{\partial t} = \sigma \frac{\partial^2 T}{\partial x^2} \quad (1)$$

where discretization in space leads to:

$$\frac{\partial^2 T}{\partial x^2} \approx \frac{T(t, x_{i+1}) - 2T(t, x_i) + T(t, x_{i-1}))}{\Delta x^2} \quad (2)$$

$$\frac{dT(t)}{dt} = \frac{\sigma}{\Delta x^2} [T(t, x_{i+1}) - 2T(t, x_i) + T(t, x_{i-1})] \quad (3)$$

$$(i \in 1, \dots, n)$$

where $T(t, x_i)$ denotes the i th element's temperature at time t and location x_i , and σ is the diffusion time.

Conventionally, to calculate the nodal temperature of the system, heat \dot{Q} is used as energy flow between different discrete thermal elements. Employing heat as the flow of the system will lead to the domain dependency of the model. According to the physical system theory, to avoid the domain dependency of the model, the flow of a domain is required to be the rate of the extensive state of the domain, and its correspondent effort (potential) is the constitutive equation of the domain dependent to the state variable. Consequently, the power of a domain can be represented as a product of the flow and the effort of the domain. Given this requirement, heat can't be considered as the flow of the thermal domain as it is, in principle, the power of the thermal domain including the potential.

It is known from thermodynamic science that, for the thermal domain, entropy, s , is the justifiable extensive variable and the temperature, T , is the resultant dependent variable.

Therefore, according to the physical system theory, the rate of entropy must be chosen as the thermal flow and the temperature must play the role of the intensive variable of the thermal domain. The product of these two adjugate thermal variables, T and \dot{s} , form the thermal power inside the system. In a reversible process, the entropy rate can then be obtained as:

$$\dot{s} = \frac{\dot{Q}}{T} \quad (4)$$

It is clear that by implementing the entropy flow instead of the heat flow, the potential component of the conventional heat flow is removed. This gives the thermal model the ability to receive thermal flow from different domains with different constitutive equations. The resultant thermal model will then be domain independent.

III. BG MODEL OF THERMAL CONDUCTION

Applying the domain independent conjugate thermal variable explained in Section II, a physical conduction model can be developed based on a port-based approach. The BG method is chosen as it is a powerful tool to adequately model complex systems with interactions of multiple energy domains [15]. In this method, a unique language is defined to represent quantities in different physical domains. By means of the energy conservation law, the BG method effectively describes the system dynamic behaviors in the form of energy dissipation, storage, and power flow.

Using the BG presentation, a 1D conventional conduction model is described by a chain of dissipative, R , and capacitive, C , energy elements, as shown in Fig. 1. In this model, it is assumed that the thermal energy can be stored in C elements and dissipated while passing through R elements. The model is then expressed by a series of resistive-capacitive energy elements placed interlaced. This BG is exceedingly beautiful; however, it is most certainly incorrect because there are no energy sinks. As can be seen, the amount of energy dissipated by R elements is going nowhere. A resistor may make sense in an electrical circuit, if the heating of the circuit is not of interest, but it is most certainly not meaningful, when the system is itself in the thermal domain.

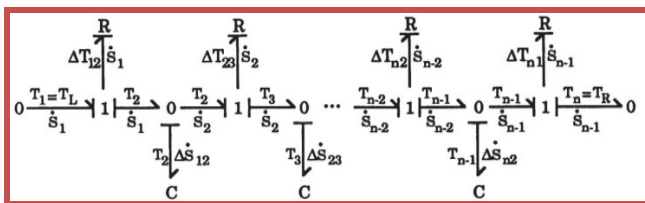

Fig. 1 Conventional BG heat conduction model [3]

It is mentioned earlier that the thermal sink is directly connected to the thermal source in thermal domain. The resistors convert free energy irreversibly into heat as so, the problem may be easily corrected by replacing each resistor by a resistive source shown in Fig. 2, the RS -element. The

entropy generated by RS -element then can re-enter to the thermal domain. The causality of the thermal side is always such that the resistor is seen as a source of entropy, never as a source of temperature why the sources of temperature are non-physical.

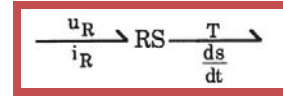

Fig. 2 BG RS element

The obtained BG model implementing RS instead of R is shown in Fig. 3. The temperature gradient leads to additional entropy, which is re-introduced at the nearest 0-junction which provides a good approximation of the physical reality. Unfortunately, the resulting BG is asymmetrical, whereas the conduction equation is symmetrical. It means that this BG model is correct just for one way of heat conduction. Fortunately, this can be easily fixed by the help of RS switches.

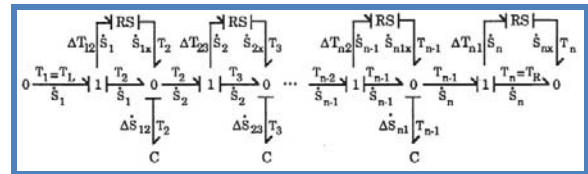

Fig. 3 Modified heat conduction BG [1]

On the basis of the obtained thermal BG integrative causality, the state equation of the thermal domain can be derived from the C storage of each element with respect to the state variable (thermal extensive state) of the i th energy storage element defined as, q_{thi} , which denotes the amount of stored entropy, s , of the i th capacitor. Considering the layout of R_j and C_i elements (Fig. 3), one has:

$$\dot{q}_{thi} = \dot{s}_j - \dot{s}_{j+1} + \dot{S}_i^{gen} \quad (5)$$

where the \dot{s}_j , \dot{s}_{j+1} , and \dot{S}_i^{gen} are the amount of reversible inlet, outlet entropy flow and the entropy generation rate respectively. The internal thermal flow can be obtained as:

$$\dot{s}_j = \frac{1}{R_j} (C_{i-1}(q_{thi-1}) - C_i(q_{thi})) \quad (5)$$

where R_j is the resistant coefficient of the j th RS element and $C_i(q_{thi})$ is a capacitive function of the state of the i th storage element representing the temperature (potential) of the segment. Substituting (6) into (5) yields:

$$\dot{q}_{thi} = \frac{1}{R_j} (C_{i-1}(q_{thi-1}) - C_i(q_{thi})) - \frac{1}{R_{j+1}} (C_i(q_{thi}) - C_{i+1}(q_{thi+1})) + \dot{S}_i^{gen} \quad (6)$$

To identify the R and C in BG for the thermal domain, let's assume that the capacity of a long well-insulated rod to conduct heat is proportional to the temperature gradient. Using (4), one has:

$$\Delta T = \theta \dot{Q} = (\theta T) \cdot \dot{s} = R \cdot \dot{s} \quad (7)$$

$$\theta = \frac{l}{\lambda A} \quad (8)$$

where θ , λ , l and A are the thermal resistance, specific thermal conductance coefficient, length and cross-section area of the segment, respectively. Considering Δx as the length of the j th resistive energy element, the related coefficient can be derived as:

$$R_j = \frac{\Delta x_j T_j}{\lambda_j A_j} \quad (9)$$

According to the Fourier heat conduction law, the capacity of a long well-insulated rod to store heat satisfies the capacitive law, thus:

$$\Delta \dot{s} = \frac{\gamma}{T} \frac{dT}{dt} = C \frac{dT}{dt} \quad (10)$$

$$\gamma = Vc \quad (11)$$

where C , ρ and V are the specific heat capacity, density and volume of the segment. Considering l_i as the length of the storage element, the capacity coefficient of the i th energy store can be presented as:

$$C_i = \frac{c_{ii} A_i l_i}{T_i} \quad (12)$$

From (10) and (13) it is clear that the thermal R and C elements, contrary to their electrical and mechanical counterparts, are not constant parameters. This makes the thermal domain highly nonlinear. Also, it can be obtained that the thermal resistance is proportional to the temperature, and the thermal capacity is inverse proportional to the temperature. Hence, the diffusion time constant RC is independent of temperature, as so the generated state equation (7) according to the physical states are consistent with heat conduction differential equation (3).

To calculate the effort of the storage element, T , presented as $C_i(q_{thi})$ in (6), by integration (11), the temperature of the segment dependent to the local state can be obtained as:

$$T_i = C_i(q_{thi}) = T_0 e^{\frac{1}{Vc}(q_{thi} - s_0)} \quad (13)$$

where T_0 and s_0 are respectively the reference temperature and entropy of the i th segment.

The last step to close the generic equations is to calculate the \dot{s}_{gen} . Considering the power transmission in Fig. 2 and the RS connections in the main BG body (Fig. 3), and on the basis of the power continuity, the following relation can be derived for any RS energy element in the model:

$$\dot{S}_i^{gen} T_i = \dot{s}_j (T_{i-1} - T_i) \quad (14)$$

Substituting (6) and (14) into (15) yields:

$$\dot{S}_i^{gen} = \frac{1}{R_j} T_0 e^{\frac{1}{Vc}(q_{thi} - s_0)} \left(e^{\frac{1}{Vc}(q_{thi-1} - q_{thi})} - 1 \right)^2 \quad (15)$$

Having calculated \dot{s}_{gen} , the governing equation of heat conduction in thermal domain is closed. It is clear that the amount of entropy generated inside a segment is a function of the state variable, q_{thi} , material characteristics and geometrical parameters of the segment. By this stage, the extracted mathematical model is capable to capture the dynamics of thermal conduction in a transient process. However, to enhance the capability of the model to be used for multi-physical system, the generated model will not be suitable unless the compatibility consideration of the model has been taken into account.

IV. PORT BASED HEAT CONDUCTION COMPATIBLE DISCRETE MODEL

For the generalized thermal model obtained in Section III, the multi-domain compatible characteristics of the energetic elements will need to be generated. The generated compatible model can then be directly connected to other physical domains which are identically reticulated. To achieve this, unlike the conventional physical thermal element which can only obtain an optional property (such as capacity or resistivity) with respect to the location of the element inside the model, each suggested thermal element is required to have its own independent properties and internal energy elements in a way such that the boundaries of the internal energy elements symmetrically become congruous with the boundary of the segment. This requirement, regardless of the position of the element inside the structure, provides a physical connection between thermal internal energy elements and other corresponding energy elements of other physical domains if the same discretization is employed. This capability makes the thermal model of the system effortlessly connectable to other physical domain models such as the elastic, electrical, or chemical, and thus suitable for multi-physical dynamic investigations.

A series of the suggested configuration of the domain-independent compatible thermal element is shown in Fig. 4. In this configuration, it is assumed that heat can be stored in the C store part of the element, and can be dissipated while passing from one element to its adjacent element. On the basis of this assumption, for a 1D beam element, it has been

presumed that the center part of each element is the heat storage of the system where the memory characteristics belong to, and the two sides of each element are the parts in which the thermal energy is dissipated according to the Fourier constitutive equation.

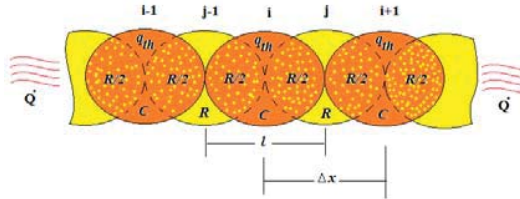

Fig. 4 1D heat conduction schematic

The bi-dissipative consideration of each suggested thermal element makes it slightly different from a conventional thermal element. According to the conventional representation (RC-chain), thermal energy can be stored in one side and dissipated from the other side of the element. This technique of discretization does not provide the power divergence information for each element, and thus the integration will not be achievable locally. This limitation makes the conventional models not suitable for parallel computation.

To generate the suggested thermal element, it is assumed that each segment of the system consists of both the dissipative and storage energy elements. Unlike the conventional element the dissipation of each thermal element is considered to be symmetrical with respect to the geometry of the element. To generate the symmetric dissipation for each element, and at the same time to maintain the continuity of the flux in a continuous geometry, the dual-shifted continuous reticulation of energy elements shown in Fig. 4 can be beneficial. Given the boundary of each thermal element is bonded to move together with the adjacent elements, one can relate the dissipative behavior of each element to the dissipative mechanism of its adjoint boundaries known as the junction elements indexed by j . Considering the existing shifting between storage element and resistive elements in the reticulated geometry, the dissipative characteristics of each junction elements can be produced by the dissipative parameters of the adjacent elements. This means that to generate the required flux crossing the boundary of each element, the local information can be employed. Therefore, dissipative parameters of each junction can be provided with respect to the material and the geometry properties of each element which leads to the generation of a locally-integrative thermal element.

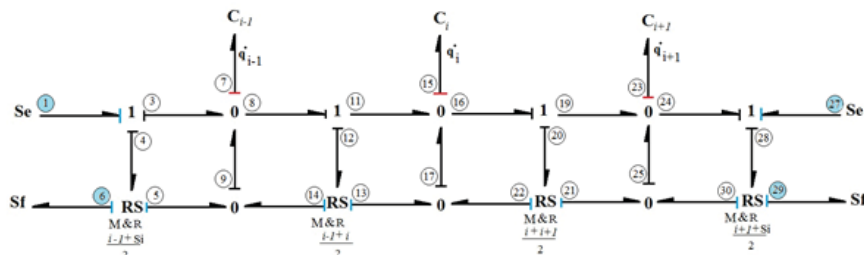

Fig. 5 1D conduction BG model

The BG presentation of Fig. 4 is shown in Fig. 5. As can be seen, in the represented model, each element is considered as a C store element with the state variable, q_{th} , denoting the amount of stored entropy. In the suggested BG model, each C element is connected to its adjacent elements via two intra-connection elements named earlier as junction elements. Assume that each element named after each junction element. As shown in Fig. 5, the characteristics of the junction elements are a weighted combination of its adjacent elements or the source and adjacent elements. Accordingly, one can assume that the generated entropy within each element can be obtained from a combination of the generated entropy of its adjacent junctions. Hence:

$$\dot{S}_i^{gen} = M_{j_i} \dot{S}_j^{gen} + M_{j_{i+1}} \dot{S}_{j+1}^{gen} \quad (16)$$

where \dot{S}_i^{gen} is the amount of internal entropy generation denoting the irreversibility of the heat conduction process, and M_j is the switch working after each RS elements. This

switch is responsible to conduct \dot{S}_j^{gen} to the correct direction by comparing the neighborhood temperatures together. As such:

$$\text{If } T_{i-1} < T_i \Rightarrow \begin{bmatrix} M_{j_i} \\ M_{j_r} \end{bmatrix} = \begin{bmatrix} 0 \\ 1 \end{bmatrix} \quad (17)$$

The net entropy generation for each element can be obtained as:

$$\dot{S}_i^{gen} = T_0 e^{\frac{1}{V_c}(q_{n_i} - q_0)} \left(\frac{M_{j_r}}{R_j} \left(e^{\frac{1}{V_c}(q_{n_{i-1}} - q_{n_i})} - 1 \right) + \frac{M_{j_{i+1}}}{R_{j+1}} \left(e^{\frac{1}{V_c}(q_{n_i} - q_{n_{i+1}})} - 1 \right) \right)^2 \quad (18)$$

To formulate the RS elements in the suggested configuration, one should first make a weighted function. For simplicity, the mean functionality is selected for calculating the junction resistance:

$$R_j = \frac{R_{i-1} + R_i}{2} \quad (19)$$

As it is explained earlier the constitutive equation related to the R elements in the classical thermodynamic is the Fourier equation. Considering (10) for the j th junction, the resistivity can be obtained as:

$$R_j = \frac{T_0}{2} \left(\frac{I_{i-1} e^{\frac{1}{\lambda_{i-1} A_{i-1}} (q_{th i-1} - s_0)}}}{\lambda_{i-1} A_{i-1}} + \frac{I_i e^{\frac{1}{\lambda_i A_i} (q_{th i} - s_0)}}}{\lambda_i A_i} \right) \quad (20)$$

Considering the compatible entropy generation, \dot{S}_i^{gen} and the resistivity of the system, R_j , the governing equation for the port-based thermal element can be rewritten as:

$$\dot{q}_{th i} = \frac{\left(\frac{1}{e^{-\frac{1}{\lambda_{i-1} A_{i-1}} (q_{th i-1} - s_0)}} - e^{\frac{1}{\lambda_i A_i} (q_{th i} - s_0)}} \right)}{\left(\frac{1}{2} \left(\frac{1}{\lambda_{i-1} A_{i-1}} e^{\frac{1}{\lambda_{i-1} A_{i-1}} (q_{th i-1} - s_0)}} + \frac{1}{\lambda_i A_i} e^{\frac{1}{\lambda_i A_i} (q_{th i} - s_0)}} \right) \right)} \frac{\left(e^{\frac{1}{\lambda_i A_i} (q_{th i} - s_0)}} - e^{-\frac{1}{\lambda_{i+1} A_{i+1}} (q_{th i+1} - s_0)}} \right)}{\left(\frac{1}{2} \left(\frac{1}{\lambda_i A_i} e^{\frac{1}{\lambda_i A_i} (q_{th i} - s_0)}} + \frac{1}{\lambda_{i+1} A_{i+1}} e^{-\frac{1}{\lambda_{i+1} A_{i+1}} (q_{th i+1} - s_0)}} \right) \right)} + e^{\frac{1}{\lambda_i A_i} (q_{th i} - s_0)}} \left(\frac{M_{jr} \left(\frac{1}{e^{-\frac{1}{\lambda_{i-1} A_{i-1}} (q_{th i-1} - s_0)}} - 1} \right)^2}{\left(\frac{1}{2} \left(\frac{1}{\lambda_{i-1} A_{i-1}} e^{\frac{1}{\lambda_{i-1} A_{i-1}} (q_{th i-1} - s_0)}} + \frac{1}{\lambda_i A_i} e^{\frac{1}{\lambda_i A_i} (q_{th i} - s_0)}} \right) \right)} \right) + \frac{M_{j+1} \left(\frac{1}{e^{\frac{1}{\lambda_i A_i} (q_{th i} - s_0)}} - 1} \right)^2}{\left(\frac{1}{2} \left(\frac{1}{\lambda_i A_i} e^{\frac{1}{\lambda_i A_i} (q_{th i} - s_0)}} + \frac{1}{\lambda_{i+1} A_{i+1}} e^{-\frac{1}{\lambda_{i+1} A_{i+1}} (q_{th i+1} - s_0)}} \right) \right)} \right) \quad (21)$$

It is clear that the rate of the change in the entropy of each element, according to the direction of heat conduction, absolutely depends on the material and geometrical characteristics of a spatial element. This exclusivity of the suggested model makes the thermal element compatible with any other domains' element with the same spatial references.

Accordingly, the generated model is suitable to be used in multi-physical domain dynamic investigations. For instance, in thermo-mechanical phenomena, it is known that mechanical loading can change the conductivity of the system. Considering (10), the resistance of each element is proportional to the length of its resistors' generalized length (Δx_i). Under mechanical load, this parameter of the system will vary during the thermal process which can affect the conductivity of the system. By replacing the RS elements with a mechanically modulated resistivity, MRS , the impacts of mechanical deformation can be captured in conductive behavior of the system. By means of a compatible 1D BG representation of the elastic domain with the suggested thermal model, the impact of elastic vibration on the conductivity of the system can be obtained from the connectivity of the system depicted in Fig. 6. It should be mentioned that the complete set of connections of thermal and elastic domain is not limited to what shown in Fig. 6, however the consideration of other connections is out of the interest of this paper.

V. 1D CONDUCTION DYNAMIC SIMULATION

Implementing the suggested model in Section IV, the dynamic behavior of thermal conduction within a beam structure is analyzed. Two steps are taken: (i) To evaluate the ability of the proposed thermal BG model in heat conduction dynamic modeling, a set of simulations including temperature pulse input and periodic thermal loading is performed for a simple beam structure that mimics an arbitrary spool; (ii) To evaluate the compatibility of the suggested thermal elements with other physical domains, the elastic domain impact on heat conduction is investigated for the chosen structure. The geometrical and material parameters of the beam are given in Table I, and the 1D heat conduction dynamics of the beam are to be investigated. To generate the discretized geometry, the chosen beam is reticulated into 20 uniform elements with the first and last elements being the boundary elements that can receive thermal input. It is assumed that the side surface of the beam is fully isolated and the beam is stress-free initially in the ambient room temperature. Sequentially, by employing temperature input in Fig. 7 the validity of the generated model in presenting thermal dynamics of the beam is first checked in Figs. 8-10. The capability of the model in capturing the dynamics of the thermal domain under periodic loading is then presented in Figs. 12, 13 with respect to the given periodic temperature input shown in Fig. 11. Finally, to check the compatibility of the generated thermal element with the elements of the elastic domain, the impact of thermal expansion on heat conduction is presented in Fig. 14 via

coupling the thermal model with the elastic model presented in [16].

To evaluate the capacity of the generated model in capturing the dynamics of the thermal domain, the pulse temperature input shown in Fig. 7 is considered as the boundary input of the left side of the beam. It is shown that, after 5 seconds, the left boundary temperature is risen to 398K for a period of 5 seconds and then drops down to the room temperature and stays there for the rest of the simulation time.

Length	l	$2.1e^{-1}m$
Cross section	A	$1e^{-4}m^2$
mass	m	$5.67e^{-2}kg$
Conductivity	λ	$2.73e^2 \frac{J}{m.K}$
Density	ρ	$4e^3 \frac{kg}{m^3}$
Molar mass	M	$2.698e^{-2} \frac{kg}{mol}$
Reference entropy @ 298K	s_0	$2.83e^1 \frac{J}{mol.K}$
Specific heat	c_p	$8.97e^2 \frac{J}{kg.K}$

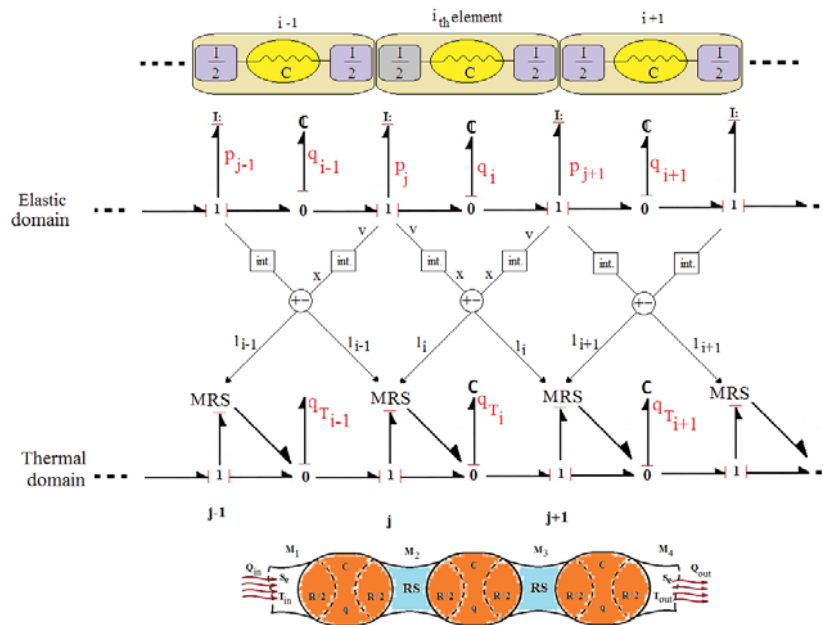

Fig. 6 Geometrical connectivity of thermal and elastic domains

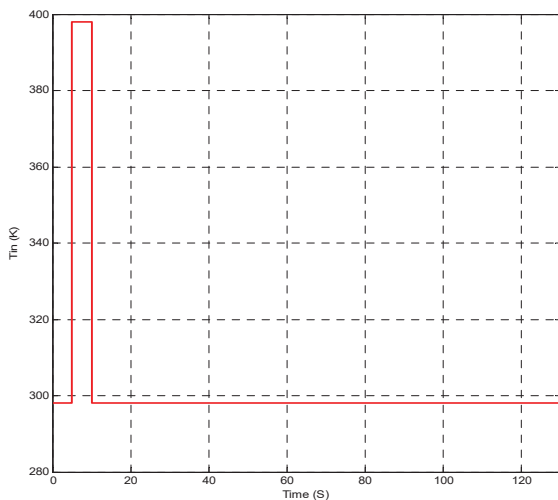

Fig. 7 Temperature input to the left side of the beam

Fig. 8 shows the temperature profile of different elements during the simulation time. The relaxing dynamics of the conduction are evident in this behavior. The temperature of each element rises one after another, and decreases with a different pattern from the rise period. To explain this, one can consider that after the input pulse is vanished at 10 seconds, the heat flow in the system is reversed such that the boundary elements start releasing heat to the environment and to the rest of the system. Fig. 9 shows the entropy flow changes inside the system with respect to the considered input. The behavior of the entropy flow can vividly explain the resultant temperature profile of the system. As can be seen, neglecting the boundary element, the reversed entropy flow in the system is not as strong as its primary current. Therefore, the cooling process is to some extent slower than the heating process in this situation.

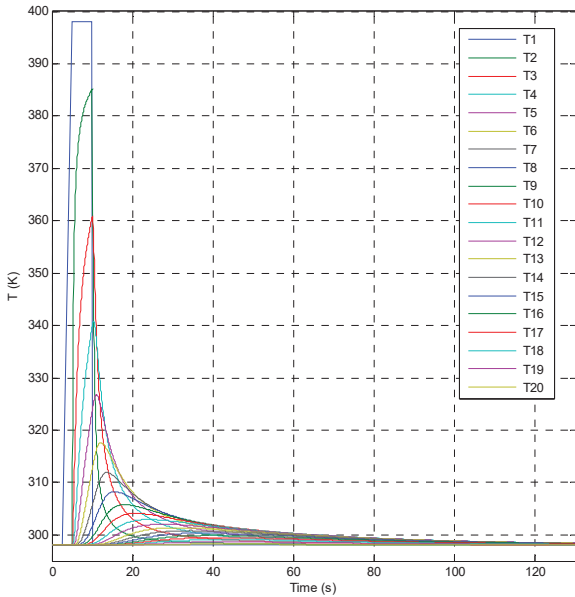

Fig. 8. Beam elements' thermal behavior

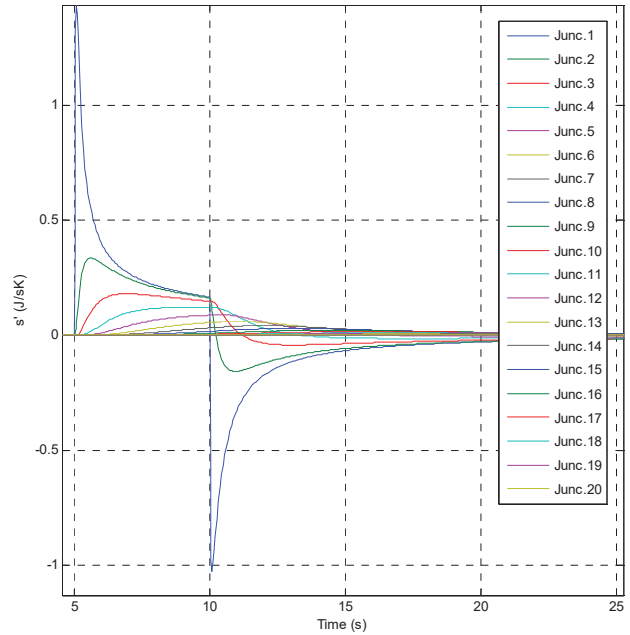

Fig. 9. Junction entropy flows

Fig. 10 shows the amount of generated entropy rate during this process. The dissipated energy generated from the resistivity of the system can return to the system via this generated entropy rate which can alter the dependent variable of the system, T . Accordingly, one can conclude that the resultant thermal dynamics of the system in principle can be presented as a result of both the irreversible entropy rate and the net reversible entropy rate (shown in Fig. 9) for each element.

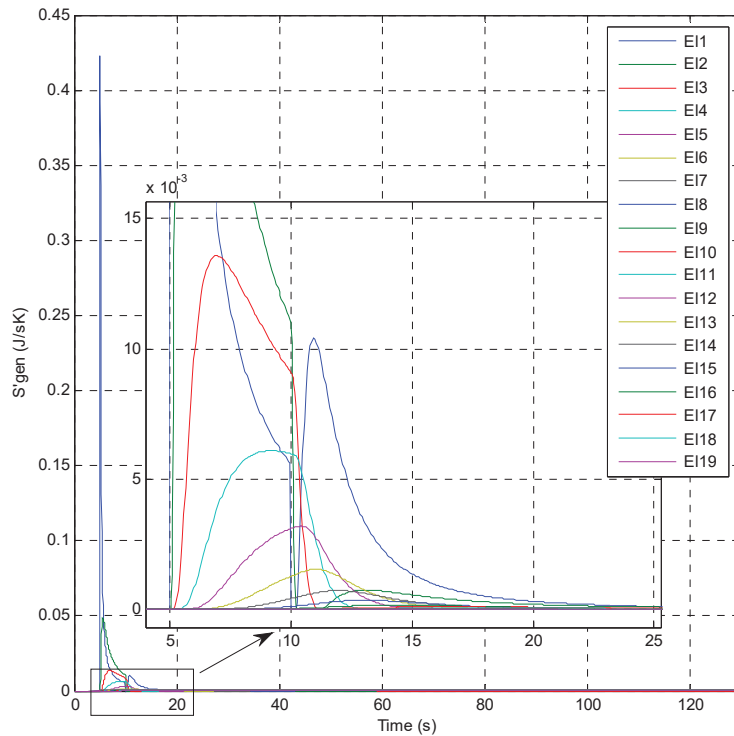

Fig. 10. Entropy generation in each element induced by temperature pulse input

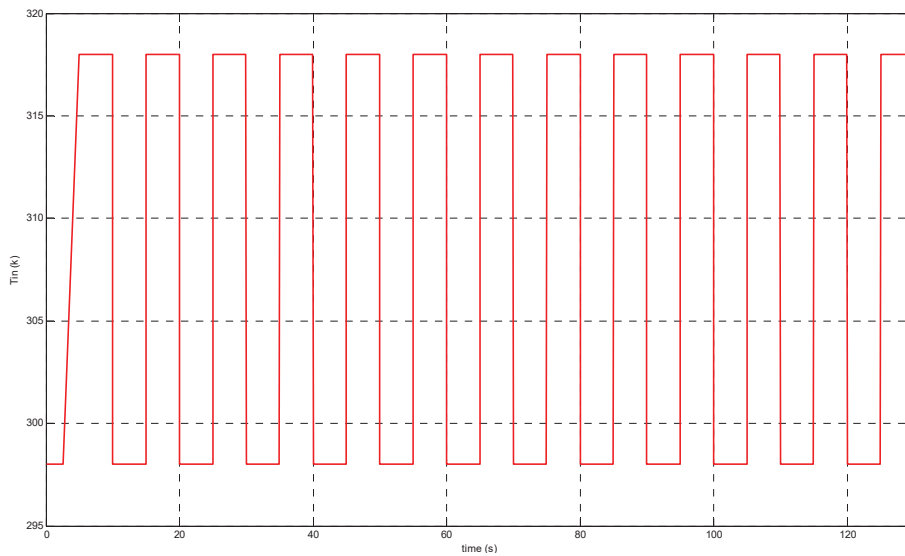

Fig. 11 Periodic thermal pulse input

A close examination to the magnified section of Fig. 10 shows that for the first set of beam elements, the profile of the irreversible entropy generation contains two peaks, whereas the transmitted heat pulses was unique. One can explain that the first peak is a definite result of the external-pulse resultant temperature gradient and the second peak is induced by the internal dynamics of the system during the cooling period. This result clearly shows the rules of the internal dynamics in the total behavior of the system.

To check the ability of the suggested model under periodic loading, a periodic thermal input shown in Fig. 11 is considered to be applied to both ends of the beam. Fig. 12 shows the resultant thermal behavior of the beam. As can be seen, the side elements of the beam are acting as a thermal filter for the central elements of the beam. This behavior highlights the slow dynamics of the thermal domain. As mentioned earlier, this dynamic behavior is the result of the thermal domain extensive variable exchange between elements. The reversible and irreversible entropy flow of the system is shown in Fig. 13. The magnified section clearly shows the internal flow difference between the side elements and the central element, which results in the formation of the obtained temperature profile of the system.

To check the compatibility of the suggested thermal model with the elastic domain, the impact of elastic deformation on the conductivity of the chosen beam is to be examined. To achieve this, consider the geometrical connectivity shown in Fig. 6. The impact of the dilation of the system on this conductivity is to be discussed. To include the dilation, the compatible elastic BG model presented in [17] was employed. A temperature pulse shown as T_{in} in Fig. 14 (a) is considered as the input signal to the left boundary of the beam. Accordingly, the impact of the expansion of the element on its conductivity is presented in Fig. 14 via highlighting the difference in system behaviors between the fixed and expansive geometry situations. Fig. 14 (b) indicates a slight

lag in the temperature rise of the expanded elements. This phenomenon can be explained by the amount of increase in the reversible and irreversible entropy rate, as the temperature of each element is dependent on the accumulated entropy of the element. This dependency is clearly reflected in Figs. 14 (c) and (d). A rational reason to justify this result can be obtained from (6) and (19) which denote an invert relativity of entropy flow with growing resistivity. According to (21), as the resistivity of the expanding section increases, the internal entropy flow decreases, and consequently the temperature of the element rises.

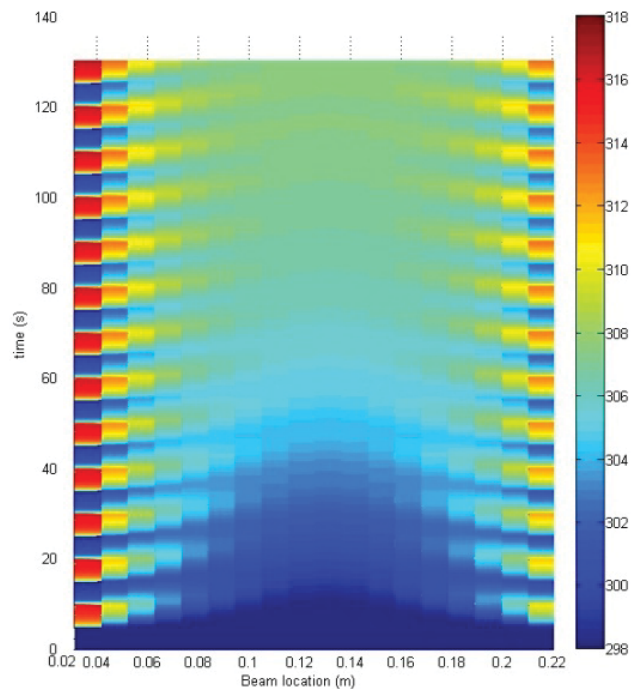

Fig. 12 Temperature contour alongside the beam during the periodic thermal pulse input from both ends

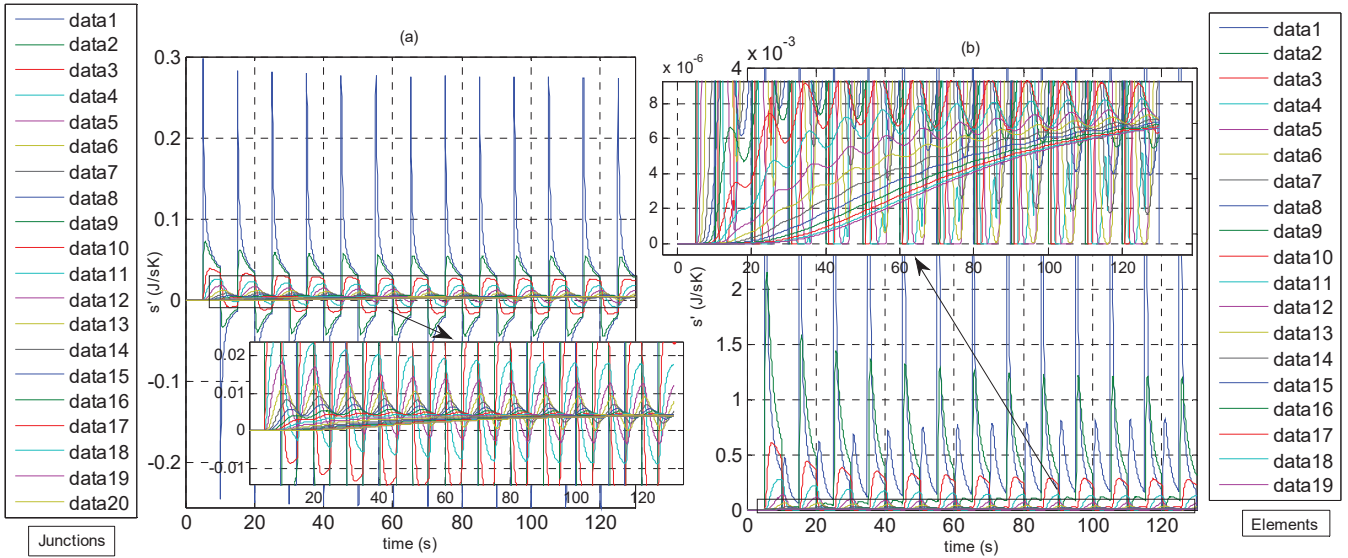

Fig. 13 (a) Reversible entropy flow; (b) Irreversible entropy flow

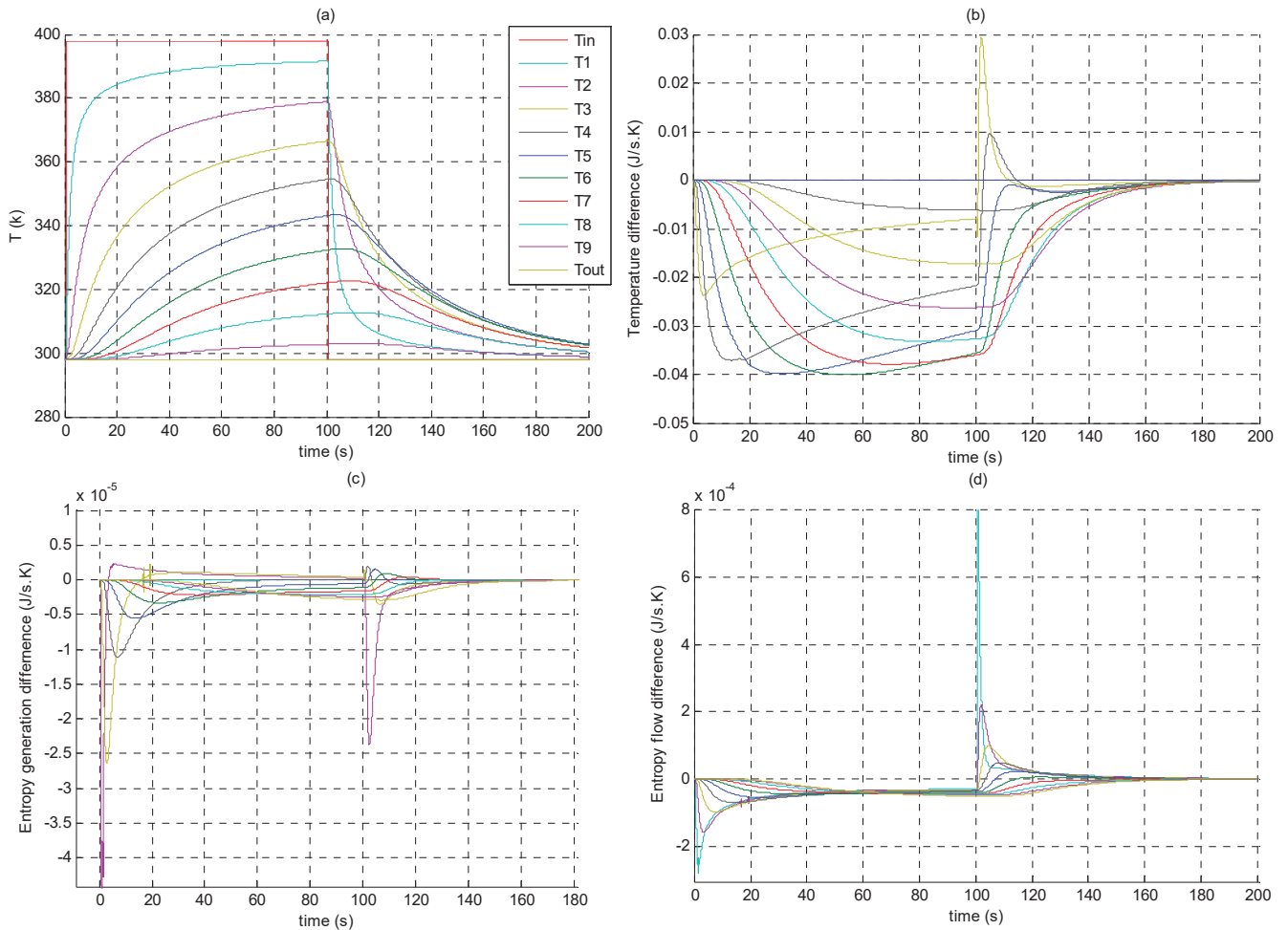

Fig. 14 Expansion impact on system conductivity: (a) Element temperature change due to pulse input at left side; (b) Difference in thermal behavior between fixed and expansive geometry situations; (c) Difference in entropy generation; (d) Difference in reversible entropy flow

The simulation results shown in this section indicates that the expansion of the system can change the conductivity of the

system, however the relation between thermal domain and elastic domain is weak. Hence, in many applications, this

relation can be negligible unless a high temperature control performance is required. For instance, in the lithography printing systems of the ASML machines the temperature needs to be controlled within the range of 1 mK in order to provide the printing ability in the order of Pico meter. In this case, the designer will be required to take the internal dynamics of the conduction of the system into account.

VI. CONCLUSION

In this paper to investigate the dynamics of heat conduction in multi-physical phenomena, a new configuration of energy element to form a domain independent compatible thermal element is suggested. Using this configuration in a multi-physical domain setting, the impact of the thermal domain dynamics on the total dynamics of the system can be examined. This method provides a useful tool for the management of the energy consumptions in multi-disciplinary systems where temperature control is an important issue.

The discrete nature of the suggested thermal model is also ideally matched with parallel computation platforms that can reduce the time cost of the simulations significantly. This advantage can increase the likelihood of the suggested model in the development of control strategies.

The simulation results indicate the capability of the suggested model in capturing the dynamic behavior of the thermal domain in different situations. The obtained results also confirm the slow and relaxing behavior of the conduction in the system which is well-matched with the essential features of the thermal domain.

The thermoelastic simulated results illustrate that despite of weak connectivity between the elastic and thermal domains, the suggested model is able to capture the impact of multi-physical phenomena on the thermal domain and vice versa.

It should be mentioned that all possible connections of the elastic and thermal domains have not been fully summarized here, as examinations of the further connections existing between the system subdomain storage elements would require the use of multiple storage energy elements. Since the aim of this paper is to investigate the dynamics of conduction with respect to its dissipative energy elements, the consideration of multiple storage is beyond the scope of this paper.

REFERENCES

- [1] F. Cellier, *Continuous System Modeling*, New York: Springer-Verlag, 1991.
- [2] w. k. Nowacki, "Progress in Thermoelasticity," *European Mechanics Colloquium*, 1967.
- [3] J. Thoma, *Simulation by Bond graph*, Verlag: Springer, 1990.
- [4] A. Mukherjee, R. Karmakar, *Modeling and Simulation of Engineering Systems through Bond graph*, New Delhi, India: Narosa Publishing House, 2000.
- [5] D.C. Karnopp, R.C. Rosenburg, *System Dynamics: A Unified Approach*, Wiley Inter sciences, 1975.
- [6] H. Afshari, A. Zanj, "Dynamic Analysis of a Nonlinear Pressure Regulator Using Bond graph Simulation Technique," *Journal of Simulation Modeling Practice and Theory*, 2010.
- [7] A. Zanj, H. Karimi, A.J. Gholi, M. Shafiee, "Dynamic Modeling of Indirect Hydro-Control Valve – Bond graph Approach," *Journal of Simulation, Modeling, Practice and Theory*, 2012.

- [8] E. L. Wilson, *Three-Dimensional Static and Dynamic Analysis of Structures*, California: Computers and Structures, Inc, Berkeley, 2002.
- [9] H. F. Brinson, L. C. Brinson, "Stress and Strain Analysis and Measurement," in *Polymer Engineering Science and Viscoelasticity an Introduction*, Springer, 2008, pp. 16-53.
- [10] J. Peraire, P. O. Persson, "High-Order Discontinuous Galerkin Methods for CFD, In *Adaptive High-Order Methods in Computational Fluid Dynamics*," World Scientific series in Advances in Computational Fluid Dynamics, vol. 2, pp. 119-152, 2010.
- [11] W. Borutzky, *Bond Graph Methodology: Development and Analysis of Multidisciplinary Dynamic System Models*, Springer, 2010.
- [12] P. Breedveld, *Physical System Theory in Terms of Bond graphs*, Enschede: University of Twente, 1984.
- [13] J. U. Thoma, *Simulation by Bondgraph*, Springer, 1990.
- [14] A. Mukherjee, R. Karmakar, *Modeling and Simulation of Engineering System through Bondgraph*, New Dehli: Narosa Publishing House, 2000.
- [15] D.C. Karnopp, R.C. Rosenburg, *System Dynamics: A Unified Approach*, Wiley Inter sciences, 1975.
- [16] A. Zanj, F. He " A Thermomechanical Enhanced Elastic Model: Bond Graph Approach," *23rd International Congress on Sound and Vibration*, Athens, Greece, July, 2016.
- [17] A. Zanj, H. Afshari, "Dynamic Analysis of a Complex Pneumatic Valve Using Pseudobond Graph Modeling Technique," *Journal of Dynamic System, Measurement, and Control*, vol. 135, no. 3, 2013.