

Development and Evaluation of a Portable Ammonia Gas Detector

Jaheon Gu, Wooyong Chung, Mijung Koo, Seonbok Lee, Gyoutae Park, Sangguk Ahn, Hiesik Kim, Jungil Park

Abstract—In this paper, we present a portable ammonia gas detector for performing the gas safety management efficiently. The display of the detector is separated from its body. The display module is received the data measured from the detector using ZigBee. The detector has a rechargeable li-ion battery which can be use for 11~12 hours, and a Bluetooth module for sending the data to the PC or the smart devices. The data are sent to the server and can access using the web browser or mobile application. The range of the detection concentration is 0~100ppm.

Keywords—Ammonia, detector, gas safety, portable.

I. INTRODUCTION

THE gases are typically classified into three types of compressed, liquefied, and dissolved gases according to the management condition (physical state). Also, the gases are classified as combustible, supporting, and non-combustible gases depending on the nature of the gas. In addition, the gases are categorized as a toxic gas and non-toxic gas depending on the harmful risk of human [1]. Among them, the toxic gases are ammonia, chlorine, hydrogen chloride, and etc. [2]. When the ammonia gas is leaking, it stimulates nose and throat, and causes keratitis, bronchitis, etc. Therefore, in this paper, we design a detector for checking the leakage of ammonia gases used in the refrigeration facilities efficiently and want to spread the gas safety field through the corporate support. This detector includes the technique to guarantee the durability of three years and algorithms to improve the measurement accuracy within $\pm 3\%$ F.S(vol). The measured data of gas concentration can be transmitted to the smart devices using the Bluetooth communication. The transmitted data can be sent to the server and it is possible to manage the data by web or mobile applications.

The structure of this detector is a detachable structure. Its detection part with sensor and display's part can be separated.

Jaheon Gu is with J2PLUS Co., Ltd., Gunpo, Korea (the first author to provide phone: +82-31-366-1510; fax: +82-31-8086-7106; e-mail: jaheon@j2plus.com).

Wooyong Chung and Mijung Koo are with J2PLUS Co., Ltd., Gunpo, Korea (e-mail: wooyong1969@j2plus.com and sissy@j2plus.com).

Seonbok Lee is with Embedded Solutions Co., Ltd., Chungju, Korea (e-mail: sblee@eslinux.co.kr).

Gyoutae Park is with the Institute of Gas R&D Center, Korea Gas Safety Corporation, Chung-buk Korea (corresponding author to provide (e-mail: gtparkgs@kgs.or.kr).

Sangguk Ahn is with RFEngine. Co., Ltd., Gwangmyong, Korea (e-mail: sgahn@rfengine.co.kr).

Hiesik Kim is with University of Seoul, Seoul, Korea (e-mail: drhskim@uos.ac.kr).

Jungil Park is with Yeungnam University, Gyeongsan, Korea (e-mail: jipark@yu.ac.kr)



When the display part is separated from the body, it can be displayed by receiving the measured data using the Bluetooth communication. At the same time, it can check and transmit the measured data by using the applications in the smart devices.

II. DEVELOPMENT OF A PORTABLE AMMONIA GAS DETECTOR

A. Domestic Development Status and Practices

Table I shows an example of the ammonia detectors developed in Korea.

TABLE I
CASE OF THE DOMESTIC PRODUCTS



Product	Company	Characteristics
	Gas En Tech	- Measuring gases: NH ₃ , CO, etc. - Explosion proof (Ex d □c T6) - Electrochemical sensors
	GAStron	- Measuring gases: NH ₃ , CO, etc. - built-in LCD Display - Electrochemical sensors

The above products have used electrochemical sensors. Lifespans of gas detectors using combustible, electrochemical and semiconductor type sensors are maximum three years. While these sensors have been used at KGS for about two years, they are several disadvantages against a dramatic drop in accuracy.

B. Foreign Developments and Practices

Table II shows an example of the ammonia detectors developed abroad [3], [4]. Both types of detectors can measure the compound gases containing ammonia gas and received an intrinsic safety enclosure.

TABLE II
CASE OF THE FOREIGN PRODUCTS

Product	Company	Characteristics
	Dräger	- Measuring gases: NH ₃ , CO, etc. - Dual infrared sensor - Response time: 20sec - European, international, north America explosion proof certification
	RAE Systems	- Measuring gases: NH ₃ , CO, etc. - Real-time wireless data communication - North America, Europe, china explosion proof certification

C. Development Objectives and Specifications of the Ammonia Gas Detector

Table III shows the specifications of the ammonia detector

and describes the specification such as measurement accuracy, measuring range and the battery life, etc. in detail. Also, Table III shows the method of communication when the display is separated and success rates of communication.

TABLE III
 SPECIFICATIONS OF THE AMMONIA DETECTOR

Topic	Target
Measurement accuracy	≤ ±3 %FS
Measuring range	5~200 ppm
Durability	≥ 3 years
Stabilization response time (T90)	≤ 35 sec
Size of the battery pack	Within 7×5×2cm
Continuous operation times of battery	8 hr./day
Communication method	Bluetooth
Success rates of communication (10m)	99 %

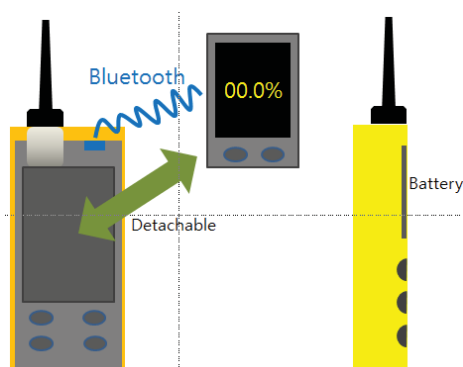

Fig. 1 Form of the ammonia detector

III. DESIGN OF THE AMMONIA GAS DETECTOR

A. Design of the Structure and Form of the Detector

Fig. 1 briefly shows the structure and shape of the ammonia detector. The display part is a detachable structure and transmits the gas concentration data using Bluetooth communication when this part is separated. The back of the body is designed in the form of a handy type grip to prevent slipping when caught by hand.

B. Design of the Hardware Circuitry

Fig. 2 shows the system block diagram of the ammonia detector. The left side shows the display part and the right side shows the detection part to measure ammonia gases.

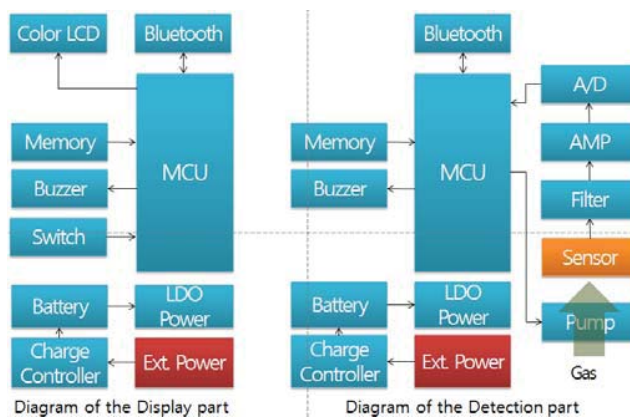

Fig. 2 System block diagram of the ammonia detector

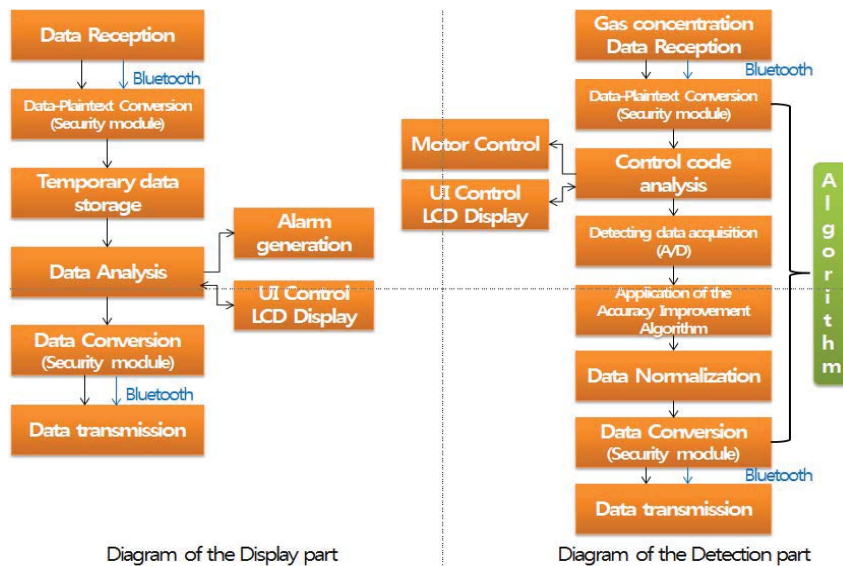

Fig. 3 Algorithms of the ammonia detector

C. Design of the Software Algorithms

Fig. 3 shows the software algorithms of the ammonia detector. When analyzing the data of the detected ammonia gases, the characteristic equation for all data is derived such as (1). Then, the slope of the line “s” and y-axis intercept “h” is obtained by using linear regression function [5].

$$y = sx + h \quad (1)$$

At this time, it was determined by using the least square method [6]. The slope and y-axis intercept are obtained in the direction in which the sum of the square of the standard

deviation is minimized with respect to the n data. Obtaining process is shown from (2)-(6):

$$M^2 = \sum [Y_i - f(X_i, d_1, d_2, \dots, d_n)]^2 \quad (2)$$

$$\frac{\partial(M^2)}{\partial d_i} = 0 \quad (3)$$

$$M^2(s, h) \equiv \sum_{i=1}^n [Y_i - (sX_i + h)]^2 \quad (4)$$

$$\frac{\partial(M^2)}{\partial h} = -2 \sum_{i=1}^n [Y_i - (sX_i + h)] = 0 \quad (5)$$

$$\frac{\partial(M^2)}{\partial s} = -2 \sum_{i=1}^n [Y_i - (sX_i + h)] X_i = 0 \quad (6)$$

when (5) and (6) are solved, (7) and (8) are derived respectively. Then, when simultaneous (7) and (8) are solved, (9) and (10) are derived.

$$nh + s \sum_{i=1}^n X_i = \sum_{i=1}^n Y_i \quad (7)$$

$$h \sum_{i=1}^n X_i + s \sum_{i=1}^n X_i^2 = \sum_{i=1}^n X_i Y_i \quad (8)$$

$$h = \frac{\sum_{i=1}^n Y_i \sum_{i=1}^n X_i^2 - \sum_{i=1}^n X_i \sum_{i=1}^n X_i Y_i}{\Omega} \quad (9)$$

$$s = \frac{\sum_{i=1}^n X_i Y_i - \sum_{i=1}^n X_i \sum_{i=1}^n Y_i}{\Omega} \quad (10)$$

$$\Omega = n \sum_{i=1}^n X_i^2 - \sum_{i=1}^n X_i \sum_{i=1}^n X_i \quad (11)$$

As described above, the input-output response characteristics can be applied to derive the best calibration curve equation using the linear regression function. However, some sections will remain the error. The value of errors can be corrected by the numerical analysis.

In this paper, we obtained an approximation function for measuring the unknown gas concentration input from the standard data obtained experimentally using Neville interpolation. Using this interpolation, we designed to obtain the non-measured data by the Neville interpolation.

Neville interpolation is based on the Newton method and is defined as recursive algorithm [7]. In different sets of n+1 data

points, the interpolation polynomials are up-to nth-order polynomial and have the following properties:

$$p(x_i) = y_i \text{ for all } i = 0, \dots, n \quad (12)$$

when k is i, i+1, ..., j, we defined p_{ij} as the j-ith order equation passing through the point (x_k, y_k). Then, p_{ij} satisfies (13), (14):

$$p_{i,i}(x) = y_i, \quad 0 \leq i \leq n \quad (13)$$

$$p_{i,j} = \frac{(x - x_j) p_{i,j-1}(x) + (x_i - x) p_{i+1,j}(x)}{x_i - x_j}, \quad 0 \leq i < j \leq n \quad (14)$$

Using these equations, we calculated an equation p_{0,n}(x) to look for unknown some values. Therefore, as a result of using the Neville interpolation, we found the best approximation line closed to linear equation by correcting several errors. Fig. 4 shows the scene of performance test of a prototype ammonia detector. Table IV shows measuring test result of our developed prototype ammonia detector with our designed algorithm by using Neville Interpolation. Errors ranges of our prototype ammonia detector are within ±5.0 FS. Here, full scale is 60 ppm. This is first year objective in our research project. Final objective is ±3.0 FS. Fig. 5 shows graph of measured concentration data for according to injecting ammonia standard gases made by 5.45, 30.7, and 61.3 ppm. Output line of a prototype ammonia detector is comparably approximating the line of concentration standard gases.



Fig. 4 Performance test of a prototype ammonia detector

TABLE IV
 CONCENTRATION TEST OF A PROTOTYPE AMMONIA DETECTOR

Measurement	Standard	Differences	%FS
2.5	5.45	2.95	-4.92%
27.8	30.7	2.9	-4.83%
63.6	61.3	-2.3	3.83%

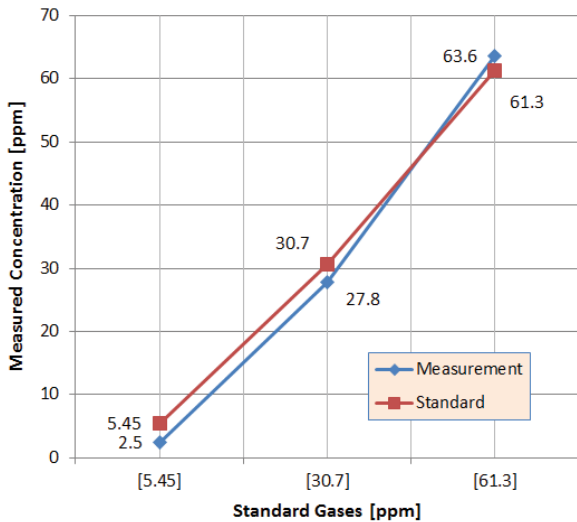

Fig. 5 Graph of measuring data of a prototype ammonia detector

IV. CONCLUSION

In this paper, we proposed the basic designs for developing the portable ammonia detectors for efficient gas safety management in the refrigeration facilities where ammonia gases are used. We designed the back of the body in the form of a handy type grip to prevent slipping when caught by hand and conveniently carry. Also, the display part is designed to be detachable so we created the measurement environment that inspectors can be protected from the danger. Furthermore, the detectors can transmit the measured data to the smart devices using the Bluetooth communication and manage the data in the long term by sending the data frequently to smart devices.

According to our designs, we manufactured a prototype ammonia detector through applying our proposed algorithm by using Neville interpolation. We, also, demonstrated good approximation line for the measured result that has the standard gases correspondences.

In the near future, we will add the intrinsically safe circuit and outstanding performances such as accuracy, response time, and durability.

We hope a larger help to the gas safety management fields by distributing the highly trusted ammonia detectors.

ACKNOWLEDGMENT

This research was supported by the Ministry of Trade, Industry & Energy Project "Development of Smart Gas Leak Measuring Instrument and Performance Test Technology", Serial Number R0003355.

REFERENCES

- [1] Incident Investigation & Safety Checkup Division, Gas Incident Statistics, Korea Gas Safety Corporation, 2015.
- [2] Marc J. Assael and Konstantinos E. Kakosimos, Fires, Explosions, and Toxic Gas Dispersions: Effects Calculation and Risk Analysis, CRC Press, 2010.
- [3] Dräger, Dräger X-am 5600 approved as type MQG 01** Multi-Gas Monitor Technical Handbook, Dräger Co., 2015.
- [4] RAE Systems, MultiRAE's User Guide, Rae Systems Co., 2015.
- [5] Jon S. Wilson, Stuart Ball, Creed Huddleston, Edward Ramsden, and

Dogan Ibrahim, Test and Measurement: Know It All, NEWNES, pp 466, 2008.

- [6] Gyoutae Park, Geunjun Lyu, Youngdo Jo, Jeongrock Kwon, Sangguk Ahn, Hiesik Kim, "A study on the Development and Accuracy Improvement of an IR Combustible Gas Leak Detector with Explosion Proof", KIGAS Vol.18, No.3, pp 1~12, 2014.
- [7] Anne Greenbaum and Timothy P. Chartier, Numerical Methods: Design, Analysis, and Computer Implementation of Algorithms, Princeton University Press, 2012.