

Design and Performance Analysis of One Dimensional Zero Cross-Correlation Coding Technique for a Fixed Wavelength Hopping SAC-OCDMA

Satyasen Panda, Urmila Bhanja

Abstract—This paper presents a SAC-OCDMA code with zero cross correlation property to minimize the Multiple Access Interference (MAI) as New Zero Cross Correlation code (NZCC), which is found to be more scalable compared to the other existing SAC-OCDMA codes. This NZCC code is constructed using address segment and data segment. In this work, the proposed NZCC code is implemented in an optical system using the Opti-System software for the spectral amplitude coded optical code-division multiple-access (SAC-OCDMA) scheme. The main contribution of the proposed NZCC code is the zero cross correlation, which reduces both the MAI and PIIN noises. The proposed NZCC code reveals properties of minimum cross-correlation, flexibility in selecting the code parameters and supports a large number of users, combined with high data rate and longer fiber length. Simulation results reveal that the optical code division multiple access system based on the proposed NZCC code accommodates maximum number of simultaneous users with higher data rate transmission, lower Bit Error Rates (BER) and longer travelling distance without any signal quality degradation, as compared to the former existing SAC-OCDMA codes.

Keywords—Cross Correlation, Optical Code Division Multiple Access, Spectral Amplitude Coding Optical Code Division Multiple Access, Multiple Access Interference, Phase Induced Intensity Noise, New Zero Cross Correlation code.

I. INTRODUCTION

TO meet the global demand for large bandwidth due to the growth of video and image-based services, HDTV and peer-to-peer services, recently an advanced multiplexing technique called Optical Code Division Multiple Access (OCDMA) has come into picture. It has its origins in Radio Frequency (RF) communications but, it's being applied to the optical domain due to a number of inherent advantages that the technique offers. Unlike Wavelength Division Multiplexing (WDM) that provides a dedicated wavelength per channel or Optical Time Division Multiplexing (OTDM) that requires strict synchronization between channels, OCDMA provides channels with asynchronous access to the available bandwidth. Hence, each channel transmission can overlap in both the time and wavelength domain, achieved

through the use of optical codes. Each channel is assigned a unique optical code that is impressed upon the data before it is transmitted. OCDMA has created immense interest in communication technology because of its asynchronous access capability, faster speed, efficiency, security and unlimited bandwidth. The performance of SAC-OCDMA is limited by Multiple Access Interference (MAI), and Phase Induced Intensity Noise (PIIN) noises. OCDMA offers several unique advantages such as asynchronous transmission, soft capacity on demand, the potential for secure transmission and quality of service control [1]-[3]. However, OCDMA does suffer from three main noise sources which can severely limit the system performances. MAI noise results from the improperly decoded channels passing through the decoder and being incident on the photo detector. This MAI limits the system performance as it scales with the number of channels. The second noise source is the Optical Beat Noise (OBN), which is a result of square law Photo detection used in the optical receiver. Since the photo detector receives the signals from each channel and these incident fields are mixed in the detector and produces beating that occupies the same bandwidth of the desired signal. The third noise source is the PIIN, which results due to the mixing of two uncorrelated light fields that has identical polarization, minimum self-intensity noise, same spectral property and equal intensity. Due to the PIIN the spectrum is widened beyond maximum electrical band width permissible, severely affecting the overall system performance. That is why, the recent research greatly concentrates on to develop OCDMA codes, which are required to minimize the MAI, OBN and PIIN. OCDMA system is employed in various types of networks like LAN, WAN and access network with sustainable performance [4]-[6]. Major OCDMA performance parameters such as the types of OCDMA codes, BER and the transmitted data rate play an important role in deciding the maximum number of users that are allowed to access any network asynchronously [7].

The OCDMA system performance is limited by different noise sources such as Gaussian noise, Shot noise, Beat noise, Thermal noise, Dark current, PIIN, and MAI arising from other users. Of these noises, the MAI and PIIN are generally considered as the dominating sources of noise [8]. SAC-OCDMA system offers a very good solution that reduces the MAI affects by utilizing specially designed codes with minimum in-phase cross correlation [9]. Lots of codes have

Satyasen Panda, PhD Scholar, is with the department of Electronics and Communication Engineering, IGIT, Sarang, India (e-mail: satyasenp@gmail.com).

Dr. Urmila Bhanja, Associate Professor, is with the department of Electronics and Communication Engineering, IGIT, Sarang, India (corresponding author; e-mail: urmilabhanja@gmail.com).

been developed in the literature for the SAC-OCDMA networks such as an Enhanced Double Weight (EDW) code [10], a Modified Frequency-Hopping (MFH) code [11], a Modified Quadratic Congruence (MQC) code [12], an Optical Orthogonal code (OOC) [13], a prime code [14], A Khazani-Syed (KS) code [15], a Random Diagonal (RD) code [16], a Modified Double Weight (MDW) code [17], a Dynamic Cyclic Shift (DCS) code [18], Multi Diagonal Code (MD) [19] etc. However, these codes suffer from several limitations such as the code length is often unreasonably long, the code construction is limited by various code parameters, the cross-correlation increases with increasing weight resulting higher BER. In addition, some of the SAC-OCDMA codes suggested in the literature do not support large number of simultaneous users, longer fiber distance or higher data rates for asynchronous communication. To overcome these problems in this paper, a code referred in this work as NZCC is suggested. The NZCC is designed by a single bit shifting operation of row vectors in a matrix. The proposed NZCC has several advantages like cross-correlation is zero that cancels the PIIN and OBN, flexibility in choosing the parameters such as code weight (W), length of the code (N) and number of users (K), a simple, flexible, effective and dynamic design, supports larger number of active users with higher dynamic data rates for longer distances for asynchronous transmission without affecting the system performance much and spectral characteristics of different active users do not overlap resulting in minimum cross correlation.

This paper is organized as follows. The design and construction of the proposed NZCC code is described in Section II. System performance analysis of the proposed code is explained in Section III. Simulation set up and observations of the design are provided in Section IV. Also Section IV provides the comparison of performance with respect to other OCDMA codes. Finally, conclusions are drawn in Section V.

II. THE PROPOSED NZCC CODE DESIGN

NZCC code is constructed by shifting each bit of the previous row by one bit to the right for generation of the next row of the code matrix. Here the number of users supported is the order of the matrix.

In an OCDMA system, the signature sequence or the code sequence consists of unipolar (0, 1) sequence. Generally, a code is denoted as (N, W, λ_c) where, N is the code length, W is the code weight and λ_c is the in-phase cross correlation. The cross correlation is defined as expressed in (1) [19]:

$$\lambda_c = \sum_{i=1}^N X_i Y_i \quad (1)$$

Many OCDMA code strategies are proposed where, the major concerns of designing the codes are to reduce the MAI, code length and code weight. However, in almost all the existing SAC-OCDMA codes, the code length increases with the increase in the number of users. As a result, the cross correlation becomes more than 1. To reduce the MAI the cross

correlation should be as small as possible. Therefore, in this work care has been taken to design a SAC-OCDMA code referred in this work as NZCC to reduce the code length, to keep the cross correlation zero and to keep the auto correlation maximum. In the proposed NZCC code, the center wavelength for each of the users can also be varied without altering the performance of the OCDMA system.

The following steps describe the construction of NZCC code for various orders.

A. NZCC Code for Number of Users (K) =3 and Weight W=2.

Step-1:

First we take a matrix of order 1 and weight 2. Order of the matrix represents the no of users. The first row and the first column of the matrix is always fixed at the value of '1'. The next '1' is placed at a distance of (K-1) from the first element (the first row and the first column) of the matrix. The size of the first row vector that is the code length (N) equals to K * W. In this case, the code length (N) is six.

$$A = [1 \ 0 \ 0 \ 1 \ 0 \ 0]$$

Step-2:

In this step, the next row vector that is the second row vector is obtained by right shifting the bit '1' of the first row vector to one place and similarly, the third row vector is obtained by right shifting the '1' bit of the second row vector to one place and the process is repeated.

As weight is 2, the final code for order 3 will be

$$Y = \begin{bmatrix} A \\ A_1 \\ A_2 \end{bmatrix} = \begin{bmatrix} 1 & 0 & 0 & 1 & 0 & 0 \\ 0 & 1 & 0 & 0 & 1 & 0 \\ 0 & 0 & 1 & 0 & 0 & 1 \end{bmatrix}_{3 \times 6}$$

where A_1 the one bit is right shifted version of A and A_2 is the one bit right shifted version of A_1 . Similarly, the code for weight "W"=3 and number of users "K"=4, the length of the code (N) will be N=K*W.

In this case,

$$A = [1 \ 0 \ 0 \ 0 \ 1 \ 0 \ 0 \ 0 \ 1 \ 0 \ 0 \ 0]$$

So, final code will be

$$Y = \begin{bmatrix} A \\ A_1 \\ A_2 \\ A_3 \end{bmatrix} = \begin{bmatrix} 1 & 0 & 0 & 0 & 1 & 0 & 0 & 0 & 1 & 0 & 0 & 0 \\ 0 & 1 & 0 & 0 & 0 & 1 & 0 & 0 & 0 & 1 & 0 & 0 \\ 0 & 0 & 1 & 0 & 0 & 0 & 1 & 0 & 0 & 0 & 1 & 0 \\ 0 & 0 & 0 & 1 & 0 & 0 & 0 & 1 & 0 & 0 & 0 & 1 \end{bmatrix}_{4 \times 12}$$

where K=4, N=12.

B. NZCC Code for “K” Users, Code Length “N” and Code Weight “W”

Step-1: Take a matrix of order 1xN

$$A = [1 \ 0 \ 0 \ 1 \ \dots \ N]$$

Step-2: The final code becomes:

$$Y = \begin{bmatrix} A \\ A_1 \\ A_2 \\ \vdots \\ A_{K-1} \end{bmatrix}_{K \times N}$$

Here the code length (N) = Code weight (W) X Number of user (K) = W * K.

C. The Final NZCC Code

$$Z = [D \ C];$$

where, D is the Data segment. C is the Code segment.

The NZCC code sequence for W=3, K=4 will be:

$$D = \begin{bmatrix} 1 & 0 & 0 & 0 \\ 0 & 1 & 0 & 0 \\ 0 & 0 & 1 & 0 \\ 0 & 0 & 0 & 1 \end{bmatrix}$$

$$C = \begin{bmatrix} 1 & 0 & 0 & 0 & 1 & 0 & 0 & 0 \\ 0 & 1 & 0 & 0 & 0 & 1 & 0 & 0 \\ 0 & 0 & 1 & 0 & 0 & 0 & 1 & 0 \\ 0 & 0 & 0 & 1 & 0 & 0 & 0 & 1 \end{bmatrix}$$

$$NZCC = [D \ C] = \begin{bmatrix} 1 & 0 & 0 & 0 & 1 & 0 & 0 & 0 & 1 & 0 & 0 & 0 \\ 0 & 1 & 0 & 0 & 0 & 1 & 0 & 0 & 0 & 1 & 0 & 0 \\ 0 & 0 & 1 & 0 & 0 & 0 & 1 & 0 & 0 & 0 & 1 & 0 \\ 0 & 0 & 0 & 1 & 0 & 0 & 0 & 1 & 0 & 0 & 0 & 1 \end{bmatrix}_{4 \times 12}$$

The NZCC code family is constructed based on the following conditions

- (a) N=K and W=1 for data segment (D)
- (b) N=K and W=1 for code segment (C)
- (c) N>K and W>1 for code segment (C)

Fig. 1 shows the flow chart step of the NZCC code family construction.

So the code word for each user would be:

$$\text{Code word} = \begin{cases} \text{user1} = \lambda_1, \lambda_5, \lambda_9 \\ \text{user2} = \lambda_2, \lambda_6, \lambda_{10} \\ \text{user3} = \lambda_3, \lambda_7, \lambda_{11} \\ \text{user4} = \lambda_4, \lambda_8, \lambda_{12} \end{cases}$$

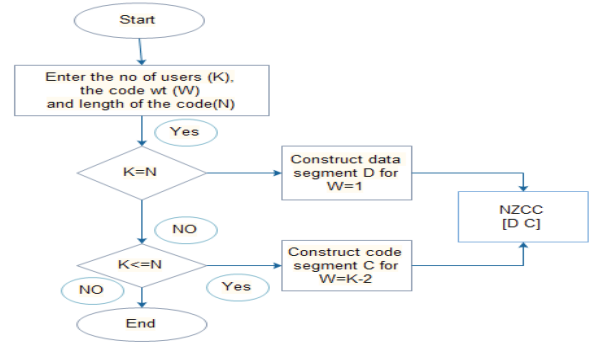

Fig. 1 Flow chart for NZCC code family construction

TABLE I
 COMPARISON OF DIFFERENT PROPERTIES OF PROPOSED NZCC AND OTHER CODES

Sl. No.	Code	No. of Users	Weight	Code Length
1	MD	60	2	60
2	RD	30	4	35
3	OOC	30	4	64
4	Prime code	30	31	961
5	EDW	30	3	60
6	MDW	30	4	90
7	NZCC	30	1	30
8	NZCC	30	2	60
9	NZCC	30	3	90

Table I shows the comparison between different codes and it can be clearly seen that the proposed NZCC presents advantages over other existing codes [10], [11], [13], [16], and [17]. As is observed from Table I, the code length of the proposed NZCC is the least among other codes for 30 numbers of users.

The NZCC code design represents those changing matrices elements resulting in a constant property of zero cross correlation resulting in cancellation of PIIN and MAI. The NZCC code provides more flexibility in choosing W and K parameters for its design to supply a large number of users compared to the other codes. The code length of the proposed NZCC code depends on the Weight (W) of the code, which is flexible. In Fig. 1, in the flow chart Code Weight (W) represents the code weight.

III. SYSTEM PERFORMANCE ANALYSIS

For the analysis of our system, Gaussian approximation is used for the calculation of BER as NZCC code exhibits zero cross correlation property and hence, there is no overlapping in the spectra of different users [20], [21] minimizing various types of noises. In this work, for the NZCC code, Thermal Noise (σ_t), PIIN (σ_{PIIN}) and Shot Noise (σ_{sh}) in the photo detector is considered. Since Square law photo detector is not used in this design OBN has negligible effect.

The performance of an optical receiver depends on the Signal to Noise Ratio (SNR). The SNR of an electrical signal is defined as the average Signal Power to Noise Power (SNR=

$\frac{I^2}{\sigma^2}$) where, σ^2 is defined as the variance of different noise sources. I is the Average Photo Current and I^2 is the Power of I . For NZCC coding

$$\sigma^2 = \sigma_{sh} + \sigma_i + \sigma_{PIIN} = 2eIB + \frac{4K_B T_n B}{R_L} + I_{PIIN}^2 B t_c \quad (2)$$

where e represents the electronic charge is the noise equivalent of the electrical bandwidth of the receiver, K_B is the Boltzmann's constant, T_n is the Absolute Receiver Temperature, R_L is the Receiver Load Resistance, B is the Electrical Bandwidth, t_c is the Coherent Time for light incident onto the photo diode and I_{PIIN} is PIIN photo noise current. $C_k(i)$ represents the i -th element of the k -th NZCC code sequence. According to the properties of NZCC code, the direct detection technique is expressed as:

$$\sum_{i=1}^N C_k(i) C_l(i) = \begin{cases} W(k=l) \\ 0(\text{otherwise}) \end{cases} \quad (3)$$

Since shot noise and thermal noise obey negative binomial distribution, the following assumptions are used to analyze the system with transmitter and receiver without much difficulty and for mathematical straightforwardness [22]-[25].

The assumptions are

- Each light source is ideally unpolarized and its spectrum is flat over the bandwidth $\left[v_0 - \frac{\Delta v}{2}, v_0 + \frac{\Delta v}{2} \right]$ where v_0 the central optical frequency is and Δv is the optical source bandwidth expressed in Hz.
- Each power spectral component has an identical spectral width.
- Each user has equal power at the transmitter.
- Each bit stream from each user is synchronized.

Using the above assumptions, the system performance is analyzed using Gaussian approximation. The Power Spectral Density (PSD) of the received optical signal is described as [26]:

$$r(v) = \frac{P_r}{\Delta v} \sum_{k=1}^k b_k \sum_{i=1}^N c_k(i) \text{rect}(i, v) \quad (4)$$

where, P_r is the Effective Power of a broadband source at the receiver, k is the No of Active Users, N is the NZCC code length, b_k is the Data Bit of the k -th user.

The $\text{rect}(i, v)$ function in (4) can be expressed as .

$$\begin{aligned} \text{rect}(i, v) &= u \left[v - v_0 - \frac{\Delta v}{2N} (-N + 2i - 2) \right] - u \left[v - v_0 - \frac{\Delta v}{2N} (-N + 2i) \right] \\ &= u \left[\frac{\Delta v}{N} \right] \end{aligned} \quad (5)$$

where $u(v)$ represents the Unit Step Function.

When a broadband pulse is source input to a group of Fiber Bragg gratings, the incoherent light fields are mixed and applied to the photo detector, and the phase noise of the fields appear in the photo detector output. The Coherence Time of the thermal source (t_c) is expressed as [27].

$$t_c = \frac{\int_0^\infty G^2(v) dv}{\left[\int_0^\infty G(v) dv \right]^2} \quad (6)$$

where, $G(v)$ is the Single Sideband Power Spectral Density (PSD) of the source.

From (6), the sum of Power Spectral Density at the photo detector of the i -th receiver during one period can be found by

$$\int_0^\infty G(v) dv = \int_0^\infty \left[\frac{P_r}{\Delta v} \sum_{k=1}^k b_k \sum_{i=1}^N c_k(i) c_l(i) \text{rect}(i, v) \right] dv \quad (7)$$

Substituting (4) in (5), we get (8) and it is expressed as:

$$\int_0^\infty G(v) dv = \frac{P_r}{\Delta v} \left[\sum_{k=1}^k b_k W \frac{\Delta v}{N} \right] \quad (8)$$

where, b_k is the Data Bit of the k -th user and that takes the value of either one or zero. When all users transmit bit '1', then

$$\left[\sum_{k=1}^k b_k \right] = [b_1 + b_2 + b_3 + \dots + b_k] = W \quad (9)$$

Therefore, (8) is simplified and written as:

$$\int_0^\infty G(v) dv = \frac{P_r W^2}{N} \quad (10)$$

The photo current 'I' is described as in (11):

$$I = \Re \int_0^\infty G(v) dv = \frac{\Re P_r W^2}{N} \quad (11)$$

where \Re is the Responsivity of the Photo Detector.

The Average Power of signal is represented as

$$I^2 = \left(\frac{\Re P_r W^2}{N} \right)^2 \quad (12)$$

PIIN Power for NZCC code for various weight parameters (W) can be expressed as [28]

$$I^2_{PIIN} = \frac{P_r W B R^2}{\Delta v} \quad (13)$$

Substituting (11) and (13) in (2), the Noise Power is found and is expressed as:

$$\sigma^2 = \frac{2eBP_r\mathcal{R}W^2}{N} + \frac{4K_B BT_n}{R_L} + \frac{P_r W B \mathcal{R}^2}{\Delta v} \quad (14)$$

Since the probability of sending bit '1' is 0.5, (14) becomes

$$\sigma^2 = \frac{eBP_r\mathcal{R}W^2}{N} + \frac{2K_B BT_n}{R_L} + \frac{P_r W B \mathcal{R}^2}{2\Delta v} \quad (15)$$

From (12) and (15), the average SNR is calculated as [28]:

$$SNR = \frac{I^2}{\sigma^2} = \frac{\left(\frac{\mathcal{R}P_r W^2}{N}\right)^2}{\frac{eBP_r\mathcal{R}W^2}{N} + \frac{2K_B BT_n}{R_L} + \frac{P_r W B \mathcal{R}^2}{2\Delta v}} \quad (16)$$

The Probability of Error (P_e) or the BER is estimated using Gaussian Approximation [28]:

$$P_e = BER = \frac{1}{2} \operatorname{erfc} \left(\sqrt{\frac{SNR}{8}} \right) \quad (17)$$

SNR represents the Signal to Noise Ratio and "erfc" is the Error Complimentary Function.

IV. THE SIMULATION SET UP AND OBSERVATION

The developed NZCC code is validated using an OCDMA trans-receiver circuit. The receiver in the circuit employs a direct detection receiving technique. This OCDMA trans-receiver circuit simulated using Opti-System v12.0 software.

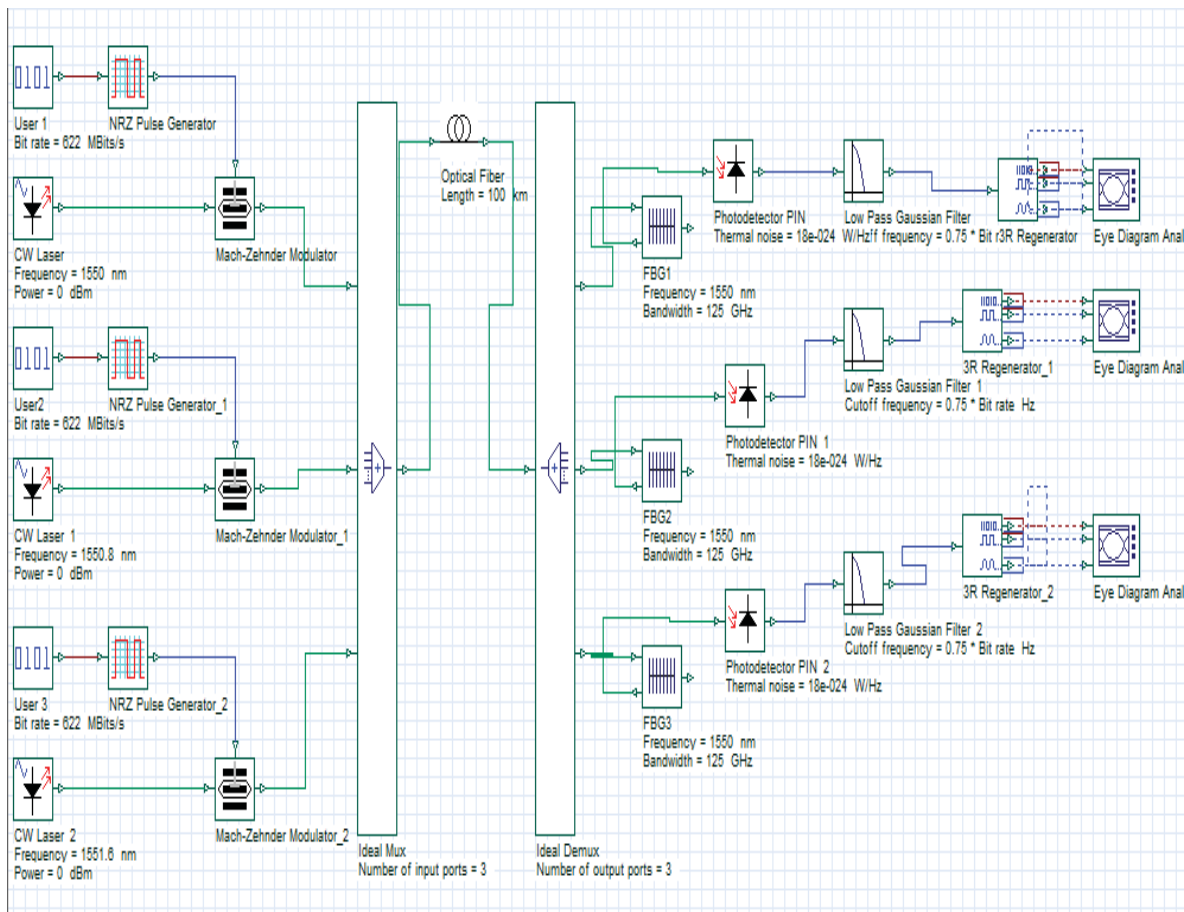

Fig. 2 Simulation circuit for 3 users [19]

As shown in Fig. 2, in the encoder side Continuous Wave (CW) lasers are used as optical source with the input power

varying from 0 dBm to -10 dBm, which produces pulses with a repetition rate equal to the bit rate of the system. The code

chips for different users are given as input through the user defined bit sequence generators and are encoded to the equivalent Non Return to Zero (NRZ) signals. A Mach-Zehnder modulator modulates the signals/data. The modulated signals are multiplexed in a WDM multiplexer and then are transmitted in a single mode optical fiber with the natural channel parameters [29]. In the receiver side, first a demultiplexer is used to transmit the data to three different receivers. For each receiver, a uniform Fiber Bragg Grating (FBG) is used to filter the received signal corresponding to the transmitted wavelength at the source. A PIN photo diode detector is used to convert optical data to electrical signal which is then transmitted through a low pass Gaussian filter and corresponding regenerator [30]. A Visualizer (Eye Diagram Analyzer) is connected at the end to analyze the received signal.

The performance of NZCC code has been compared mathematically with various recent codes such as RD code [31], MQC code, Walsh code, FFH code, EDW code, OOC code, MS code, Prime codes using (16). The parameters used in our analysis are listed in Table II.

TABLE II
SYSTEM PARAMETERS USED IN THE SIMULATION

Sl. No.	Parameters	Quantity
1	Line encoding	NRZ
2	Effective Power at the source	0 to -10 dBm
3	Number of users	20 to 120
4	Operating Wavelength	1550 nm
5	Fiber length	10 to 50 km
6	Data rate	622 Mbps to 1 Gbps
7	Received power	0 to -35 dBm
8	Fiber attenuation	0.2 dB/km
9	Dispersion	16.75 ps/nm/km
10	PMD coefficient	0.5 ps/sqrt(km)

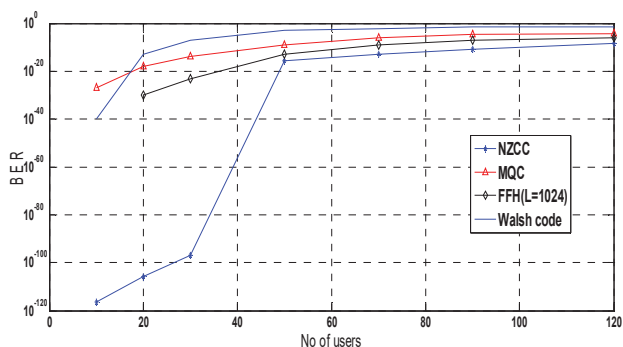

Fig. 3 BER vs. No of users for various codes at 1 Gbps data rate in SAC-OCDMA technique

Fig. 3 shows the relationship between the no of simultaneous users versus the BER for NZCC, MQC, FFH and Walsh codes for different value. Fig. 3 shows that the performance of NZCC code is better compared to other codes [32]. The maximum acceptable BER of 10^{-15} is achieved by NZCC code which is much less than other codes for data rate of 1 Giga Bits per Second (Gbps). Also for lesser no of users

the acceptable BER is much lesser (as low as 10^{-80}) than other codes.

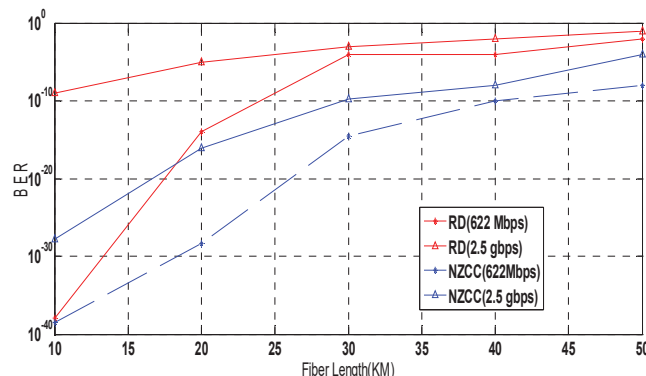

Fig. 4 BER vs Fiber length for various codes employing different data rates in SAC-OCDMA technique

Fig. 4 compares BER vs Fiber length for two different codes employing different data rates in SAC-OCDMA technique. Here the NZCC code performance is much better for different data rates in comparison to Random diagonal (RD) code because of lower BER level.

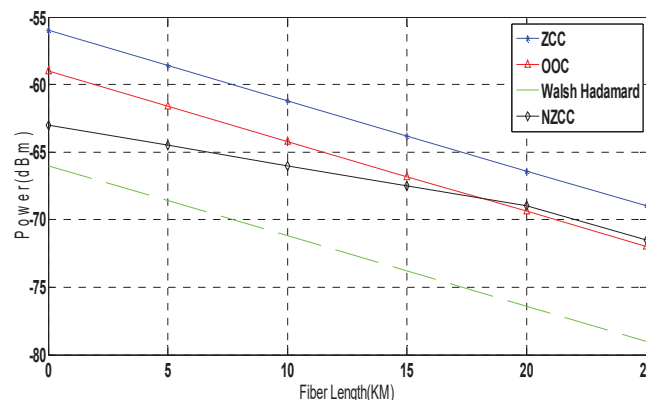

Fig. 5 Received Power (dBm) vs Fiber length for various codes in SAC-OCDMA technique

Fig. 5 depicts the variation of received power with respect to fiber length. It can be seen that variation in received power for NZCC code with respect to length of the fiber is much lesser than other codes like ZCC, OOC, and Walsh-Hadamard code implying better system performance of NZCC code.

Fig. 6 shows that code length for NZCC code for weight=1 or 2, is much lesser in comparison to other codes like Prime code, OOC code and MS code [33], resulting in less complexity in designing encoders and decoders improving the overall system performance.

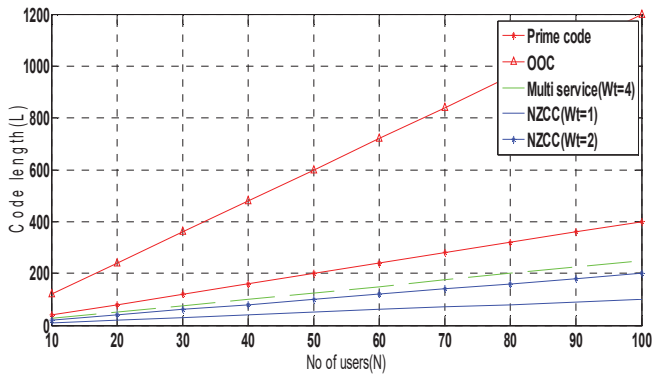

Fig. 6 Code length (L) vs. No of users (N) for various OCDMA codes

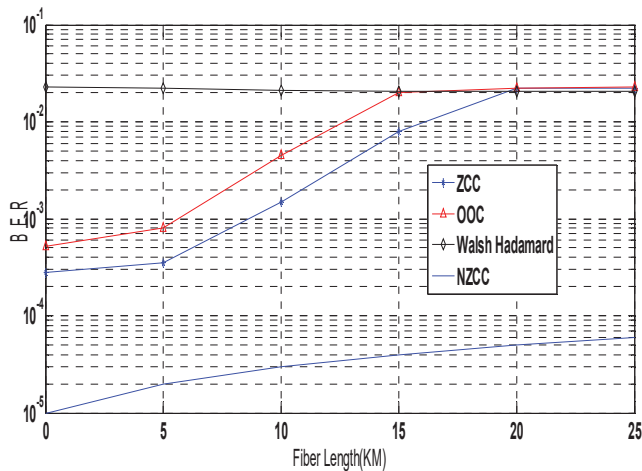

Fig. 7 BER vs Fiber length for various codes employing SAC-OCDMA technique

BER for NZCC code for a given fiber length for 50 users at data rate of 10 Giga bits per second is much lesser than other codes like ZCC code, OOC code and Walsh-Hadamard code as shown in Fig. 7. Because of much lesser BER the overall performance of an OCDMA system employing NZCC code improves a lot at various conditions.

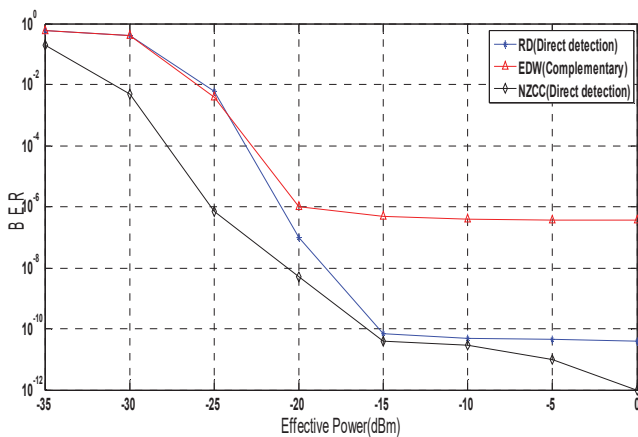

Fig. 8 BER vs. Effective Power (dBm) for various codes employing different detection techniques in SAC-OCDMA technique

Fig. 8 shows that BER for a OCDMA system for a given effective power is much lesser in case of NZCC code with direct detection technique in comparison to other techniques like RD with direct detection and EDW with complementary detection [34] improving the overall system performance.

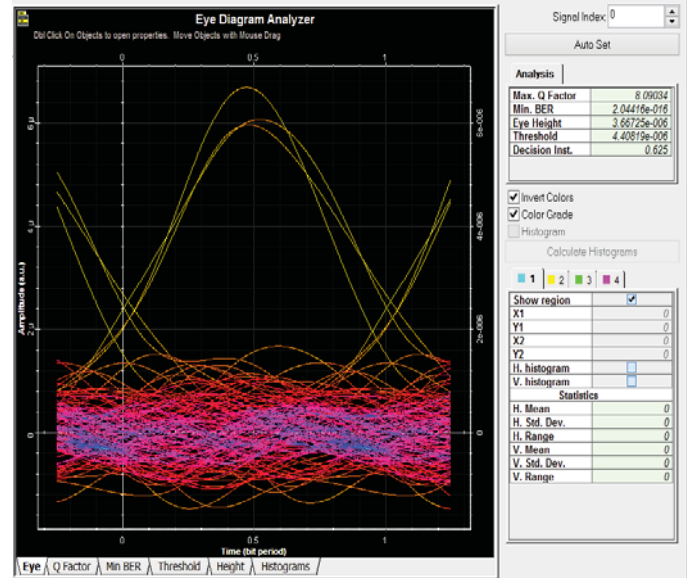

Fig. 9 Eye diagram indicating performance of 50 user, -10 dBm power, 50 km length for NZCC code

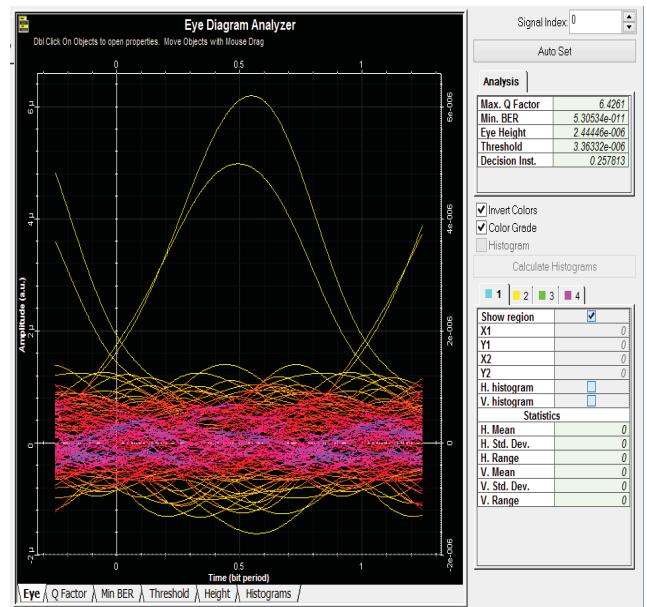

Fig. 10 Eye diagram indicating performance of 90 user, 10 gbps, 50 km length and power input -10 dBm for NZCC code

The performance of any OCDMA system can be characterized by referring to the BER and eye pattern. The eye pattern of NZCC code system as shown in Figs. 9 and 10 clearly show that the NZCC code system provides a better BER in the range of 10^{-16} and 10^{-11} as the no of users were increased. The more the eye closes, the more difficult it is to

differentiate between ones and zeros in the signals. The height of the eye opening at certain sampling time shows the noise margin or immunity to noise.

V. CONCLUSION

A code family with zero cross-correlation for SAC-OCDMA systems is successfully designed, and simulated. The code family, which called NZCC code, shows better system performance as compared to the former SAC-OCDMA codes with the same system complexity. The NZCC code offers several advantages such as zero cross-correlation, minimum BER, more flexibility, and simple code construction as compared to that of other existing SAC-OCDMA codes. Also, the code features better flexibility in choosing the code parameter (e.g., number of users, distance of the fiber, the code weight and cross correlation) and the number of users can be increased without any increase in the code weight and code complexity. In the absence of MAI and PIIN, the system shows excellent performance with spectral amplitude coded asynchronous optical CDMA. Unlike the other existing SAC-OCDMA codes, in the proposed NZCC code, the code length does not increase much with the increase in the number of users, no overlapping of spectra for different users. Finally, simplicity in the code construction, flexibility in cross-correlation control and minimum BER during transmission has made this code suitable for future OCDMA applications.

ACKNOWLEDGMENT

The authors would like to extend their sincere appreciation to the All India Council of Technical Education (AICTE) for the funding of this research through the research project number 20/AICTE/RIFD/RPS (POLICY-II) 2/2012-13.

REFERENCES

- [1] Chen Biao, Wang Fu-chang, Hu Jian-dong and He Sai-ling., "A novel OCDMA drop unit based on fiber gratings and 2D wavelength-time codes", *Optoelectronics Letters*. vol. 1, 2005, pp. 53–56.
- [2] Hongxi Yin, Wei Liang, Le Ma and Liqiao Qin., "A new family of two-dimensional triple code weight asymmetric optical orthogonal code for OCDMA networks", *Chinese Optoelectronics Letters*. vol. 7, 2009, pp. 102–105.
- [3] Zouine Y, Dayoub I, Haxha S and Rouvaen J. M., "Analyses of constraints on high speed optical code division multiplexing access (OCDMA) link parameters due to fiber optic chromatic dispersion", *Journal of Optical Communication*. vol. 281, 2008, pp. 1030–1036.
- [4] Santoro M A and Fan T R., "Spread spectrum fiber optic local area network using optical processing", *Journal of Light wave Technology*. vol. 4, 1986, pp.547–554.
- [5] Pfeiffer T, Deppisch B, Witte M and Heidemann R., "Operational stability of a spectrally encoded optical CDMA system using inexpensive transmitters without spectral control", *IEEE Photonic Technology Letters*, vol. 11, 1999, pp. 916–918.
- [6] Pfeiffer T, Schmuck H, Deppisch B, Witte M and Kissing J., "TDM/CDM/WDM approach for metro networks with 200 optical channels", *proceeding at 26th ECOC (Munich, Germany)*. vol. 3, 2000, pp 77–78.
- [7] Hernandez V. J, Mandez A J, Bennett C.V, Gagliardi R. M, and Lennon W.J., "Bit error rate analysis of a sixteen-user gigabit Ethernet optical CDMA (OCDMA) technology demonstrator using wavelength/time codes", *IEEE Photonic Technology Letters*. vol. 17, 2005, pp 2784–2786.
- [8] Stok A, and Sargent E.H., "Lighting the local network: Optical code division multiple access and quality of service provisioning", *IEEE*

- Networks*, vol. 14, 2000, pp. 42–46.
- [9] Mohammed Noshad, and Kambiz Jamshidi., "Code family for modified spectral amplitude coding OCDMA system and performance analysis", *Journal of Optical Communication Networks*. vol. 2, 2010, pp. 344–354.
- [10] Hasson F N, Aljunid S A, Samad M.D.A and Abdullah M K., "Spectral amplitude coding OCDMA using AND subtraction technique", *Application of Optics*. vol. 47, 2008, pp. 1263–1268
- [11] Wei Z.H, Shalaby M, and Shiraz H.G., "New code families for fiber-Bragg-grating-based spectral-amplitude-coding optical CDMA systems", *IEEE Photonic Technology Letters*, vol.13, 2001, pp. 890–892
- [12] Wei Z, Shalaby H.M.H, and Ghafouri Shiraz H., "Modified quadratic congruence codes for fiber Bragg-grating based spectral-amplitude coding optical CDMA system", *Journal of Lightwave Technology*, vol. 19, 2001, pp.1274–1281.
- [13] Salehi J.A., "Code division multiple access technique in optical fiber networks. Part II: System performance analysis", *IEEE Transaction on Communication*, vol. 37, 1989, pp. 834–842.
- [14] Yang G.C and Kwong W.C., "Prime code with applications to CDMA optical and wireless networks", *Boston: Artech House*, 2002.
- [15] Ahmad Anas S.B, Abdullah M.K, Mokhtar M., Aljunid S.A and Walker S.D., "Optical domain service differentiation using spectral-amplitude-coding", *Journal of Optical Fiber Technology*. Vol. 15, 2009, pp. 26–32.
- [16] Hillal Adnan Fadhil, Aljunid S.A, and Ahmed R.B., "Effect of random diagonal code link of an OCDMA scheme for high-speed access networks", *Journal of Optical Fiber Technology*, vol. 15, 2009, pp. 237–241.
- [17] Aljunaid S.A, Ismail M, and Ramil A.R., "A new family of optical code sequence for spectral-amplitude-coding optical CDMA systems", *IEEE Photonic Technology Letters*, vol. 16, 2004, pp. 2383–2385.
- [18] Abd T, Aljunaid S, Fadhil H., "A new technique for reduction of the phase induced intensity noise in SAC-OCDMA system", *Journal of Optical Communication*, vol. 5, 2011, pp.138–44.
- [19] T.H. Abd, S.A. Aljunaid, H.A. Fadhil, R.A. Ahmad, N.M. Saad, "Development of a new code family based on SAC-OCDMA system with large cardinality for ocdma networks". *Journal of optical fiber technology*, vol. 17, 2011, pp. 273–280.
- [20] S.A Aljunaid, M. Ismail, A.R Ramil. "A new family of optical code sequence for spectral amplitude coding optical CDMA systems", *IEEE photon. Technology letter*, vol.16, 2004, pp.2383-2385.
- [21] Zou Wei, H.M.H Shalaby, H Ghafouri-shiraz, "Modified quadratic congruence code for fiber Bragg Grating based spectral amplitude coding optical cdma system". *Journal of light wave technology*. vol 19, 2001, pp.1274-1281.
- [22] E.D.J. Smith, R.J. Blakie, D.P. Taylor, "Performance enhancement of spectral amplitude coding optical cdma using pulse position modulation", *IEEE transaction on communication*, vol.46, 1998, pp.1176-1184.
- [23] M.S Anwar, S.A. Aljunaid, N.M. Saad, S.M. Hamzah, "New design of spectral amplitude coding in ocdma with zero cross correlation", *Journal of optical communication*, vol.282, 2009, pp.2659-2664.
- [24] Z. Wei, H. Ghafouri-Shiraz, "Unipolar codes with ideal in phase cross correlation for spectral amplitude coding optical cdma system", *IEEE transactions on communication*, vol.50, 2002, pp.1209-1212.
- [25] J.H. Wen, J.S. Zhou, C.P.Li, "optical spectral amplitude coding cdma systems using perfect difference code and interference estimation", *IEEE proceedings Optoelectronics*, vol.153, 2006, pp.152-160.
- [26] C.C. Yang, J.F. Huang, S.P.Tseng, "optical cdma network codes structured with M-sequence codes over waveguide-grating routers", *IEEE photonic transaction letters*, vol. 16,2004, pp. 641-643.
- [27] I. B. Djordjevic, B. Vasic, "Combinational constructions of optical orthogonal codes for ocdma systems", *IEEE communication letters*, vol. 8(6),2004.
- [28] H.A. Fadhil, S.A. Aljunaid, H.Y. Ahmed, H.M.R. Alkhafaji, "Variable cross-correlation code construction for spectral amplitude coding optical CDMA networks". *Journal of Optik*, vol.123, 2012, pp.956-963.
- [29] Vishal Jyoti, R.S. Kaler, "Design and performance analysis of various one dimensional codes using different data formats for OCDMA system", *Journal of Optik*, vol.122, 2011, pp.843-850.
- [30] Gerd Keiser. "Optical Fiber Communication (Third edition), New York": *Mc Grawhill* (1986).
- [31] Hillal Fadhil, Aljunid S, and Ahmed B., "Performance of OCDMA system using Random diagonal code for different decoders architecture schemes", *International Arab Journal of Information Technology*, vol.

- 7, no.1, 2010, pp. 1–5.
- [32] Shin –pin Tseng “Fast frequency hopping codes applied to SAC optical CDMA network”, *Journal of optical fiber technology*, vol. 23, 2015, pp.61-65.
- [33] M H Kakaee, Saleh S,H A Fadhil, S B A Anas, M Mokhtar. “Development of Multi-Service (MS) for SAC-OCDMA system”. *Journal of Optic & Laser technology*.vol.60, 2014, pp.49-55.
- [34] H A Fadhil, S A Aljunaid, R B Ahmad. “Design consideration of high performance OCDMA: A new spectral amplitude code based on laser and light emitting diode light source”. *Journal of IET optoelectronics*, vol. 10, 2009.