

Simulation Study on Vehicle Drag Reduction by Surface Dimples

S. F. Wong, S. S. Dol

Abstract—Automotive designers have been trying to use dimples to reduce drag in vehicles. In this work, a car model has been applied with dimple surface with a parameter called dimple ratio DR , the ratio between the depths of the half dimple over the print diameter of the dimple, has been introduced and numerically simulated via $k-\epsilon$ turbulence model to study the aerodynamics performance with the increasing depth of the dimples. The Ahmed body car model with 25 degree slant angle is simulated with the DR of 0.05, 0.2, 0.3, 0.4 and 0.5 at Reynolds number of 176387 based on the frontal area of the car model. The geometry of dimple changes the kinematics and dynamics of flow. Complex interaction between the turbulent fluctuating flow and the mean flow escalates the turbulence quantities. The maximum level of turbulent kinetic energy occurs at $DR = 0.4$. It can be concluded that the dimples have generated extra turbulence energy at the surface and as a result, the application of dimples manages to reduce the drag coefficient of the car model compared to the model with smooth surface.

Keywords—Aerodynamics, Boundary Layer, Dimple, Drag, Kinetic Energy, Turbulence.

I. INTRODUCTION

A. Problem Statement

As of today, the study on the effect of dimples focusses on bluff body application (i.e. golf ball) than streamlined body application (i.e. car surface). Several previous studies (experimental and numerical) however observed that dimples on an airfoil create extra turbulence to delay the boundary layer separation. For example, [1] has suggested a smart dimple matrix over the airfoil which will sense boundary layer separation and arrange dimple in the least drag and high lift configuration which is shown in Fig. 1. Moreover, composite shaped and outward dimples have the least drag when compared to the round and inward dimples. It was found that the dimples will reduce the velocity in the boundary layer and also reduce the surface vorticity. Besides that, dimples will also make the momentum layer inside the boundary become thinner leading to drag reduction [2], [3].

German researchers proved an effect which could revolutionize the design of ships, vehicles and aircrafts. They came to an unexpected result: the train with dimples has 16% less frictional resistance, depending on the speed. The finding seems contradicting the theorem that says surface roughness (dimple) increases the surface area thus friction. Moreover, the drag reduction was overcome by the newly appearing pressure force contribution due to surface unevenness. The pressure

validation involved a Scanivalve unit and a Validyne differential pressure gauge. Fig. 2 shows a typical example for each test of Reynolds number $Re \frac{1}{4} U_b d = m$ (bulk velocity U_b , channel half-width d) the pressure gradient $dp = dx$ was deduced by a linear fit of the measured pressure data [4]. Therefore, adding a dimple on a streamlines body might help to delay the flow separation and reduce the size of the wake but it might increase the friction drag as a trade-off. The present work aims to provide the answer with physics clarifications.



Fig. 1 Multi dimpled configuration

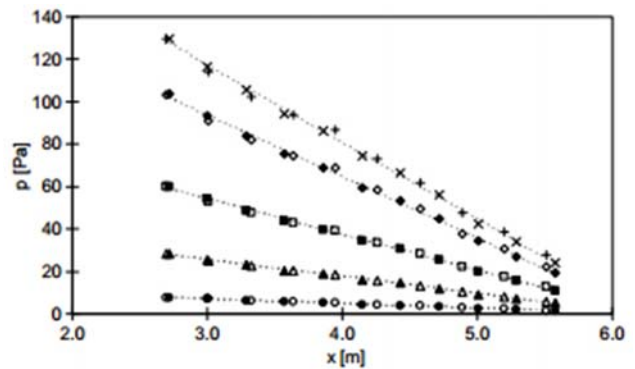

Fig. 2 Pressure distribution measured along flat and dimpled side of the channel for various Reynolds numbers

S. F. Wong and S. S. Dol are with the Department of Petroleum Engineering, Curtin University, Miri, Sarawak, Malaysia (e-mail: wong.siew.fan@postgrad.curtin.edu.my, sharulsham@curtin.edu.my).

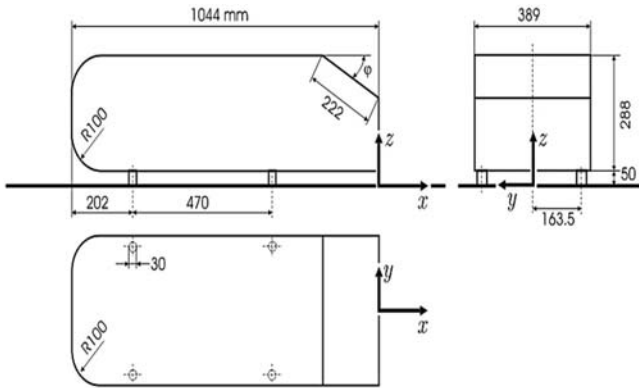

Fig. 3 Dimension details of the Ahmed body car model

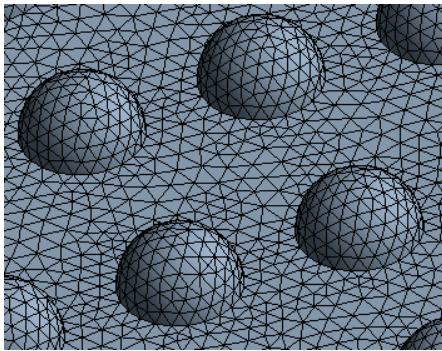

Fig. 4 Tetrahedral mesh around dimples

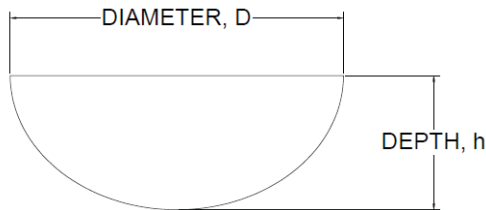

Fig. 5 Dimple ratio

TABLE I
 QUALITY OF MESH FOR ALL MODELS

Model	Nodes	Elements	Skewness	Orthogonal Quality
Smooth surface	142564	782743	0.222	0.862
DR = 0.05	319366	1798765	0.221	0.863
DR = 0.2	282862	1578882	0.221	0.863
DR = 0.3	283411	1580105	0.221	0.863
DR = 0.4	284911	1586428	0.221	0.863
DR = 0.5	280090	1560387	0.221	0.863

TABLE II
 BOUNDARY CONDITION

Boundary	Conditions
Ahmed Body	Stationary Wall
Sides	Symmetry
Top	Symmetry
Center	Symmetry
Road	Stationary Wall
Inlet	Velocity Inlet
Outlet	Pressure Outlet

II. APPROACH AND METHODS

In this work, Ahmed body car model with 25-degree slant angle will be used. Ahmed body car model is a simplify car model for accurate flow simulation but still retain with the significant features of a car which are curved fore body, straight center section and the angled rear end. As shown in Fig. 3, it is a typical bluff body which commonly using for the simulation to study the flow past a car [5].

For the computational fluid dynamics (CFD) simulation, the tetrahedral meshing is applied (Fig. 4) and k-ε model in ANSYS Fluent has been chosen for turbulence modeling. k-ε model consists of two transport equations to represent the turbulent properties of the flow. The first transport variable is the kinetic energy term, k. It is the variable to determine the turbulent energy production.

$$\frac{\partial}{\partial t}(\rho k) + \frac{\partial}{\partial x_i}(\rho k u_j) = \frac{\partial}{\partial x_j}[(\mu + \mu_t/\sigma_k) \cdot \frac{\partial}{\partial x_j}] + G_k + G_b - \rho \varepsilon - Y_M + S_k \quad (1)$$

The second transport variable is the turbulent dissipation term, ε. It is the variable to determine the scales of the turbulence.

$$\frac{\partial}{\partial t}(\rho \varepsilon) + \frac{\partial}{\partial x_i}(\rho \varepsilon u_j) = \frac{\partial}{\partial x_j}[(\mu + \mu_t/\sigma_\varepsilon) \frac{\partial \varepsilon}{\partial x_j}] + \rho C_1 S_\varepsilon - \rho C_2 [\varepsilon^2 / (k + \sqrt{\nu \varepsilon})] + C_{1\varepsilon} \cdot \varepsilon / k \cdot C_{3\varepsilon} \cdot G_b + S_\varepsilon \quad (2)$$

G_k is the generation of turbulence kinetic energy due to the mean velocity gradients. G_b is the generation of turbulence kinetic energy due to buoyancy. Y_M is the contribution of the fluctuating dilatation in compressible turbulence to the overall dissipation rate. $C_{1\varepsilon}$ and C_2 , and σ_k and σ_ε are constants and turbulent Prandtl numbers for k and ε respectively. S_k and S_ε are user defined source terms. Further info can be referred in [6].

A parameter called dimple ratio (DR) has been introduced. Basically, dimple ratio is the ratio between the depths of the half dimple over the print diameter of the dimple. In this work, car model with be simulated with the DR of 0.05, 0.2, 0.3 0.4 and 0.5 at Reynolds number of 176387 based on the frontal area of the car model.

$$\text{Dimpleratio, DR} = \text{depth, } h / \text{diameter, } D \quad (3)$$

The meshing is done by using ANSYS meshing software. Tetrahedral meshing is used for the analysis. Table I shows the setting that has been applied to all models. It shows that the skewness and the orthogonal quality of the meshing are within the acceptable region of simulation accuracy.

In this work, the air velocity was set as 40m/s at the inlet. The other boundary conditions are presented in Table II.

The following equation has been used to calculate the Reynolds number of the flow in order to determine the flow past the model either is laminar or turbulent.

$$Re = \frac{\rho U A}{\mu} = \frac{1.2 \times 40 \times 0.065741}{1.789 \times 10^{-5}} = 176387$$

where: ρ is the density of air; U is the flow velocity; A is the frontal area of the car model; μ is the dynamic viscosity of air.

The value obtained for the Reynolds number corresponds to a turbulent air flow.

III. RESULT AND DISCUSSION

From Figs. 6-9, two main changes can be observed. First, pressure is reduced at the end of the roof which is the edge for all the models that have dimples. When compared with the model without dimple (Fig. 6), dimpled models have lower pressure at the edge. This is due to the accelerating velocity at the vicinity (e.g. Fig. 9 (e)).

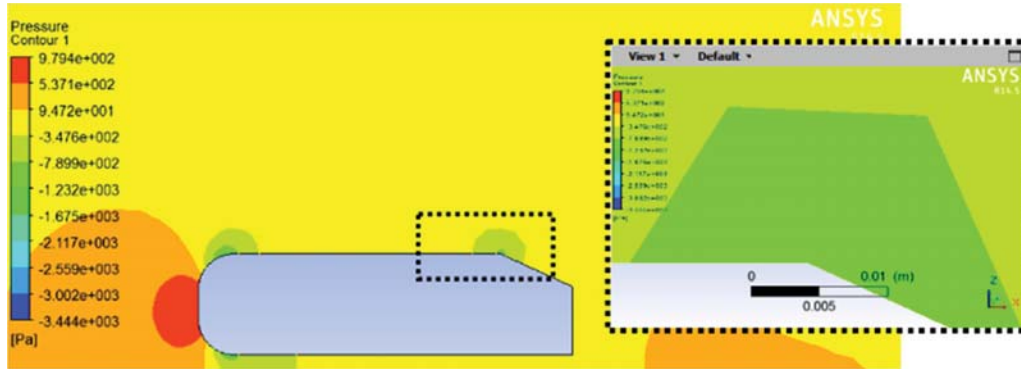
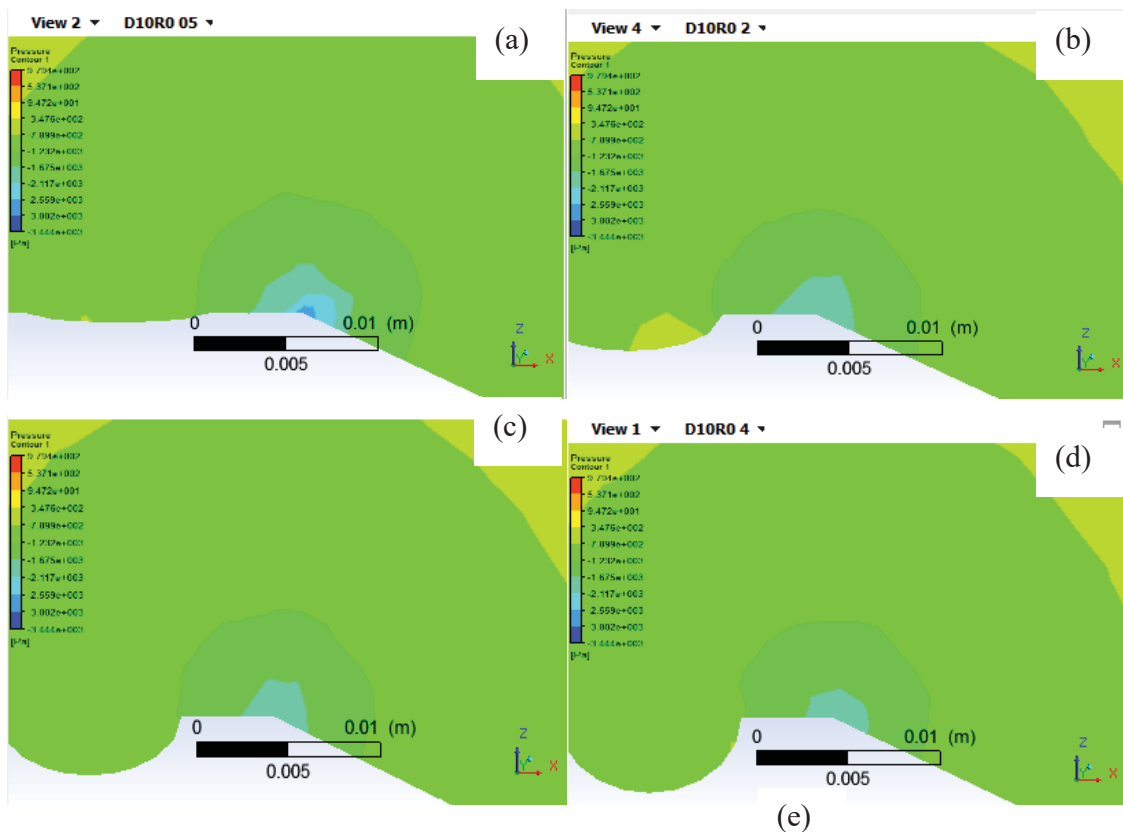

Fig. 6 Pressure contour for model with smooth surface



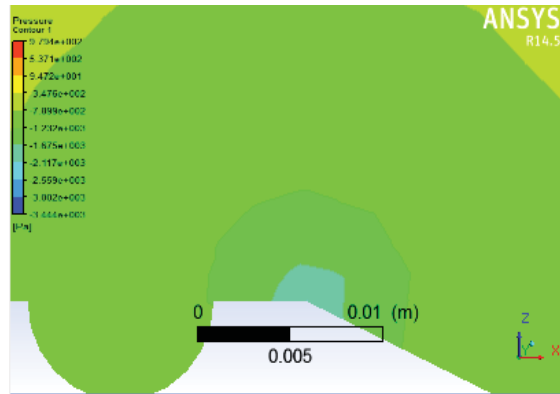

Fig. 7 Pressure contour (a) DR = 0.05; (b) DR = 0.2; (c) DR = 0.3; (d) DR = 0.4; (e) DR = 0.5

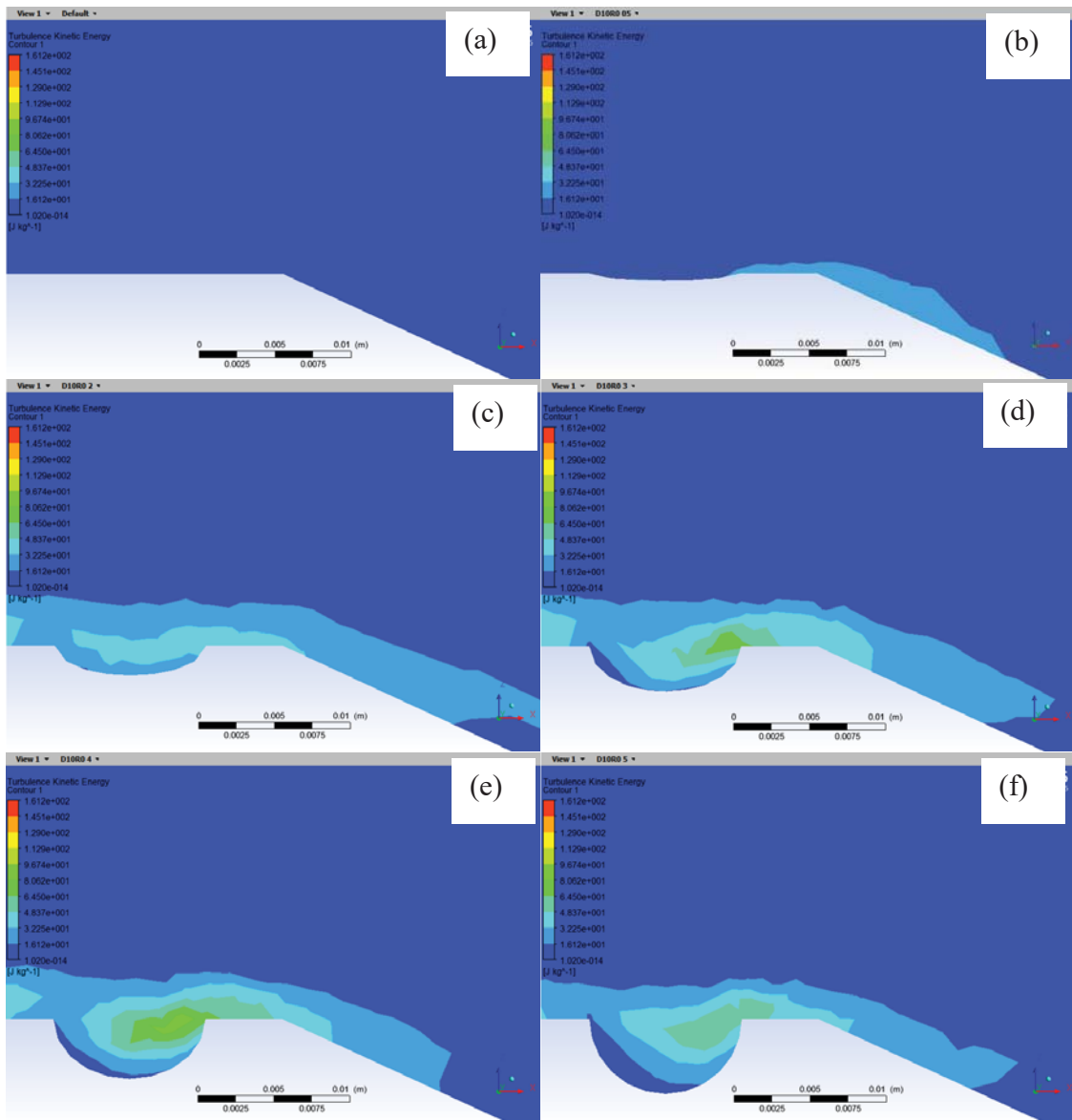

Fig. 8 Turbulence kinetic energy contour (a) DR = 0; (b) DR = 0.05; (c) DR = 0.2; (d) DR = 0.3; (e) DR = 0.4; (f) DR = 0.5

When compared with the model without dimple (Fig. 8 (a)), turbulent kinetic energy is generated within the dimple and at the vicinity of the dimple edge (Figs. 8 (b)-(f)). These results

suggest that the boundary layer flows manage to go further before the flow separation takes place.

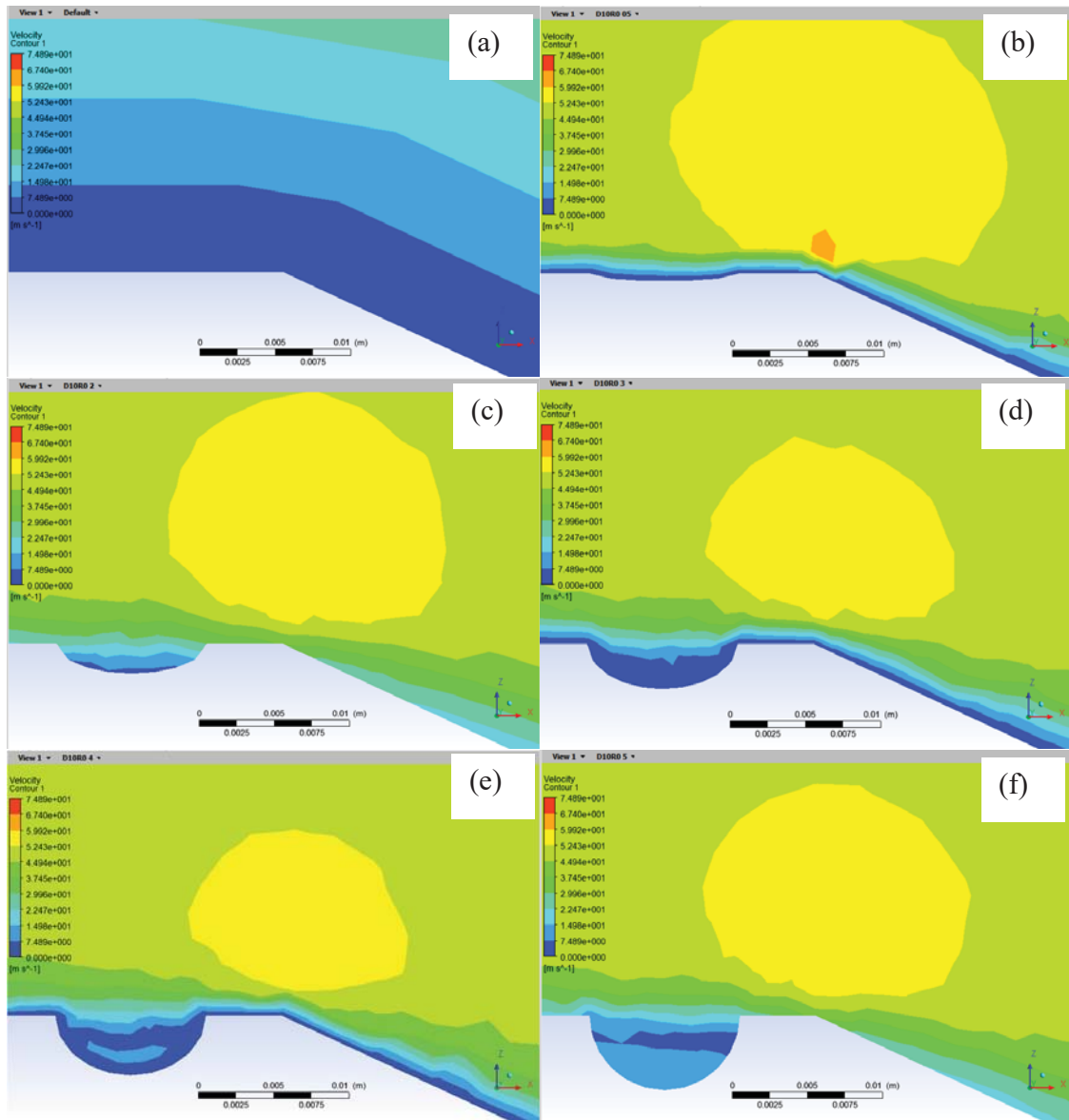

Fig. 9 Velocity contour (a) DR = 0; (b) DR = 0.05; (c) DR = 0.2; (d) DR = 0.3; (e) DR = 0.4; (f) DR = 0.5

The geometry of dimple changes the kinematics and dynamics of flow. Complex interaction between the turbulent fluctuating flow and the mean flow escalates the turbulence quantities and the boundary layer gains momentum from this turbulent kinetic production. The maximum level of turbulent kinetic energy occurs at DR = 0.4 as shown in Fig. 8 (e). From these changes, it can be concluded that the dimples have generated extra turbulence energy at the surface. With the extra energy, the flow manages to go further before the flow separation take place.

TABLE III
 COMPARISON OF DRAG COEFFICIENT

Model	Drag Coefficient	Percentage Difference (%)
Smooth surface	0.261	-
DR = 0.05	0.257	1.32
DR = 0.2	0.259	0.55
DR = 0.3	0.260	0.07
DR = 0.4	0.255	1.95
DR = 0.5	0.258	0.84

One of the aims of this work is to determine how much changes the dimples will bring to the coefficient of drag. All the dimple ratio models give smaller coefficient of drag, C_D

compared to the model without dimple (Table III). The coefficient of drag, C_D is reduced by 1.95% for the model with $DR = 0.4$.

IV. CONCLUSION

Application of dimple on the car surface has proven to be effective. The dimples manage to reduce the drag coefficient. The results are encouraging since the simulation is only based on one dimple. Different parameters like dimples position, number of dimples, dimples orientation will be tested in order to fully understand the performance of the dimple application on vehicle aerodynamics.

REFERENCES

- [1] D. Srivastav, Flow control over airfoils using different shaped dimples, *International Conference on Fluid Dynamics and Thermodynamics Technologies*, (2012) 92–97, Singapore: IACSIT Press.
- [2] L.-m Tian, L.-q Ren, Q.-p Liu, Z.-w Han, X, Jiang, The mechanism of drag reduction around bodies of revolution using bionic non-smooth surfaces, *Journal of Bionic Engineering*, (2007) 109-116.
- [3] Dol, S.S., Azimov, U. & Martinuzzi, R.J.M. (2012). Statistical description in the turbulent near wake of rotating circular cylinder. *World Academy of Science, Engineering and Technology* 72, 505 – 509.
- [4] L. Hermann, B. Michael, K. Cagatay, Drag Reduction by dimples? A Complementary Experimental/Numerical Investigation, *International Journal of Heat and Fluid Flow*, 29(3), (2008) 783-791.
- [5] S.R. Ahmed, G. Ramm, G. Faltn, Some salient features of the time-averaged ground vehicle wake, *SAE Society of Automotive Eng., Inc*, 1(840300) (1984) 1–31.
- [6] C.K. Chear, S.S. Dol, Vehicle Aerodynamics: Drag Reduction by Surface Dimples? *International Journal of Mechanical, Aerospace, Industrial and Mechatronics Engineering* 9(1) (2015), 202-205.