

# Speed Control of Permanent Magnet Synchronous Motor Using Evolutionary Fuzzy PID Controller

M. Umabharathi, S. Vijayabaskar

**Abstract**—Evolutionary Fuzzy PID Speed Controller for Permanent Magnet Synchronous Motor (PMSM) is developed to achieve the Speed control of PMSM in Closed Loop operation and to deal with the existence of transients. Consider a Fuzzy PID control design problem, based on common control Engineering Knowledge. If the transient error is big, that Good transient performance can be obtained by increasing the P and I gains and decreasing the D gains. To autotune the control parameters of the Fuzzy PID controller, the Evolutionary Algorithms (EA) are developed. EA based Fuzzy PID controller provides better speed control and guarantees the closed loop stability. The Evolutionary Fuzzy PID controller can be implemented in real time Applications without any concern about instabilities that leads to system failure or damage.

**Keywords**—Evolutionary Algorithm (EA), Fuzzy system, Genetic Algorithm (GA), Membership, Permanent Magnet Synchronous Motor (PMSM).

## I. INTRODUCTION

IN recent years, the Permanent Magnet Synchronous motor (PMSM) has emerged as an alternative to Induction Motor due to the increasing energy saving demand. PMSM are widely used in high performance applications such as industrial robots and machine tools because of its compact size, high power density, high airgap flux density, high torque/inertia ratio, high torque capability, high efficiency and free maintenance. Many researchers have proposed a great deal of advanced PMSM control methods, e.g., model predictive control [1], [2], switching control [3], internal model control [4], adaptive back stepping control [5], fuzzy speed regulator method [6], adaptive control [7]-[9], fuzzy PI current control [10], adaptive fuzzy controller [11], [12], nonlinear optimal control [13], neuro adaptive control [14], sliding mode control [14], novel fuzzy control [15].

The Advancements in magnetic materials, semiconductor power devices and control theories have made the PMSM drives play a vitally important role in motion control applications. The rotor of PMSM is connected to the load that cause low pulsation torque quality. Overlapping control during phase transition may also trim down the torque pulsation. For this PMSM required the power inverter to operate at higher switching frequency. So that it attains overlap control and noise reduction. In order to achieve the desired performances of PMSM as the behaviour of DC motors, direct control of

stator currents is needed. Otherwise, it is quite unattainable due to the strong coupling and nonlinear natures of the AC motors. Hence, to realize the decoupling of relevant variables, a particular algorithm must be introduced. This problem has been resolved by the vector control technology, often referred to as Field Oriented Control (FOC).

A conventional synchronous motor is generally implemented with sliprings and a field winding. Synchronous motors are generally preferred whereas constant speed is desired under varying loads. Their speed can be adjusted by using inverters or adjustable voltage or frequency source. Speed control is the key factor in the PMSM motor for industrial applications. It is achieved by the Evolutionary Fuzzy PID Speed controller. Recently, Fuzzy logic controllers (FLCs) have generated a good deal of interest in certain applications. The advantage of FLCs over conventional controllers are that they do not need an accurate mathematical model, they can work with imprecise inputs, can handle linearity, and they are more robust than conventional nonlinear controllers. Evolutionary Fuzzy systems are hybrid Fuzzy systems where evolutionary optimization algorithms are used to optimize/adapt Fuzzy expert knowledge.

The evolutionary optimization algorithms operate by representing the optimization parameters via a gene like structure and subsequently utilizing the basic mechanisms of Darwinian natural selection to find a population of superior parameters. There are various approaches to evolutionary optimization algorithms including evolution strategies, evolutionary programming, genetic programming and genetic algorithms. These various algorithms are similar in their basic concepts of evolution and differ mainly in their approach to parameter representation. Genetic algorithms (GA), in particular, is an evolutionary method which has demonstrated to perform well in noisy, nonlinear and uncertain optimization landscapes typical of Fuzzy systems. PID control is a feedback mechanism which is used in control system. This type of control is also termed as three term control. By controlling the three parameters - proportional, integral and derivative we can achieve different control actions for specific work. PID is considered to be the best controller in the control system. In PID controller, two parameters can work while keeping the third one to zero. So PID Controller becomes sometimes PI (Proportional Integral), PD (Proportional Derivative) or even P or I. The derivative term D is responsible for noise measurement while integral term is meant for reaching the targeted value of the system.

In early days, PID Controller was used as mechanical device. In modern days PID Controllers are used in PLC

M. Umabharathi is with the P.A College of Engineering and Technology, Coimbatore, India (Phone: 9578650257; e-mail: bharathi9865@gmail.com).

Dr. S. Vijayabaskar, Associate Professor, is with the P.A College of Engineering and Technology, Coimbatore, India (Phone: 9842780064; e-mail: svbkec@gmail.com).

(Programmable Logic Controllers) in the industry. The proportional, integral, derivative parameters can be expressed as  $K_p$ ,  $K_i$ ,  $K_d$ . All these parameters have effect on the closed loop control system. It affects the rise time, settling time, overshoot and steady state error. Proportional plus integral (PI) controllers are usually preferred, but due to its fixed proportional gain and integral time constant, the performance of the PI controllers is affected by parameter variations, load disturbances and speed variations. The complexity of PI controller tuning and high response time is overcome by Fuzzy controller.

This paper gives an evolutionary Fuzzy PID controller design method for a PMSM. First, we develop a Fuzzy PID control design method based on the common control engineering knowledge that transient performance can be improved if the P and I gains are increased and the D gain is decreased when the transient error is large. We derive an inequality condition which the PID parameter should satisfy for asymptotic stability. Second, we give an Evolutionary Algorithm (EA) to optimize and auto tune the Fuzzy PID control parameters. Unlike the most previous methods, it is shown in our paper that any Fuzzy control parameter vector generated by the proposed evolutionary auto tuning algorithm guarantees the closed-loop stability.

## II. PROBLEM FORMULATION

A field oriented vector controlled isotropic PMSM dynamic equation is shown in (1):

$$\dot{\omega}(t) = \varphi_1 i_{qs}(t) - \varphi_2 \omega(t) - \varphi_3 T_L(t) \quad (1)$$

where  $\omega = \dot{\theta}$  is the electrical rotor angular speed,  $\theta$  is the electrical rotor angle,  $T_L$  represents the load torque disturbance input, and  $\varphi_i > 0$ ,  $i=1 \dots 3$  are the parameter values given by

$$\begin{aligned} \varphi_1 &= \frac{3}{2} \frac{1}{J} \frac{p^2}{4} \lambda_m \\ \varphi_2 &= \frac{B}{J} \\ \varphi_3 &= \frac{P}{2J} \end{aligned} \quad (2)$$

where  $p$  is the number of poles,  $J$ ,  $B$ , and  $\lambda$  are the rotor inertia, the viscous friction coefficient, and the magnetic flux, respectively. Field oriented PMSM control system is shown in Fig. 1. In a field oriented PMSM controller, the three phase current commands are computed by converting the controller current commands  $i_{qsd}$  and  $i_{dsd}$ . The d axis reference current is usually set as zero. Thus our problem can be formulated as proposing an EA based fuzzy PID speed control algorithm to generate the q- axis reference current command  $i_{qsd}$  for the system model. Parameter values are represented in (2).

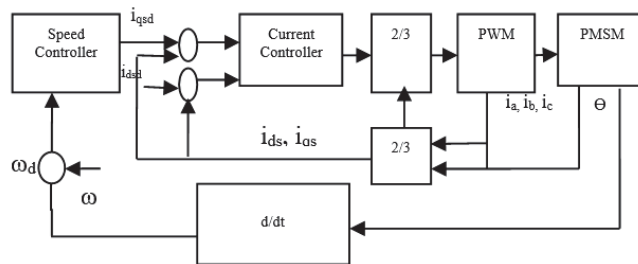

Fig. 1 Block Diagram of Field Oriented PMSM Control System

## III. PID CONTROLLER

A proportional integral derivative controller (PID controller) is a generic control loop feedback mechanism (controller) widely used in industrial control systems. A PID is the most commonly used feedback controller. A PID controller calculates an "error" value as the difference between a measured process variable and a desired setpoint. The controller attempts to minimize the error by adjusting the process control inputs. In the absence of knowledge of the underlying process, a PID controller is the best controller. However, for best performance, the PID parameters used in the calculation must be tuned according to the nature of the system, while the design is generic, the parameters depend on the specific system. Effects of coefficients is shown in Table I.

TABLE I  
EFFECTS OF COEFFICIENTS

Parameter	Speed of Response	Stability	Accuracy
increasing $K_p$	increases	deteriorate	improves
increasing $K_i$	decreases	deteriorate	improves
increasing $K_d$	increases	improves	no impact

## IV. P CONTROLLER

P controller is mostly used in first order processes with single energy storage to stabilize the unstable process. The main usage of the P controller is to decrease the steady state error of the system. As the proportional gain factor  $K_p$  increases, the steady state error of the system decreases. However, despite the reduction, P control can never manage to eliminate the steady state error of the system. By increasing the proportional gain, it provides smaller amplitude and phase margin, faster dynamics satisfying wider frequency band and larger sensitivity to the noise. P controller is used only when our system is tolerable to a constant steady state error. In addition, it can be easily concluded that applying P controller decreases the rise time and after a certain value of reduction on the steady state error, increasing  $K_p$  only leads to overshoot of the system response. P control also causes oscillation if sufficiently aggressive in the presence of lags and/or dead time. The more lags (higher order), the more problem it leads. Plus, it directly amplifies process noise.

## V. PI CONTROLLER

PI controller is mainly used to eliminate the steady state error resulting from P controller. However, in terms of the speed of the response and overall stability of the system, it has

a negative impact. This controller is mostly used in areas where speed of the system is not an issue. Since PI controller has no ability to predict the future errors of the system it cannot decrease the rise time and eliminate the oscillations. If applied, any amount of I guarantees set point overshoot.

### VI. PID CONTROLLER

PID controller has the optimum control dynamics including zero steady state error, fast response (short rise time), no oscillations and higher stability. The necessity of using a derivative gain component in addition to the PI controller is to eliminate the overshoot and the oscillations occurring in the output response of the system. One of the main advantages of the PID controller is that it can be used with higher order processes including more than single energy storage.

### VII. EVOLUTIONARY (GENETIC) FUZZY LOGIC CONTROLLER

It is one of the most successful approaches to hybridize Fuzzy systems with learning and adaption method apart from neural network. Genetic Fuzzy systems are soft computing paradigm which focuses on the design and generation of Fuzzy rules using evolutionary algorithm. It can solve complex real world problems which are difficult to be solved by conventional systems. Genetic Fuzzy system is shown in Fig. 2.

The Michigan-style genetic fuzzy rule-based system is a machine learning system which employs linguistic rules and fuzzy sets in its representation and is ideal for the rule discovery. Genetic Algorithms are search algorithms based on natural genetics that provide robust search capabilities in complex spaces and thereby offer a valid approach to problems requiring efficient and effective search processes. This approach mainly used in all type of probabilistic optimization problems and is inspired by biological evolution process. A Genetic Algorithm maintains a population of candidate solution for the problem at hand, and makes it evolve by iteratively applying a set of stochastic operators. The operators mainly used are mutation and crossover.

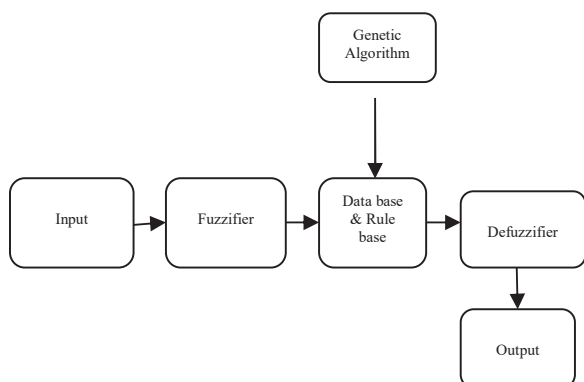

Fig. 2 Genetic Fuzzy System

The flowchart for Evolutionary (genetic) algorithm is shown in Fig. 3.

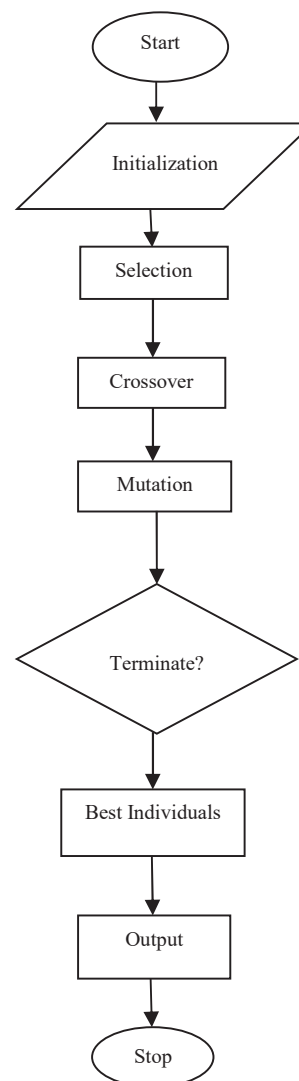

Fig. 3 Flowchart for Evolutionary Algorithm

The general GA is as follows,

- Step 1:create a random initial state: an initial population is created from a random selection of solutions. This is unlike a AI (artificial intelligence) where the initial state is already given.
- Step 2:evaluate fitness: a value for fitness is assigned to each solution depending on how close it actually is to solving the problem.
- Step 3:reproduce: those chromosomes with a higher fitness values are more likely to reproduce offspring. The offspring is a product of the father and mother; whose composition consists of a combination of genes from the two.
- Step 4:next generation: if the next generation contains a solution that produce an output that is close enough, then the problem has been solved. If this is not the case, then the new generation will go through the same process as their parents. This will continue until a solution is reached.

EA's are used to autotune the Fuzzy PID Parameters. The EA based Fuzzy PID controller provides better transient performances and the instability and steady state errors are overcome by using this method.

The above steps imply that the maximum generation number, the population size, crossover rate, mutation rate are the essential parameters of an Evolutionary algorithm.

Evolutionary algorithm is used to autotune the Fuzzy PID parameters which is represented in following steps.

#### A. Encoding/Decoding of Chromosome

Fuzzy PID control parameters are represented as a chromosome which is depicted in (3)-(5):

$$K_n^P = \prod_{j=1}^{n-1} \alpha_j \bar{K}^P \quad n = 1, 2, 3 \dots \quad (3)$$

$$K_n^I = \prod_{j=1}^{n-1} \beta_j \bar{K}^I \quad n = 1, 2, 3 \dots \quad (4)$$

$$K_n^D = \prod_{j=1}^{n-1} \gamma_j \bar{K}^D \quad n = 1, 2, 3 \dots \quad (5)$$

where  $\bar{K}^P$ ,  $\bar{K}^I$ ,  $\bar{K}^D$  are the maximum PID gains which can be calculated from the tuning methods. Triangular membership function is used for finding the final solution.

It should be noted that  $\alpha_i \in [0,1], \beta_i \in [0,1], \gamma_i \in [0,1], (i=1, 2, \dots, n)$ , then the stability conditions represented in (6) and (7) are always satisfied.

$$\begin{aligned} K_1^P &\geq K_2^P \geq \dots \geq K_{n-1}^P \geq K_n^P \geq 0, \\ K_{2n-1}^P &\geq K_{2n-2}^P \geq \dots \geq K_{n+1}^P \geq K_n^P \geq 0, \\ K_1^I &\geq K_2^I \geq \dots \geq K_{n-1}^I \geq K_n^I \geq 0, \\ K_{2n-1}^I &\geq K_{2n-2}^I \geq \dots \geq K_{n+1}^I \geq K_n^I \geq 0, \\ 0 &\leq K_1^D \leq K_2^D \leq \dots \leq K_{n-1}^D \leq K_n^D, \\ 0 &\leq K_{2n-1}^D \leq K_{2n-2}^D \leq \dots \leq K_{n+1}^D \leq K_n^D. \end{aligned} \quad (6)$$

$$K_n^P > 0 \quad K_n^I > 0 \quad K_n^D > 0 \quad (7)$$

#### B. Initialization

Before we actually start to autotune the Fuzzy PID parameters we need to set essential parameters of EA and also create the  $N_p * N_v$  initial population matrix  $P_0$  whose entries are randomly generated values between 0 and 1.

#### C. Fitness Function and Selection

We rank the chromosomes according to their fitness function (J). Fitness function is calculated by using (8):

$$J = \left( \int_0^{t_f} [\omega_c^2(t) + (1/\rho) i_{qsd}^2(t)] dt \right)^{-1} \quad (8)$$

where  $\rho$  is positive design parameter and simulation time is  $t_f$ . if  $\rho$  is large, then the fluctuations can be removed, otherwise magnitude of the controller current command  $i_{qsd}$  will be affected heavily. Using the above fitness function, we evaluate the Fuzzy PID control laws corresponding to the  $N_p$  chromosomes and we rank the chromosomes according to their fitness value. Next we select the best  $X_r N_p$  chromosomes into a mating pool for reproduction.

#### D. Crossover

Randomly take two parents from the mating pool ( $C_m$ , and  $C_d$ ) and we obtain one offspring  $C_o$  which is shown in (9):

$$c_o = c_m - \eta(c_m - c_d) \quad (9)$$

where  $\eta$  is a random value between 0 and 1. Repeat this procedure until we obtain  $(1 - X_r) N_p$  offspring.

#### E. Mutation

In mutation process,  $X_m (1 - X_r) N_p N_v$  genes are randomly selected from the  $(1 - X_r) N_p$  offspring, and the selected genes are replaced with uniform random numbers between 0 and 1. After undergoing the mutation process, the  $(1 - X_r) N_p$  offspring form a new  $N_p * N_v$  population matrix  $P_{k+1}$  together with  $X_r N_p$  chromosomes of the mating pool.

#### F. Stopping Criteria

If the maximum fitness value becomes larger than a prescribed value, we terminate the algorithm and we choose the best chromosome as the final solution. Otherwise, if the maximum generation number is reached, we stop. Chromosomes generated by our method will guarantee the closed loop stability.

### VIII. SIMULATION RESULTS

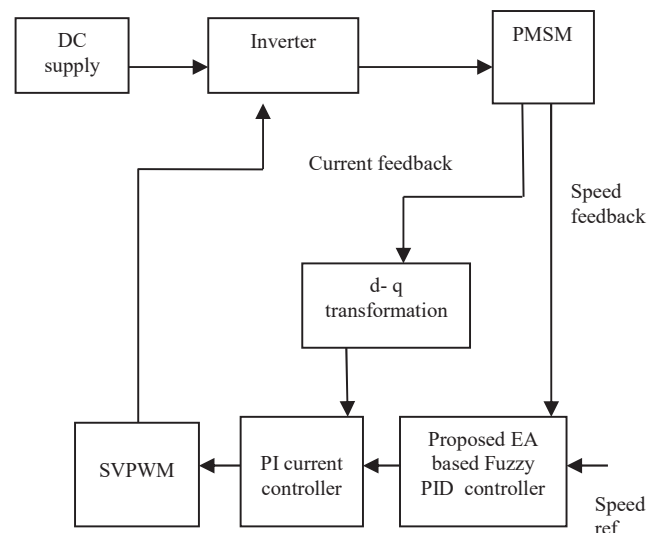

Fig. 4 Block Diagram of EA Based Fuzzy PID Controller

Fig. 4 illuminates the block diagram of the proposed EA based Fuzzy PID controller.

The DC supply is given to the inverter. The output from the inverter (i.e. three phase AC supply) is connected with Permanent Magnet Synchronous Motor (PMSM). The current feedback from the motor is given to the dq transformation block. The speed feedback is given to the Proposed EA based

fuzzy PID controller. The output from, both dq transformation block and Proposed EA based fuzzy PID controller is given to the PI current controller. The SVPWM block which generates PWM pulses for inverter. Simulation circuit for EA based Fuzzy PID controller is depicted in Fig. 5.

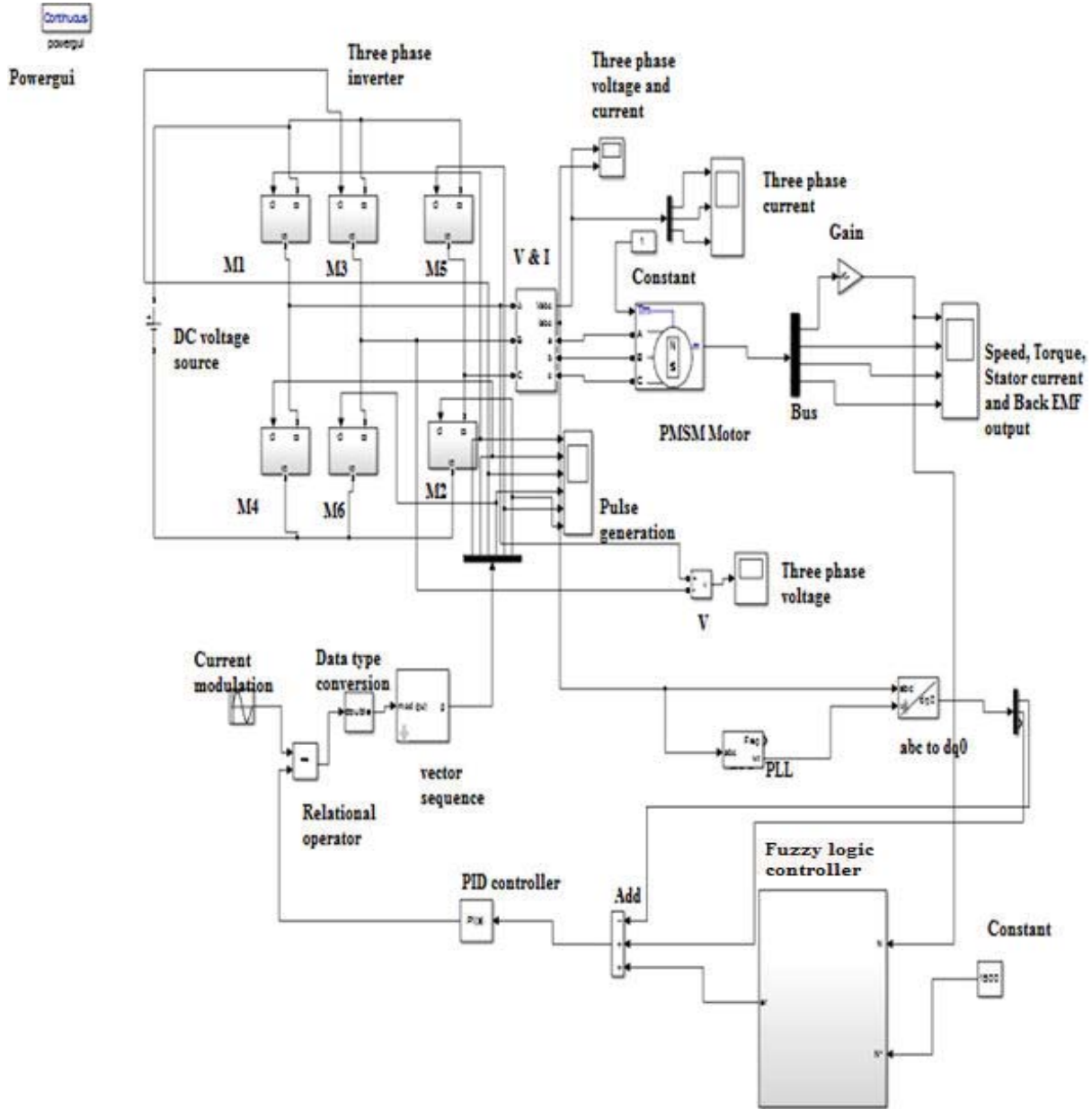

Fig. 5 Simulation Circuit for EA Based Fuzzy PID Controller

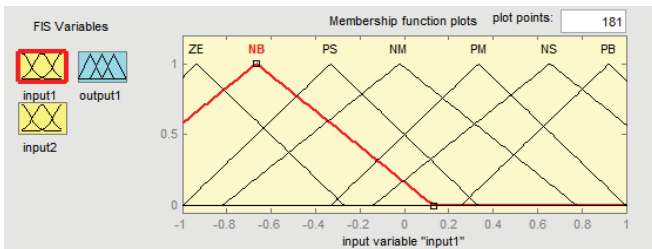

Fig. 6 Membership Function Value for Input 1

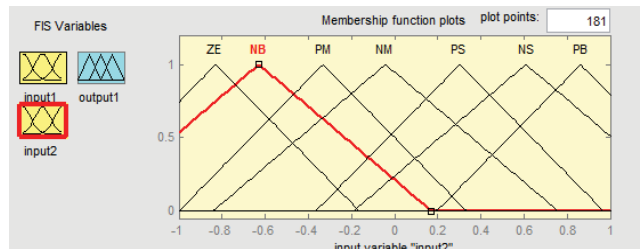

Fig. 7 Membership Function Value for Input 2

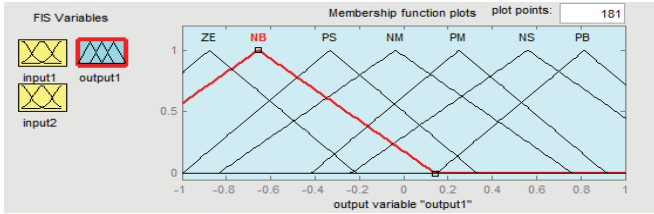

Fig. 8 Membership Function Output

Fig. 6 shows the Membership Function value of input 1. Fig. 7 shows the Membership Function value of input 2. Comparison between the membership values is depicted in Fig. 8.

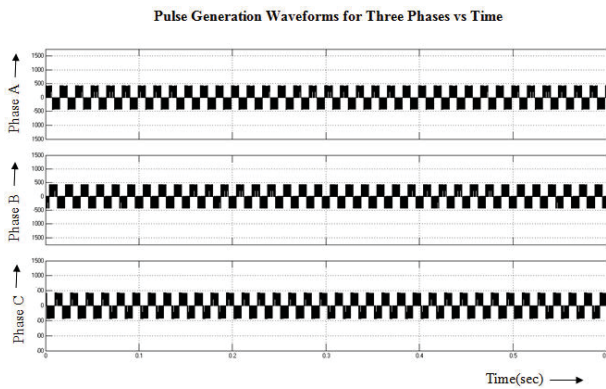

Fig. 9 Pulse Width Waveform

Pulse width for each phase is shown in Fig. 9. It shows the changes in width of the pulses with respect to amplitude and time of the pulses.

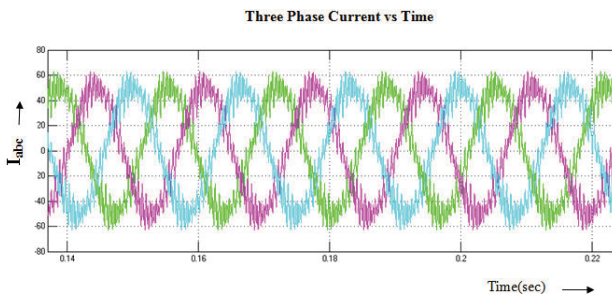

Fig. 10 Waveform for Three Phase Current

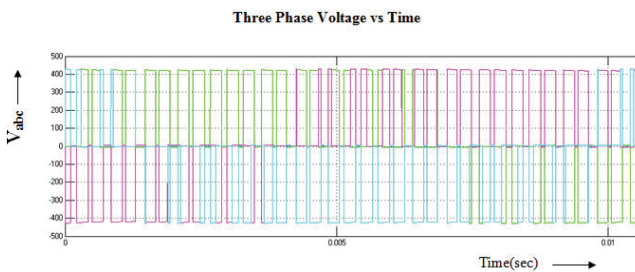

Fig. 11 Waveform for Three Phase Voltage

The voltage waveforms for three phases with respect to time is shown in Fig. 11. The current waveforms for three phases with respect to time is shown in Fig. 10.

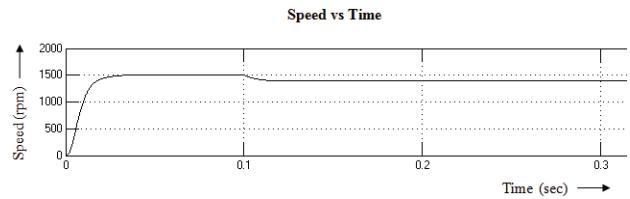

Fig. 12 Speed Waveform for PMSM

EA based Fuzzy PID controller is used for controlling the speed of PMSM. The set speed is 1500 rpm. By using the EA based Fuzzy PID controller the speed is obtained as 1488 rpm which is depicted in Fig. 12.

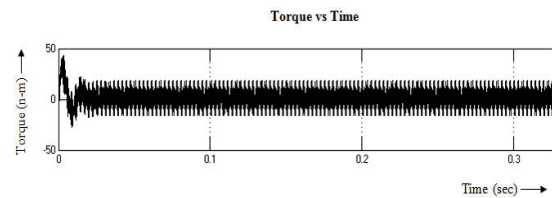

Fig. 13 Torque Waveform for PMSM

The torque is varied from +20 N-M to -20 N-M which is shown in Fig. 13. The fluctuations in torque is also reduced by using the EA based Fuzzy PID controller.

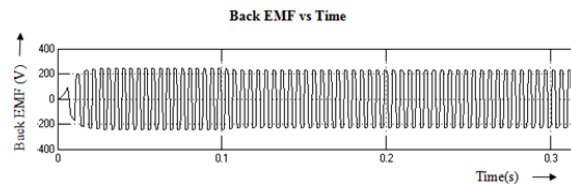

Fig. 14 Back EMF Waveform

The Back EMF waveform for PMSM is varied from +200V to -200V which is obtained by using the EA based Fuzzy method is shown in Fig. 14.

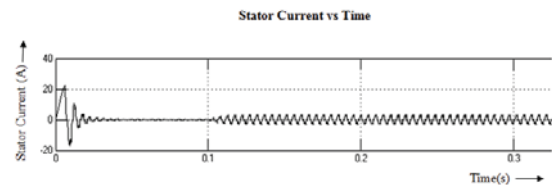

Fig. 15 Waveform for Stator Current

Fig. 15 shows the Stator current characteristics of PMSM with respect to time. The stator current is varied from +4A to -4A with respect to time.

## IX. CONCLUSION

In this work, a new Evolutionary Algorithm based Fuzzy PID controller for PMSM drives is proposed. Fuzzy PID

control design problem is obtained based on common control engineering knowledge. Good transient performance can be obtained by increasing P and I gains and decreasing D gain when transient error is large. Then EA is used to autotune the Fuzzy PID control parameters. The speed control of PMSM is achieved by using this method. This method also provides better dynamic performance and good stabilization. The results show that, the proposed control technique gives better performance as the motor torque and speed control is better than that of the conventional type. The proposed EA based Fuzzy PID Controller can be implemented in real time without any concern about instability problems that leads to system damage (or) failure. EA based Fuzzy PID speed controller has been designed successfully for closed loop operation of the PMSM drive system so that the motor runs at the commanded or reference speed. The simulated system has a fast response with practically zero steady state error thus validating the design method of the speed controller.

**M. Umabharathi** received her B.E in Electrical and Electronics Engineering from Anna University, Chennai, India in 2014, her M.E in Power Electronics and Drives from Anna University, Chennai, India in 2016. She is a student member in the Department of Electrical and Electronics Engineering, P.A. College of Engineering and Technology, Coimbatore, India. Her field of interest includes Power Electronics and Machines. Email ID: bharathi9865@gmail.com

**Dr. S. Vijayabaskar** received his B.E in Electrical and Electronics Engineering from Bangalore University, India in 1999, his M.E in Power Systems from Annamalai University, Chidambaram, India in 2000 and Ph.D in the field of Optimization and stability of power distribution system with FACTS devices at Anna University, Chennai, India. He is an Associate Professor in the Department of Electrical and Electronics Engineering, P.A. College of Engineering and Technology, Coimbatore, India. His research interest includes optimal location and power flow control with FACTS devices. Email ID: svbkec@gmail.com

#### REFERENCES

- [1] M. Preindl and S. Bolognani (2013), 'Model predictive direct torque control with finite control set for PMSM drive systems, Part 2: Field weakening operation,' *IEEE Trans. Ind. Inf.*, vol. 9, no. 2, pp. 648–657.
- [2] N. T.-T. Vu, D.-Y. Yu, H. H. Choi, and J.-W. Jung (2013), 'T-S fuzzy model based sliding mode control for surface mounted permanent magnet synchronous motors considering uncertainties,' *IEEE Trans. Ind. Electron.*, vol. 60, no. 10, pp. 4281–4291.
- [3] K. Jezemik, R. Horvat, and M. Curkovic (2013), 'A switching control strategy for the reduction of torque ripple for PMSM,' *IEEE Trans. Ind. Inf.*, vol. 9, no. 3, pp. 1272–1279.
- [4] G. Liu, L. Chen, W. Zhao, Y. Jiang, and L. Qu (2013), 'Internal model control of permanent magnet synchronous motor using support vector machine generalized inverse,' *IEEE Trans. Ind. Inf.*, vol. 9, no. 2, pp. 890–898.
- [5] M. Morawiec (2013), 'The adaptive backstepping control of permanent magnet synchronous motor supplied by current source inverter,' *IEEE Trans. Ind. Inf.*, vol. 9, no. 2, pp. 1047–1055.
- [6] H. H. Choi and J.-W. Jung (2013), 'Discrete time fuzzy speed regulator design for PM synchronous motor,' *IEEE Trans. Ind. Electron.*, vol. 60, no. 2, pp. 600–607.
- [7] T. D. Do, H. H. Choi, and J.-W. Jung (2012), 'SDRE based near optimal control system design for PM synchronous motor,' *IEEE Trans. Ind. Electron.*, vol. 59, no. 11, pp. 4063–4074.
- [8] H. H. Choi, N. T.-T. Vu, and J.-W. Jung (2011), 'Digital implementation of an adaptive speed regulator for a PMSM,' *IEEE Trans. Power Electron.*, vol. 26, no. 1, pp. 3–8.
- [9] H. H. Choi, V. Q. Leu, V. Q., Y.-S. Choi, and J.-W. Jung (2011), 'Adaptive speed controller design for a permanent magnet synchronous motor,' *IET Electr. Power Appl.*, vol. 5, no. 5, pp. 457–464.
- [10] J.-W. Jung, Y.-S. Choi, V. Q. Leu, and H. H. Choi (2011), 'Fuzzy PI type current controllers for permanent magnet synchronous motors,' *IET Electr. Power Appl.*, vol. 5, no. 1, pp. 143–152.
- [11] Y.-S. Kung, C.-C. Huang, and M.-H. Tsai (2009), 'FPGA realization of an adaptive fuzzy controller for PMSM drive,' *IEEE Trans. Ind. Electron.*, vol. 56, no. 8, pp. 2923–2932.
- [12] S. Li and Z. Liu (2009), 'Adaptive speed control for permanent-magnet synchronous motor system with variations of load inertia,' *IEEE Trans. Ind. Electron.*, vol. 56, no. 8, pp. 3050–3059.
- [13] C.-K. Lin, T.-H. Liu, and S.-H. Yang (2008), 'Nonlinear position controller design with input-output linearisation technique for an interior permanent magnet synchronous motor control system,' *IET Power Electron.*, vol. 1, no. 2, pp. 14–26.
- [14] A. V. Topalov, G. L. Cascella, V. Giordano, F. Cupertino, and O. Kaynak (2007), 'Sliding mode neuro-adaptive control of electric drives,' *IEEE Trans. Ind. Electron.*, vol. 54, no. 1, pp. 671–679.
- [15] M. Cheng, Q. Sun, and E. Zhou (2006), 'New self-tuning fuzzy PI control of a novel doubly salient permanent magnet motor drive,' *IEEE Trans. Ind. Electron.*, vol. 53, no. 3, pp. 814–821.