

Modeling of Masonry In-Filled R/C Frame to Evaluate Seismic Performance of Existing Building

Tarek M. Alguhane, Ayman H. Khalil, M. N. Fayed, Ayman M. Ismail

Abstract—This paper deals with different modeling aspects of masonry infill: no infill model, Layered shell infill model, and strut infill model. These models consider the complicated behavior of the in-filled plane frames under lateral load similar to an earthquake load. Three strut infill models are used: NBCC (2005) strut infill model, ASCE/SEI 41-06 strut infill model and proposed strut infill model based on modification to Canadian, NBCC (2005) strut infill model. Pushover and modal analyses of a masonry infill concrete frame with a single storey and an existing 5-storey RC building have been carried out by using different models for masonry infill. The corresponding hinge status, the value of base shear at target displacement as well as their dynamic characteristics have been determined and compared. A validation of the structural numerical models for the existing 5-storey RC building has been achieved by comparing the experimentally measured and the analytically estimated natural frequencies and their mode shapes. This study shows that ASCE/SEI 41-06 equation underestimates the values for the equivalent properties of the diagonal strut while Canadian, NBCC (2005) equation gives realistic values for the equivalent properties. The results indicate that both ASCE/SEI 41-06 and Canadian, NBCC (2005) equations for strut infill model give over estimated values for dynamic characteristic of the building. Proposed modification to Canadian, NBCC (2005) equation shows that the fundamental dynamic characteristic values of the building are nearly similar to the corresponding values using layered shell elements as well as measured field results.

Keywords—Masonry infill, framed structures, RC buildings, non-structural elements.

I. INTRODUCTION

THE concrete frame structures provided with masonry panels are widely spread in many countries. In these structures, exterior masonry walls and/or interior partitions, usually regarded as nonstructural architectural elements, are built as an infill between the frame members. The usual practice in the structural design of infill-frames is to ignore the structural interaction between the frame and infill. However, infill-frames have often demonstrated good earthquake-resistant behavior, at least for serviceability level earthquakes in which the masonry infill can provide enhanced stiffness and strength. Due to the change in stiffness and mass of the structural system, the dynamic characteristics change as well. In several moderate earthquakes, such buildings have shown

Tarek M. Alguhane, Doctor of structural, is with the King Abdullah WAQF, KSA (phone: 00966505375200; e-mail: tarijuha@hotmail.com).

Ayman Hussin Professor of Structural Engineering, Ain Shams University, Egypt (e-mail: ayman_hh_khalil@yahoo.com).

M. N. Fayed, Professor of Structural Engineering, Ain Shams University, Egypt (e-mail: mnourf@yahoo.com).

Ayman M. Ismail, Professor of Structural Engineering, HBRC, Egypt (e-mail: ayman.m.ismail@gmail.com).

excellent performance during earthquake.

The seismic design of masonry in-filled RC frame buildings is handled in different ways across the world.

The research studied by Sattar [1], about the infill-frame interaction, points out some difficulties related to the variety and uncertainty of the parameters involved, the complexity of the models and the experimental investigation. The scientific literature offers a variety of models, which can be grouped in two classes. The first one includes micro-modeling approaches, in which the RC frame, the masonry panel, and their mutual connections are individually modeled and described by proper constitutive laws. The second class, usually defined as “macro-modeling approach”, is the most widely used, and the method of the “equivalent strut” is the most popular. Therefore, the infill-frame interaction has become a research focus for seismic analysis of buildings and there is a need to do more work in this field for local building in the Kingdom of Saudi Arabia.

ASCE/SEI 41-06 [2] is a guideline providing assistance in seismic assessment and rehabilitation of reinforced concrete buildings with infill walls. The document is based on FEMA 356 [3] and it provides guidelines on assessment and rehabilitation of a wide range of building types. For masonry, infill is modeled as the compression strut with possibility of forming axial hinge, as recommended by ASCE/SEI 41-06 for the calculations of strengths and effective stiffness of the infill panels. The accuracy of the ASCE/SEI 41-06 in estimating the strut width adjacent to infill walls was investigated through groups of experimental and theoretical study by Fenerci [4]. The results indicated that the strut width estimated by ASCE/SEI 41-06 is considerably small compared to the analysis results of the strut stiffness in macro models.

In the present study, pushover analysis and modal analysis of a masonry infill concrete frame with a single storey and an existing 5-storey RC building have been carried out by using different models for masonry infill. These models include: no infill model, Layered shell infill model, and strut infill model. Three strut infill models are used: proposed strut infill model, NBCC (2005) [5] strut infill model and ASCE/SEI 41-06 strut infill model. The hinge status, base shear at target displacement, fundamental periods and their mode shapes are compared. The results are summarized and discussed.

II. MODELLING TYPES OF MASONRY INFILL IN RC FRAMES

In order to model the complicated behavior of the in-filled plane frames under lateral load similar to an earthquake load, a criterion for the frame in-filled separation is used, [6], [7]. The main goal of this criterion is to find a valid geometrical

equilibrium condition for the composite structure of the in-filled frame under certain loading conditions, given that the real overall behavior of an infill frame is a complex statically indeterminate problem. Fig. 1 shows the deformed meshes of one-story one-bay in-filled frame using method of contact points.

Several methods have been developed on modeling in-fills, and they are grouped in two main categories: macro-models, based on the equivalent strut method, and micro-models, based on the finite element method.

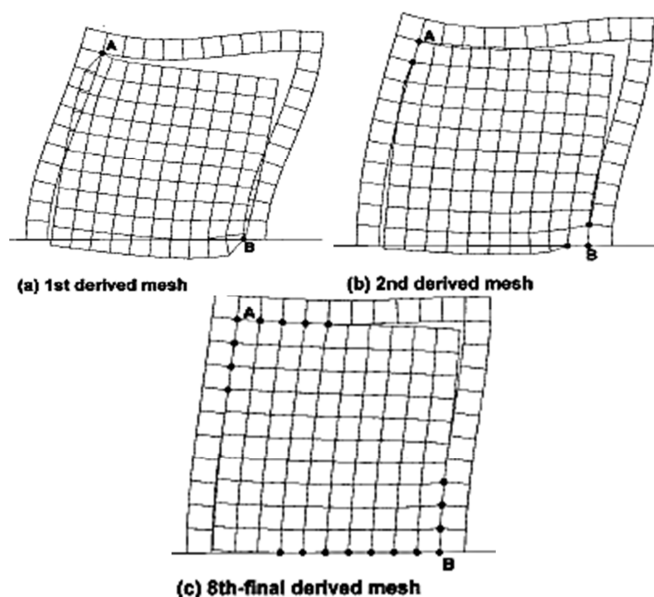

Fig. 1 Deformed meshes of one-story one-bay infill frame using method of contact points, [7]

A. Micro-Models

The commonest micro-model is the finite element model, which has been extensively used for modeling in-filled frame structures. As in-filled frames are a composite structural type, different elements are required in the model: beam elements for the surrounding frame, continuum elements for the masonry panel and interface elements for representing the interaction between the frame and the panel. Finite element models exhibit obvious advantages for describing the behavior of in-filled frames, and the local effects related to cracking, crushing and contact interaction. On the other hand, this implies a greater computational effort and more time in preparing the input data and in analyzing the results. From the first approach developed by [8] using the finite element method for the analysis of 2D in-filled frames, different alternatives have been proposed by using a micro-model. Among these, we could mention [9]-[12] or [7].

The multi-layer shell elements are used for modeling of masonry infill, [13]. The shell element is made up of many layers and material properties are assigned to various layers. This multi-layer shell element can simulate the coupled in-plane/out-plane bending and the coupled in-plane bending-shear nonlinear behaviors of masonry infill panel. Basic principles of multi-layer shell element are illustrated by Fig. 2.

The shell element is made up of many layers with different thick-ness.

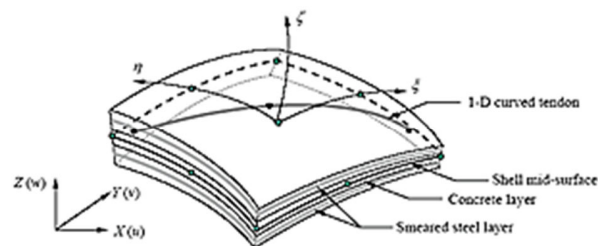

Fig. 2 Multi-layer shell element

B. Equivalent Strut (Macro-Model)

The main advantages of macro-modeling are computational simplicity and the use of structural mechanical properties obtained from masonry tests, since the masonry is a very heterogeneous material and the distribution of material properties of its constituent elements is difficult to predict. Holmes [14] was the first in replacing the infill by an equivalent pin-jointed diagonal strut. Stafford Smith [15] proposed a theoretical relation for the width of the diagonal strut based on the relative stiffness of infill and frame. Alternative proposals were given by [11], [16]-[19].

In the last decades, it has become clear that one single strut is not sufficient to model the complex behavior of the in-filled frame. This is because the local effects resulting from the interaction of the infill with the surrounding frame are not apparent if only the two loaded corners of the frame are connected through a single strut. As a result, bending moments and shear forces in the frame members are not modeled realistically and the location of potential plastic hinges cannot be adequately predicted. More complex macro-models were then proposed by many researchers [20]-[22] based on two, three or multiple diagonal struts, Fig. 3. Despite of increasing complexity, the main advantage of these models is the ability to reflect the actions in the frame more accurately.

Samoilă [23] concluded from his study that the single-strut model is better to be used in analysis regarding the general behavior of in-filled frames, because it can be accepted as correct and due to its simplicity, while the three-strut model is the appropriate approach for determining the local effects of frame infill interaction. The equivalent strut shall have the same thickness and modulus of elasticity as the infill panel it represents, Fig. 4. The tensile strength of masonry is negligible and only compression diagonal strut is liable to resist the lateral load properties of brick masonry infill. The Strut is provided with hinges at ends to so that the strut does not carry any moment, [6], and [24].

The effective width of equivalent strut in the infill wall proposed by different researchers has severe variation. The review of the current practice as applied in modeling of masonry in-fills has led to that Formulation given by [17] for equivalent diagonal strut is the simplest of all the methods. Haris et. el. [25] investigated three different numerical models and compared the results with experimental results.

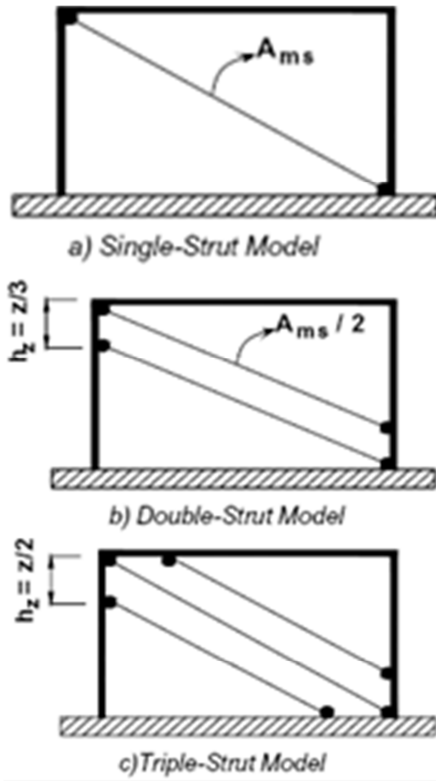

Fig. 3 Modified strut models adapted from [20]

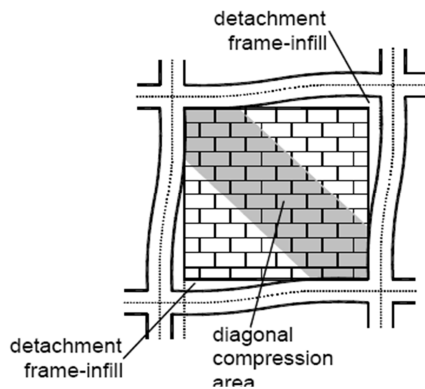

Fig. 4 Strut model analogy of in-filled frames

III. EMPIRICAL EQUATIONS FOR EQUIVALENT STRUT (MACRO MODELS)

A. ASCE/SEI 41

The masonry infill is modeled as single strut element with possibility of forming axial hinge, Fig. 1. ASCE/SEI 41-06 gives the following equation for the calculation of the width (a_1) of the equivalent compression strut that represents the in plane stiffness of a solid un-reinforced masonry infill panel before cracking:

$$a_1 = 0.175(\lambda_1 h_{col})^{-0.4} r_{inf} \quad (1)$$

where,

$$\lambda_1 = \left[\frac{E_{me} t \sin \theta}{4E_c I_c h_{inf}} \right]^{\frac{1}{4}}$$

h_{col} = Column height between center lines of the beams; h_{inf} = Height of the infill panel; E_c = Expected modulus of elasticity of the frame material; E_{me} = Expected modulus of elasticity of the infill material; I_c = Moment of inertia of the column; L_{inf} = Length of the infill panel; r_{inf} = Diagonal length of the infill panel; t = Thickness of the infill panel and equivalent strut; θ = Angle whose tangent is the infill height-to length aspect ratio.

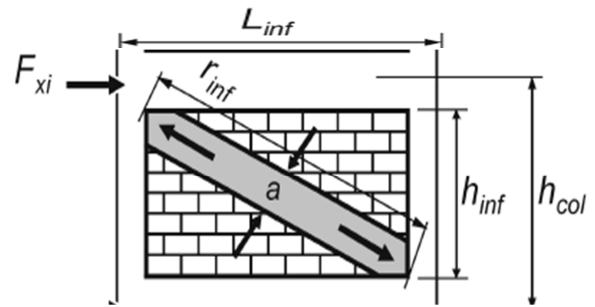

Fig. 5 Compression strut analogy—concentric Struts, ASCE/SEI 41-06
 B. NBCC 2005

NBCC 2005 [5] and CSA S304.1 (2004) [26] give the following equation for the calculation of the Diagonal strut width w as follows, Fig. 2:

$$w = \sqrt{\alpha_h^2 + \alpha_L^2} \quad (2)$$

where:

$$\alpha_h = \frac{\pi}{2} \left[\frac{4E_c I_c h}{E_m t_e \sin 2\theta} \right]^{\frac{1}{4}}$$

$$\alpha_L = \frac{\pi}{2} \left[\frac{4E_c I_b l}{E_m t_e \sin 2\theta} \right]^{\frac{1}{4}}$$

where α_h = vertical contact length between the frame and the diagonal strut; α_L = horizontal contact length between the frame and the diagonal strut; E_m, E_f = modulus of elasticity of the masonry wall and frame material, respectively; h, l = height and length of the infill wall, respectively; t_e = sum of the thickness of the two face shells for hollow or semi-solid block units and the thickness of the wall for solid or fully grouted hollow or semi-solid block units; I_c, I_b = moments of inertia of the column and the beam of the frame respectively; θ = angle of diagonal strut measured from the horizontal; d = diagonal length of the infill panel.

The effective diagonal strut width, w_e , to be used for the calculation of the compressive strength of the strut should be taken $w_e = w/2$ or $l_s/4$, whichever is the least.

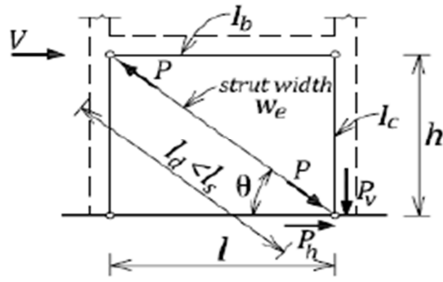

Fig. 6 Diagonal strut model, NBCC 2005 [5]

C. Proposed Strut Infill Model to Account for the Dynamic Characteristic of Building

In case of the cross diagonal struts, [27] suggested that the axial stiffness coefficient $E_{strut} A_{strut}$ can be expressed in terms of the shear stiffness $G_w A_w$ of the infill panel and the inclination (θ) of the strut as:

For a single diagonal strut:

$$E_{strut} \cdot A_{strut} = G_w \cdot A_w / (\cos 2\theta \cdot \sin \theta) \quad (3)$$

For the cross diagonal struts:

$$2 (E_{strut} \cdot A_{strut}) = G_w \cdot A_w / (\cos 2\theta \cdot \sin \theta) \quad (4)$$

Using the relation between the axial stiffness of the strut and the shear stiffness of the panel, the axial stiffness coefficient $E_{strut} A_{strut}$ can be determined. Equation (4) can be approximately satisfied by two assumptions:

- The width of the strut calculated according to the limitation of Canadian, NBCC (2005) [5] should be not more than 0.25 the strut length.
- The modulus of elasticity of the masonry wall, E_m and the shear modulus, G_w are calculated such as $E_m = 550 (f_m)$ and the shear modulus, $G_w = 0.40 (E_m) \nu$, here, f_m is the compressive strength of the masonry wall material, ASCE 41-06 and Euro-code (2006) [28].

IV. PUSHOVER ANALYSIS METHOD

A pushover analysis is performed by subjecting a structure to a monotonically increasing pattern of lateral loads, representing the inertial forces which would be experienced by the structure when subjected to ground shaking. Under incrementally increasing loads various structural elements may yield sequentially. Consequently, at each event, the structure experiences a loss in stiffness. Using a pushover analysis, a characteristic nonlinear force displacement relationship can be determined.

A representation of the monotonic load-deformation relationship is given in Fig. 7. The values of the deformations (or rotations) at the points B, C and D should be derived from experiments or rational analysis. Three points labeled IO (Immediate Occupancy), LS (Life Safety) and CP (Collapse Prevention) are used to define the acceptance criteria for the hinge. The recommended plastic rotation capacities for RC columns and beams controlled by flexure are given ATC-40

[29] and FEMA 356 [3].

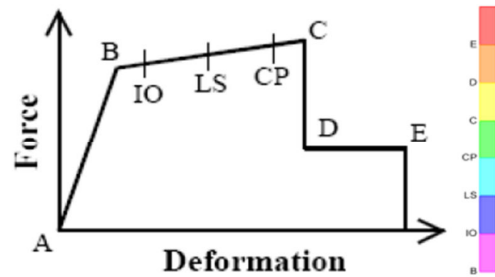

Fig. 7 Generalized force-deformation relation for elements or components

V. COMPARATIVE EXAMPLE: SINGLE STORY FRAME

A. Descriptions and Mathematical Models

The studied frame was assumed to be single story, and the columns and beams of the frame were modeled using two-noded frame or beam elements. Masonry infill walls (fair condition according to ASCE 41-06, were modeled as:

- Finite elements using shell elements.
- Equivalent diagonal struts, (D), (one strut and two struts) using two noded beam elements;

Four modeling possibilities were considered, Fig. 8, as follows:

- (i) No infill model (bare frame only),
- (ii) Layered shell infill model,
- (iii) One diagonal strut infill model,
- (iv) Cross diagonal strut infill model.

Different values of E_{strut} and equivalent width of the diagonal strut according to suggested limitation to eqs. (3) and (4), ASCE/SEI 41-06 equation and Canadian, NBCC (2005) equation have been calculated. These values are:

- $E_{strut} = 7.0 \text{ E}+6 \text{ kN/m}^2$ and equivalent width $w = 0.25 d$ according to suggested limitation to (3).
- $E_{strut} = 4.0 \text{ E}+6 \text{ kN/m}^2$ and equivalent width $w = 0.25 d$ according to suggested limitation to (4).
- $E_{strut} = 2.2 \text{ E}+6 \text{ kN/m}^2$ and equivalent width $w = 0.25 d$ according to Canadian, NBCC (2005) (2).
- $E_{strut} = 2.2 \text{ E}+6 \text{ kN/m}^2$ and equivalent width $w = 0.11 d$ according to ASCE/SEI 41-06 (1).

The properties of the materials are those presented in Table I. Stress-strain curves for concrete, steel bars and brick wall are illustrated in Fig. 9.

TABLE I
MATERIAL PROPERTIES

concrete strength	F'_c	20000 kN/m ²
rebar yield strength	F_y	243000 kN/m ²
modulus of elasticity of concrete	E_c	2.0E+7 kN/m ²
modulus of elasticity of rebar	E_s	2.0E+8 kN/m ²
Shear modulus	G	1.035E+7 kN/m ²
Poisson's ratio	ν	0.2
Compressive Strength of infill wall	f_m	4000 kN/m ²
modulus of elasticity of infill wall	E_{infill}	2.2 E+6 kN/ m ²

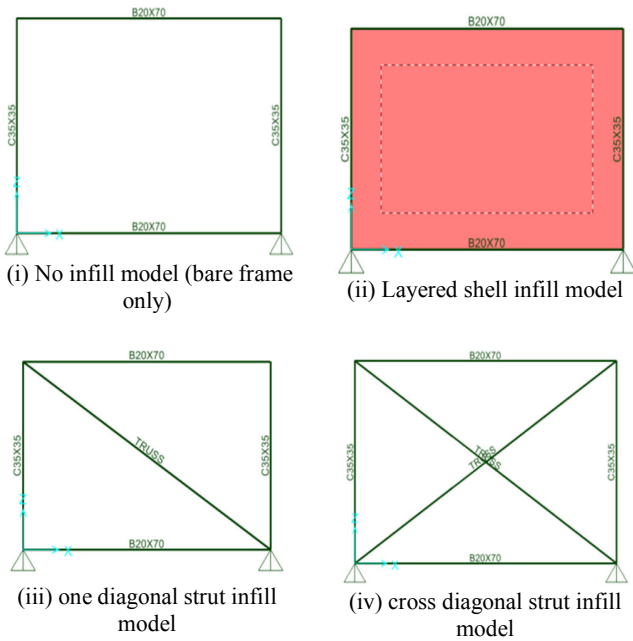
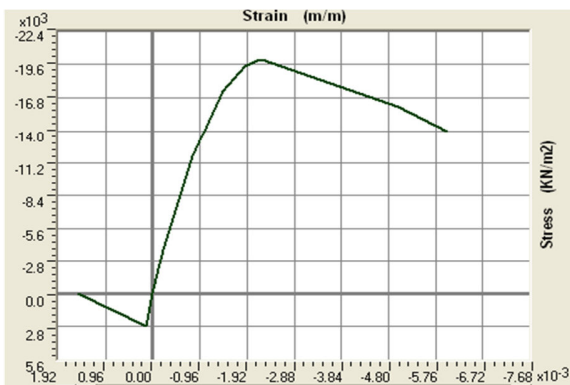

Fig. 8 Four different modeling for the comparative example

B. Results and Discussion

Pushover analysis (Nonlinear static analysis) and Modal analysis were carried out using SAP2000 [30] software in order to determine hinge status and base shear at target displacement.



(a) Stress-strain curve for concrete

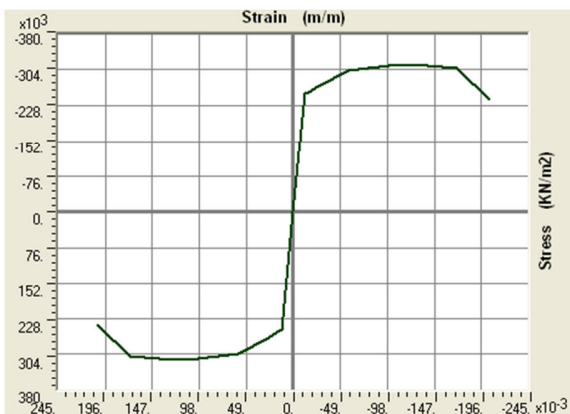

(b) Stress-strain curve for steel bars

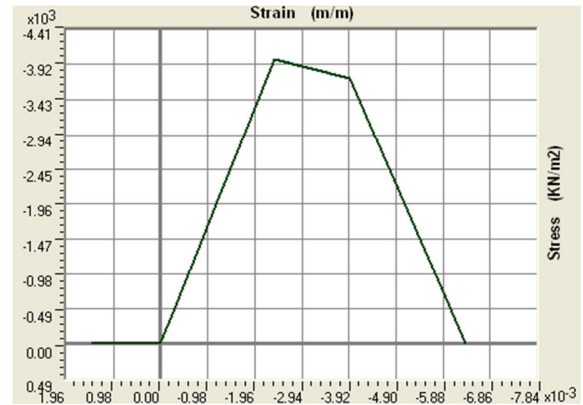

(c) Stress-strain curve for clad brick

Fig. 9 Stress-strain curves for comparative example

1. Case A: Micro-Model and Macro-Model

The pushover curves (top displacement vs. base shear) are shown in Fig. 10 for no infill model (bare frame only), Layered shell infill model, and proposed strut infill model (one diagonal or cross diagonal). Infill wall thickness= 0.25m. Table II illustrates the corresponding hinge status and the value of base shear at target displacement as well as the fundamental dynamic characteristic and its mode shape.

The results in Fig. 10 and Table II show that:

- The maximum base shear values for proposed strut infill model (one diagonal or cross diagonal), are in good agreement with those values for Layered shell infill model. However, cross diagonal strut infill model is stiffer for the performance displacement than one diagonal strut infill model.
- The dynamic characteristic of the story infill frame show that proposed strut infill model (cross diagonal) has good representation compared to that of Layered shell infill model.

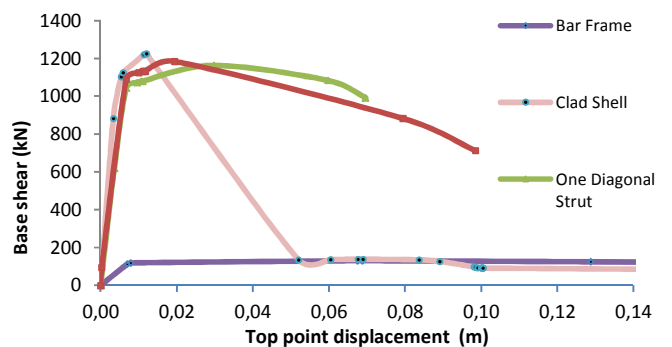

Fig. 10 Pushover curves for no infill model (bare frame only), Layered shell infill model, and proposed strut infill model (one diagonal or cross diagonal), t=0.25m

TABLE II

BASE SHEAR AND FIRST MODE SHAPE FOR NO INFILL MODEL (BARE FRAME ONLY), LAYERED SHELL INFILL MODEL, AND PROPOSED STRUT INFILL MODEL (ONE DIAGONAL OR CROSS DIAGONAL), $T = 0.25M$

Tem	Base Shear V_B (kN)	Fundamental Mode Shape T_1 (sec.)
No infill model	 $V_B = 130$	 $T_1 = 0.482$
Layered shell infill model	 $V_B = 1225$	 $T_1 = 0.106$
Proposed one diagonal strut model	 $V_B = 1169$	 $T_1 = 0.116$
Proposed cross diagonal strut model	 $V_B = 1207$	 $T_1 = 0.107$

TABLE III

BASE SHEAR AND FIRST MODE SHAPE FOR NBCC (2005) STRUT INFILL MODEL AND ASCE/SEI 41-06 STRUT INFILL MODEL, (ONE DIAGONAL OR CROSS DIAGONAL), $T = 0.25M$

Item	Base Shear V_B (kN)	Fundamental Mode Shape, T_1 (sec.)
NBCC (2005) one diagonal strut infill model	 $V_B = 1207$	 $T_1 = 0.178$
NBCC (2005) cross diagonal strut infill model	 $V_B = 1225$	 $T_1 = 0.131$
ASCE/SEI 41-06 one diagonal strut infill model	 $V_B = 612$	 $T_1 = 0.244$
ASCE/SEI 41-06 cross diagonal strut infill model	 $V_B = 665$	 $T_1 = 0.185$

2. Case B: Empirical Code Equations for Macro-Models (Equivalent Strut)

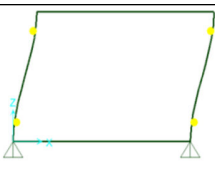
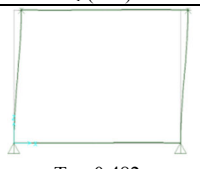
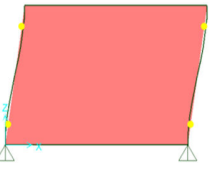
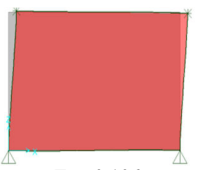
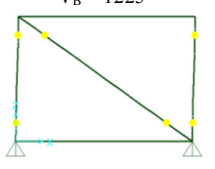
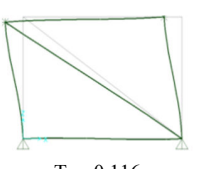
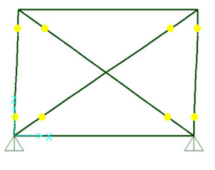
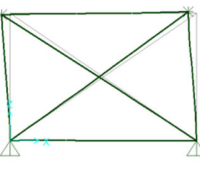
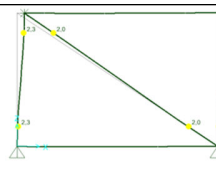
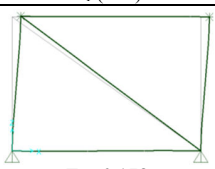
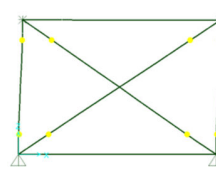
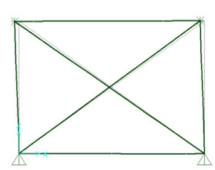
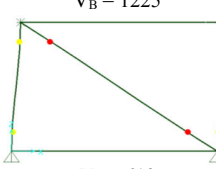
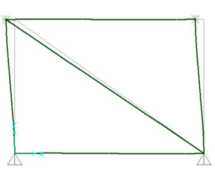
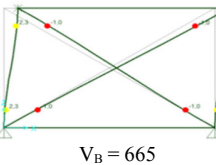
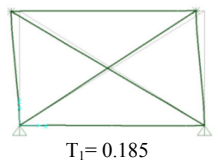
The pushover curves (top displacement vs. base shear) are shown in Fig. 11 for NBCC (2005) strut infill model and ASCE/SEI 41-06 strut infill model, (one diagonal or cross diagonal). Infill wall thickness = 0.25m. The hinge status, the value of base shear at target displacement and the fundamental mode shape are shown in Table III.

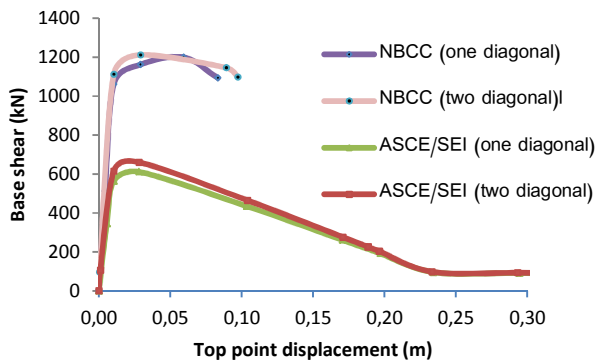
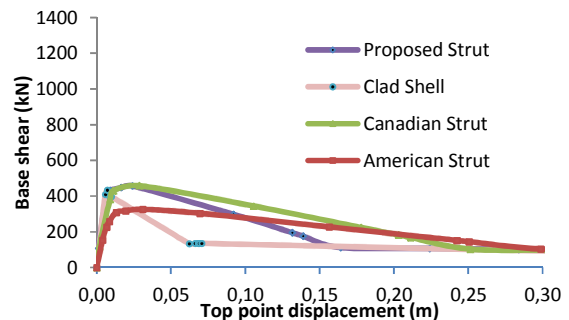

Fig. 11 Pushover curves for NBCC (2005) strut infill model and ASCE/SEI 41-06 strut infill model, (one diagonal or cross diagonal), $t=0.25m$

The results in Fig. 11 and Table III show that:

- Modeling infill wall with one diagonal strut has maximum base shear value almost similar to that value when modeling with cross diagonal strut. However, there is a considerable variation for the dynamic characteristic depending on strut infill model (one diagonal or cross diagonal).
- For NBCC (2005) strut infill model (one diagonal or cross diagonal), the maximum base shear as well as the dynamic characteristic values are much greater than those values for ASCE/SEI 41-06 strut infill model. These values of both N) strut infill model and ASCE/SEI 41-06 strut infill model have big differences as compared to those values of Layered shell infill model.



(a) Thickness = 0.06m

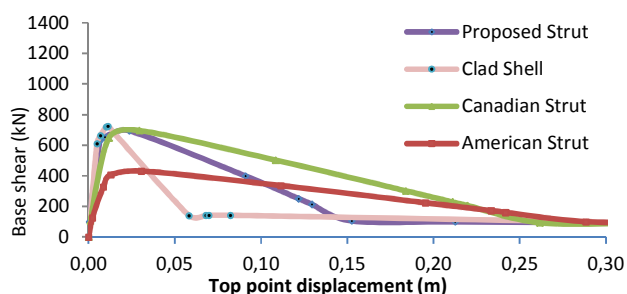

(b) Thickness = 0.12m

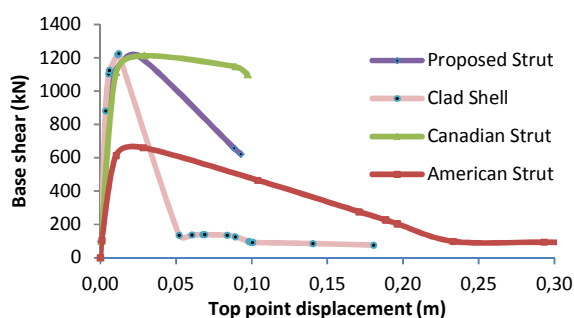

(c) Thickness = 0.25m

Fig. 12 Pushover curves for Layered shell infill model, proposed strut infill model, NBCC (2005) strut infill model and ASCE/SEI 41-06 strut infill model, (cross diagonal).

3. Case C: Effect of Changing Infill Wall Thickness

The maximum base shear values from pushover curves as well as the fundamental dynamic characteristic values are summarized in Tables IV and V for different infill wall models. These models are layered shell infill model, proposed strut infill model, NBCC (2005) strut infill model and ASCE/SEI 41-06 strut infill model, (cross diagonal). Three values of infill wall thickness have been considered, i. e. 0.06 m, 0.12 m and 0.25m.

TABLE IV
BASE SHEAR VALUES FOR DIFFERENT INFILL THICKNESS USING DIFFERENT INFILL MODELS

Item	Layered shell infill model	Base Shear V_B (kN)		
		Proposed strut infill model	NBCC (2005) strut infill model	ASCE/SEI 41-06 strut infill model
Infill thickness (m)	0.06	433	461	325
	0.12	722	695	437
	0.25	1225	1207	665

TABLE V
FIRST MODE SHAPE FOR DIFFERENT INFILL THICKNESS USING DIFFERENT INFILL MODELS

item	Fundamental Mode Shape value (sec.)			
	Layered shell infill model	Proposed strut infill model	NBCC (2005) strut infill model	ASCE/SEI 41-06 strut infill model
Infill thickness (m)	0.06	0.195	0.196	0.310
	0.12	0.146	0.147	0.258
	0.25	0.106	0.107	0.185

VI. APPLICATION TO FIVE STORY BUILDING IN MADINAH CITY

A. Description and Mathematical Models

The structure is an existing five-story reinforced concrete moment frame building in Madinah City [27], [31], [32]. The building is used as a hotel. The location of the building and plan of a typical story above basement are shown in Figs. 13-16. Fig. 17 shows plan and elevation for building dimensions. This 5-storey R C building consists of reinforced concrete skeleton i.e. columns, beams and solid slab. The thickness of brick walls is almost equal 0.12 m and the storey height is about 3.00 m. Super-imposed Dead Load and live loads are taken equal to 3.0 kN/ m² 2.0 kN/m² respectively.

Material properties and reinforced concrete member sizes and reinforcement for the building are illustrated in Table VI and Fig. 13 respectively. Stress-strain curves for concrete, steel bars and brick wall are illustrated in Fig. 14.

For the five stories building, three mathematical models, Model I, Model II and Model III were created using SAP2000 [21] program, Fig. 14, as:

- Model I: No infill model (bare frame only)
- Model II: Layered shell infill model
- Model III: Strut infill model (three strut infill models are used i. e. proposed strut infill model, NBCC (2005) strut infill model and ASCE/SEI 41-06 strut infill model).

B. Results and Discussion

Pushover analysis (Nonlinear static analysis) and Modal analysis were carried out using SAP2000 software in order to determine hinge status and base shear at target displacement.

1) Hinge Status and Base Shear at Target Displacement for Pushover Analysis

The static nonlinear analysis combined the application of the dead load followed by the application of the lateral seismic forces, which were increased up to failure under displacement control. Displacement-controlled pushover analyses were performed on different models for the 5-storey RC building. Fig. 15 shows the pushover curves up to failure for building models: Model I, Model II, and Model III in X direction and in Y direction respectively. Further, Table VII illustrates base shear at target displacement and the corresponding hinge status for the studied models. The maximum base shear capacity in x and y directions is plotted as bar line for the studied models as shown in Figs. 16 and 17, respectively.

TABLE VI
MATERIAL PROPERTIES

concrete strength	F'_c	20000 kN/m ²
rebar yield strength	F_y	243700 kN/m ²
modulus of elasticity of concrete	E_c	2.0E+7 kN/m ²
modulus of elasticity of rebar	E_s	2.0E+8 kN/m ²
Shear modulus	G	1.035E+7 kN/m ²
Poisson's ratio	ν	0.2



Fig. 13 Side view of the case study building in Madinah

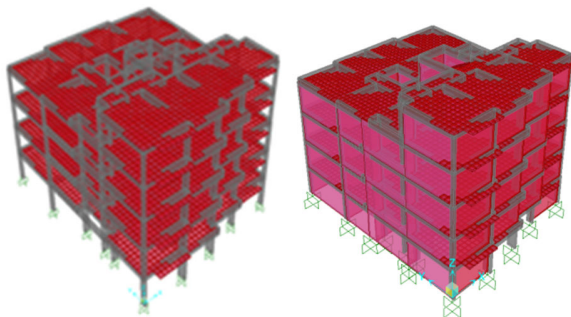

Model I: No infill model Model II: Strut infill model

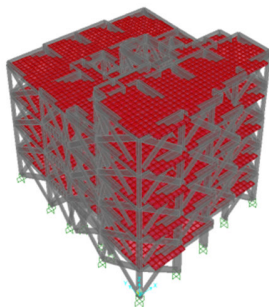

Model III: Layered shell infill model

Fig. 14 Different modeling for 5-storey R.C building

From Figs. 15-18, it is observed that:

- Modeling building with infill walls has greater strength as compared to building without infill walls.
- The maximum base shear values from pushover curves for proposed strut infill model and NBCC (2005) strut infill model are in good agreement with that value for layered shell infill model. However, in case of modeling infill wall according to ASCE/SEI 41-06 strut infill model, the maximum base shear value is considerably low for all studied cases.
- The value of the fundamental dynamic characteristic of the proposed strut infill model has good representation compared to that value of Layered shell infill model. Both NBCC (2005) strut infill model and ASCE/SEI 41-06 strut infill model has considerable different values as

compared to that value of Layered shell infill model.

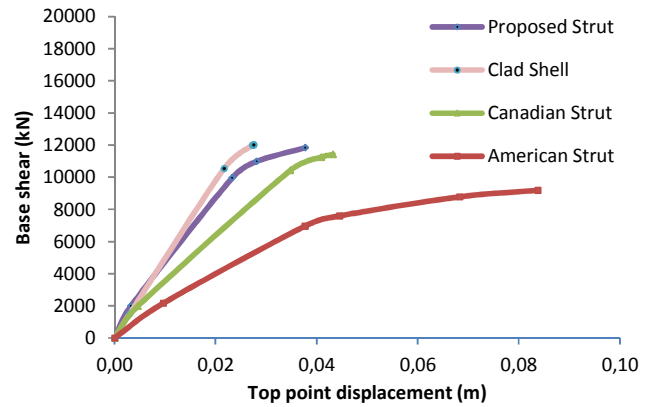

(a) Static nonlinear analysis X-X

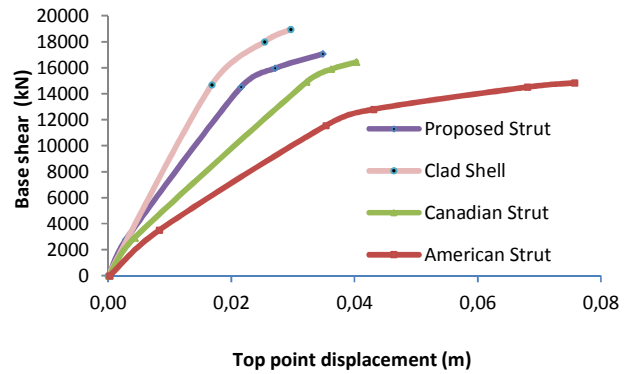

(b) Static nonlinear analysis Y-Y

Fig. 15 Comparison of pushover curves for the four models

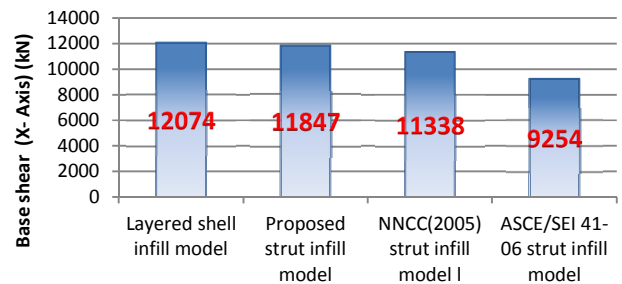

Fig. 16 Comparison of pushover curves for the four models (about X-axis)

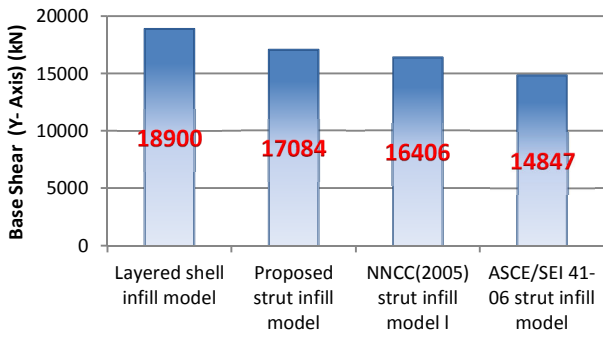
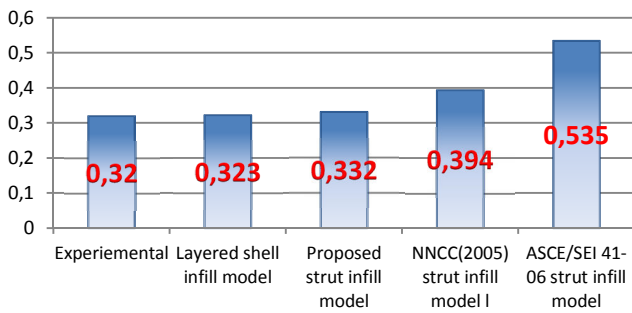
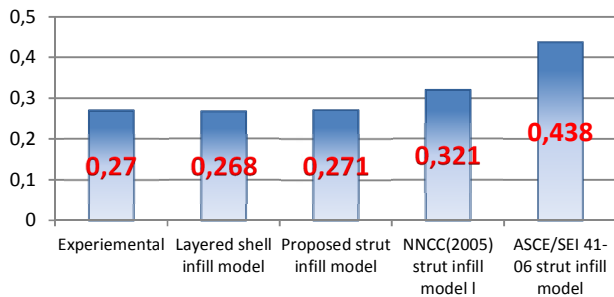

Fig. 17 Comparison of pushover curves for the four models (about Y-axis)



(a) First Mode Periods (sec)



(b) Second Mode Periods (sec)

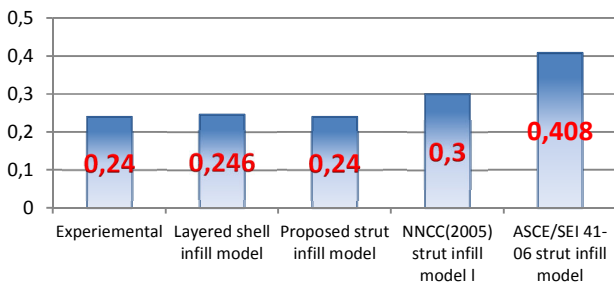

(c) Third Mode

Fig. 18 Mode shapes for different infill Models

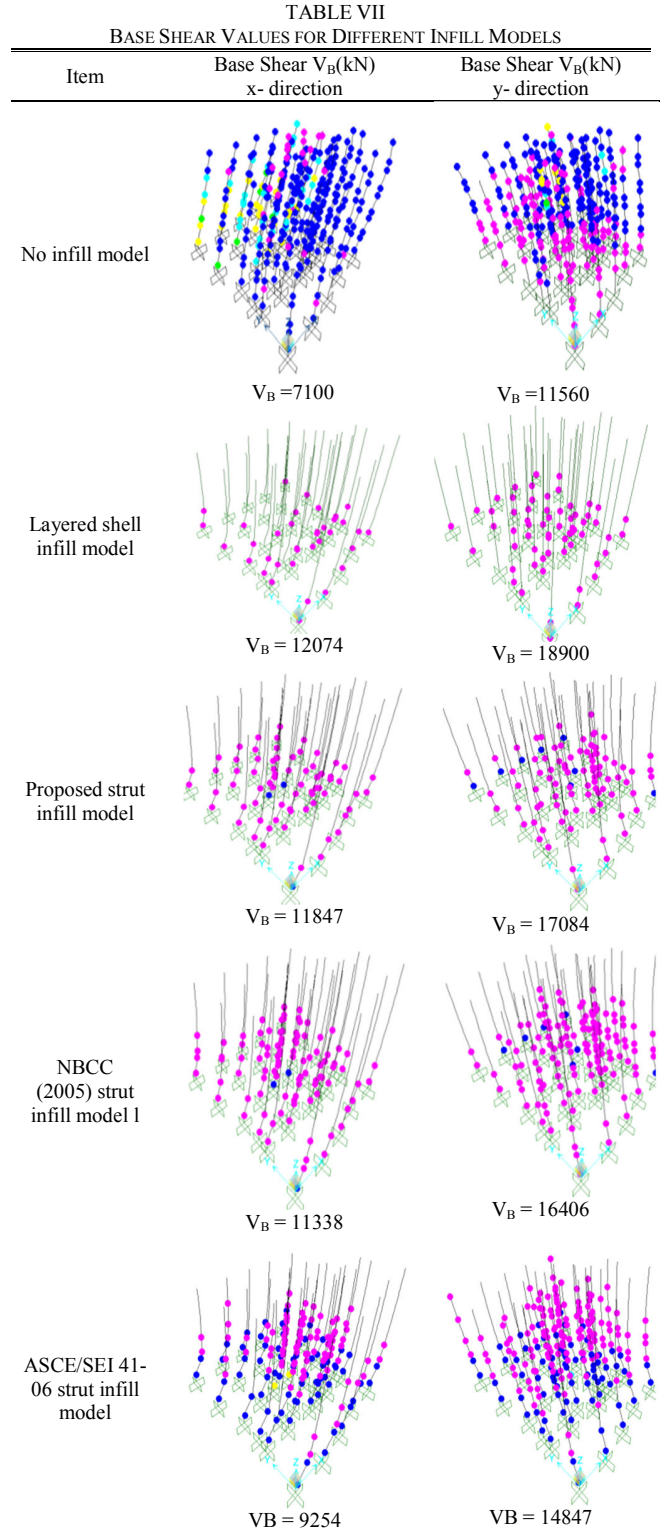

2) Experimental and Theoretical Frequencies as well as Mode Shapes

The fundamental frequencies and the corresponding mode shapes for this 5-storey RC building were determined using ambient vibration measurements, [27]. The theoretical natural frequencies and their mode shapes have been determined. Accordingly, a study has been conducted using modal analysis

to assess fundamental transverse, longitudinal, and tensional periods of the building and to determine the accuracy of considering infill walls in structural model. Modal analysis has been carried out for different models of the building using SAP2000 program.

Table VIII shows the first three natural periods measured for the building i.e. 0.32 sec, 0.27 sec and 0.24 sec. as well as

the corresponding transverse, longitudinal and tensional mode shapes. The first theoretical three natural periods and the corresponding transverse, longitudinal and tensional mode shapes are also shown in Table VIII for different infill models. The values of the first three natural periods are plotted as bar line for the studied models as shown in Fig. 18.

TABLE VIII
 NATURAL PERIODS AND MODE SHAPES FOR DIFFERENT INFILL MODELS

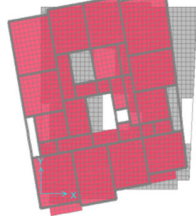
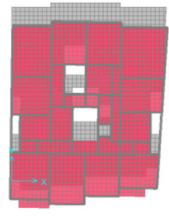
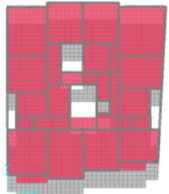
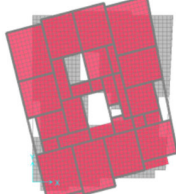
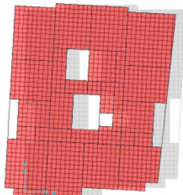
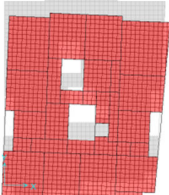
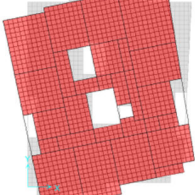
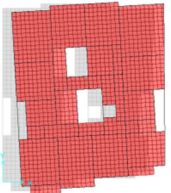
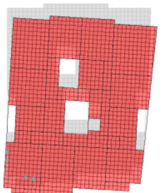
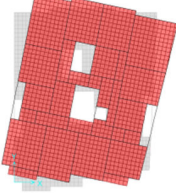
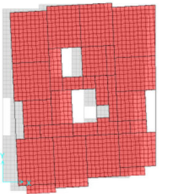
Item	First Mode Shape (sec.)	Second Mode Shape (sec.)	Third Mode Shape (sec.)
Experimental	 T ₁ =0.32 (Translation X)	 T ₂ =0.27 (Translation Y)	 T ₃ =0.24 (Coupled)
No infill model	 T ₁ =0.950 sec	 T ₂ =0.902 sec	 T ₃ =0.637 sec
Layered shell infill model	 T ₁ =0.323 sec	 T ₂ =0.268 sec	 T ₃ =0.246 sec
Proposed strut infill model	 T ₁ =0.332 sec	 T ₂ =0.271 sec	 T ₃ =0.24 sec
NBCC (2005) strut infill model I	 T ₁ =0.394 sec	 T ₂ =0.321 sec	 T ₃ =0.30 sec
ASCE/SEI 41-06 strut infill model	 T ₁ =0.535 sec	 T ₂ =0.438 sec	 T ₃ =0.408 sec

From the analysis investigations presented in Table VIII and Fig. 18, the following remarks can be seen:

- Modeling the building with infill wall shows the importance of contribution of infill walls in changing dynamic characteristic of the building. The existing infill walls have been adjusted to give results similar to those obtained in field.
- Modeling the building without infill wall, Model I (No infill model), gives different results for both period values and corresponding mode shapes. The first and second periods i.e. 0.950 sec and 0.902 sec are torsion modes while the third period i. e. 0.637 sec is transverse mode in Y direction.
- A good agreement was found between the experimentally measured periods i.e. 0.32 sec, 0.27 sec and 0.24 sec. and the numerically calculated periods with the infill wall, Model II(Layered shell infill model) i.e. 0.323 sec, 0.268 sec and 0.246 sec. The corresponding mode shapes in transverse, longitudinal, and tensional directions are similar.
- The values of the first three natural periods of the proposed strut infill model i.e. 0.332 sec, 0.271 sec and 0.24 sec has good representation compared to those values of Layered shell infill model as well as experimentally measured periods. The values of both NBCC (2005) strut infill model i.e. 0.394 sec, 0.321 sec and 0.30 sec and ASCE/SEI 41-06 strut infill model i.e. 0.535 sec, 0.438 sec and 0.408 sec have considerable different values as compared to that value of Layered shell infill model.
- By considering the above facts, the main result of the study is that the contribution of infill walls should be carefully judged by considering the importance of them in changing dynamic response and collapse status of existing RC structures.

VII. CONCLUSIONS

- Both Canadian, NBCC (2005) and proposed strut infill model give realistic values for the equivalent properties of the diagonal strut when compared to analysis using layered shell elements.
- ASCE/SEI 41-06 equation underestimates the values for the equivalent properties of the diagonal strut. As a result, it reduces significantly the contribution of infill walls in RC building. According to the report by EERI/PEER (2006), the deformation limits provided by ASCE/SEI 41-06 were found to be overly conservative.
- Using proposed strut infill model with suggested limitation gives realistic values for the fundamental period of the building when compared to corresponding value using layered shell elements as well as measured field results. Field measurements and numerical analyses for different models of an existing 5 storey building asses the results.
- Both ASCE/SEI 41-06 equation and Canadian, NBCC (2005) give over estimated values for fundamental period of the frame.

REFERENCES

- [1] S. Sattar, Influence of masonry infill walls and other building characteristics on seismic collapse of concrete frame buildings (Ph.D. thesis), University of Colorado, Boulder, Colo, USA, 2013.
- [2] ASCE/SEI 41, (2006) "Seismic Rehabilitation of Existing Buildings, American Society of Civil Engineers, Reston, Virginia
- [3] FEMA 356 (2000), "Pre-standard and Commentary for seismic re-habitation of buildings", Federal Emergency Management Agency, Washington, D.C.
- [4] Fenerci, A., (2013) "The Effect of Infill Walls on the Seismic Performance of Boundary Columns in RC Frames" M. Sc. Thesis, Middle east technical university.
- [5] NBCC (2005). National Building Code of Canada 2005, National Research Council, Ottawa.
- [6] Asteris PG. (2008) "Finite Element Micro-Modeling of Infilled Frames" Electronic Journal of Structural Engineering.
- [7] Asteris, P., Kakaletsis, D., Chrysostomou, C. and Smyrou, E. (2011) "Failure Modes of In-filled Frames" Electronic Journal of Structural Engineering 11(1).
- [8] Mallick DV, Severn RT. (1967) "The Behavior of In-filled Frames under Static Loading" Proceedings of the Institution of Civil Engineers, Vol. 38, pp. 639-656.
- [9] Riddington JR, Stafford Smith B. (1977) "Analysis of In-filled Frames Subject to Racking with Design Recommendation". Structural Engineer, Vol. 55(6), pp. 263-268.
- [10] Liaw TC, Kwan KH. (1982) "Non-linear Analysis of Multi Story In-filled Frames" Proceedings of the Institution of Civil Engineers, Vol. 73(2), pp. 441-454.
- [11] Liaw TC, Kwan KH. (1984) "Nonlinear Behavior of Non-Integral In-filled Frames" Comput. Struct. 18, 551-560.
- [12] Dhanasekar, M., Page, A.W., (1986) "The Influence of Brick Masonry Infill Properties on the Behavior of In-filled Frames" Proc. Inst. Civ. Engrs., London, 81, 593 – 605.
- [13] Miao, Z. W. Lu1, X. Z. Jiang1, J. J. and Ye, L. P. (2006) " Nonlinear FE Model for RC Shear Walls Based on Multi-layer Shell Element and Microplane Constitutive Model Computational Methods in Engineering and Science EPMESC, Sanya, Hainan, China.
- [14] Holmes M. (1961) "Steel Frames with Brickwork and Concrete Infilling" Proceedings of the Institution of Civil Engineers 19.
- [15] Stafford Smith B, Carter C. (1969) "A Method of Analysis for Infill Frames" Proc. Inst. Civil Eng.
- [16] Mainstone RJ. (1974) "On the Stiffness and Strength of In-filled Frames" Proc. Supplement, Trans. of Inst. Of Civil Eng. State Univ. of New York.
- [17] Paulay, T. and Priestley, M.J.N. (1992) "Seismic Design of Reinforced Concrete and Masonry Buildings", John Wiley & Sons, New York, United States.
- [18] Durrani, A. J., and Luo, Y. H. (1994) "Seismic Retrofit of Flat-Slab Buildings with Masonry Infills." NCEER, Workshop on Seismic Response of Masonry Walls.
- [19] Cavaleri L, Papia M. (2003) "A new Dynamic Identification Technique: Application to the Evaluation of the Equivalent Strut for Infilled Frames" Engineering Structures 25, 889-901.
- [20] Crisafulli, F. J., Carr, A. J., and Park, R (2000) "Analytical modeling of in-filled frame structures-A General Review" Bulletin of the New Zealand Society for Earthquake Engineering, 33(1), 30-47.
- [21] Crisafulli, J. and Carr, A. (2007) "Proposed macro-model for the analysis of in-filled frame structures "Bulletin of the New Zealand Society for Earthquake Engineering, Vol. 40, No. 2, June 2007.
- [22] Andreus U, Cerone M, D'Asdia P, Iannozzi F. (1985) "A Finite Element Model for the Analysis of Masonry Structures under Cyclic Actions" Proceedings of the Seventh International Brick and Masonry Conference, Melbourne, Australia, Vol. 1, pp. 479-488.
- [23] Samoila, D. (2012) "Analytical modeling of masonry in-fills", Civil Engineering and Architecture, 55(2), 2012, 127-136.
- [24] Asteris, P. G. (2003) "Lateral Stiffness of Brick Masonry In-filled Plane Frames", Journal of structural engineering, ASCE.
- [25] Haris, I., Hortobagyi, Z. (2012), "Comparison of experimental and analytical results on masonry infilled RC frames for cyclic lateral load", Periodica Polytechnic Civil Engineering.
- [26] CSA S304.1 (2004). Design of masonry structures. Canadian Standards Association, Mississauga, Canada.
- [27] Tarek M. Alguhane, (2014) "Monitoring of buildings structures in Madinah" Ph.D., Ain Shams University Faculty of Engineering 2014.

- [28] Eurocode 8, (EC8-2006), "Design of structures for earthquake resistance", Part 1: General rules, seismic actions and rules for buildings, Committee European de Normalization, Brussels, 2006.
- [29] ATC, "Seismic Evaluation and Retrofit of Concrete Building", ATC 40, 1996.
- [30] SAP2000, Integrated Software for Structural Analysis & Design. Computers & Structures, Inc., Berkeley, California, USA, 2011.
- [31] Alguhane, T. M., Khalil, A. H., Fayed, M. N., Ismail. A. M., (2015) "Seismic Assessment of Old Existing RC Buildings with Masonry Infill in Madinah as per ASCE". International Journal of Civil, Architectural, Structural and Construction Engineering, 9(1), 52-63.
- [32] Alguhane, T. M., Khalil, A. H., Fayed, M. N., Ismail. A. M.,(2015) "Seismic Assessment of Old Existing RC Buildings in Madinah with Masonry Infilled using Ambient Vibration Measurements" International Journal of Civil, Architectural, Structural and Construction Engineering, 9(1), 43-51.