

# 3D Shape Knitting: Loop Alignment on a Surface with Positive Gaussian Curvature

C. T. Cheung, R. K. P. Ng, T. Y. Lo, Zhou Jinyun

**Abstract**—This paper aims at manipulating loop alignment in knitting a three-dimensional (3D) shape by its geometry. Two loop alignment methods are introduced to handle a surface with positive Gaussian curvature. As weft knitting is a two-dimensional (2D) knitting mechanism that the knitting cam carrying the feeders moves in two directions only, left and right, the knitted fabric generated grows in width and length but not in depth. Therefore, a 3D shape is required to be flattened to a 2D plane with surface area preserved for knitting. On this flattened plane, dimensional measurements are taken for loop alignment. The way these measurements being taken derived two different loop alignment methods. In this paper, only plain knitted structure was considered. Each knitted loop was taken as a basic unit for loop alignment in order to achieve the required geometric dimensions, without the inclusion of other stitches which give textural dimensions to the fabric. Two loop alignment methods were experimented and compared. Only one of these two can successfully preserve the dimensions of the shape.

**Keywords**—3D knitting, 3D shape, loop alignment, positive Gaussian curvature.

## I. INTRODUCTION

THIS paper aims at creating 3D knitted shapes with positive Gaussian curvature surfaces by manipulating knitting loop alignments based on the shape's geometry. A sphere is a typical example of a surface with a constant positive Gaussian curvature value. To establish a concrete theory on 3D shape loop alignment, an object with a range of positive Gaussian curvature surfaces was used in this paper. And based on the geometric form of this object, 3D knitted shapes targeting to resume the object's dimensions were produced using two suggested loop alignment methods, method A and B. These two loop alignment methods were defined by their own dimensional information acquiring system, and loops were aligned according to their own system. However, a two-needle flat bed weft knitting machines were unable to create a 3D shape directly since the knitting mechanism is in 2D. The fabric being knitted grows in length upon a width depending on the number of needles being used. The fabric can be at a desired length and width but the third dimension, that the thickness cannot be changed. It is a 2D formation. A 3D shape is, therefore, required to be flattened into a 2D plane so that

Cheung C. T. is with the Institute of Textiles and Clothing, the Hong Kong Polytechnic University (phone: +852 9806 7152; e-mail: 13903460r@connect.polyu.hk).

Ng K.P. Roger is with the Institute of Textiles and Clothing, the Hong Kong Polytechnic University (e-mail: tengr@polyu.edu.hk).

Lo T.Y. is with the Institute of Textiles and Clothing, the Hong Kong Polytechnic University (e-mail: t.y.lo@polyu.edu.hk)

Zhou Jinyun is with the Institute of Textiles and Clothing, the Hong Kong Polytechnic University (e-mail: tczhoujy@polyu.edu.hk).

weft knitting becomes compatible. Knitting shaping techniques, which are able to produce knitwear with shapes, including stitch transfer and partial knitting were used [1], [2]. But in flattening a 3D surface, distortions in distances, areas, and angles must be induced simultaneously [3]. Unless the surface has zero Gaussian curvature, distance or area distortions are inevitable [4]. The parameter preserving criteria should be based on its application. For example, a map for navigation is a 2D plane with angles preserved flattened from the 3D Earth surface. Since the end use of the plane here is for aligning loops, preserving the area of the surface should be the prime consideration [5].

## II. METHODOLOGY

The general, the 3D surface of the target object is captured before it can be converted into a 2D plane compatible with the knitting process. Dimensional information of the plane is then attained for loop alignment. A knitting sequence is then developed according to the selected loop alignment method. The knitting sequence will result in a fabric with a shape possessing the geometry of the target object. Subsequently, the fabric has to undergo the necessary after treatments which may include linking and relaxation in order to reproduce the target 3D configuration. The finished knitted shape, retrieving the target 3D shape from 2D planes, is finally subject to evaluation, both quantitatively and qualitatively. To maintain the accuracy of the study, each experiment was repeated three times.

An egg-like shape with a flat base possessing a surface with a range of positive Gaussian curvature values was used in this study shown in Fig. 1.



Fig. 1 A digital image of the egg-like object

The whole surface of the shape except its base was taken for experiments. Knitting is carried out using a Shima Seiki SES-122S flatbed computerised knitting machine and the knitting programme was created using Shima Seiki SDS-One APEX3

Knit CAD system. One end 2/30 Nm 100% Merino Wool yarn was used for the 12-gauge knitting machine.

### III. SURFACE FLATTENING

Arranging knitting loops for creating a 3D form, the 3D surface is required to be flattened to become 2D so that knitting is compatible. Direct flattening will induce distance, area, and angle distortions and if knitting loop alignment is to follow an uncontrolled distorted plane, the knitted fabric will not be able to reconstruct the surface of the original 3D object. To retrieve the 3D surface of the shape, area-preservation flattening methods are considered more important than distance and angles. In this study, horizontal cuts were inserted to the plane during flattening in order to preserve area and facilitate knitting. Cuts in this direction allow knitting to be carried out in the normal ways, course by course while the shape of the flattened area was achieved by partial knitting technique. When horizontal cuts were not effective in area preservation during flattening due to geometric constraint, vertical cuts were inserted to make up its deficiency. However, if there was a vertical cut or a vertical hole on the plane, successive loop formation was not feasible and the fabric became discontinuous resulting in a gap. To correct it, the plane with a vertical cut was separated from the corner of the cut to the opposite edge. The two planes were knitted separately and later joined together by linking.

The surface of the 3D egg-like shape used in this study was divided into two planes with horizontal cuts inserted to the plane on the edges. The two planes represented the two halves of the shape cutting longitudinally following the placement of the vertical cuts. Fig. 2 illustrates of one of the 2D planes. The two planes were then subject to the next step before knitting, loop alignment.

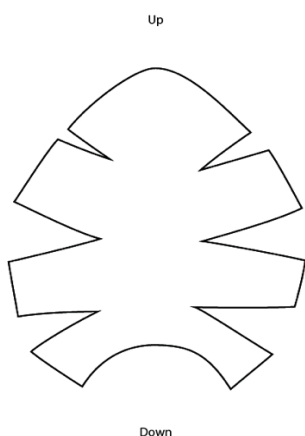

Fig. 2 An illustration of one of the 2D planes

### III. LOOP ALIGNMENT

In this section, two loop alignment methods are introduced. The loop alignment methods were based on the measurement taking method which determined how the dimensions of the plane were captured and the loops were aligned following the directions and the pathways of measurements. Before starting

loop alignment after measurement taking, an important step must be carried out, producing a reference fabric swatch. This swatch provided references for the loop density, given by courses per centimetre (cpc) and wales per centimetre (wpc). The cpc used in this study was 8.9286 cm while the wpc was 6.5617 cm. The corresponding loop length was 0.6088 cm. A knitting sequence can then be worked out according to the reference loop density.

To re-establish the 3D form of the shape, parameters such as length and width of the two planes were needed for calculating the number of courses and wales respectively. As the left and right side of each plane are non-identical given by the shape's geometry, measurements were taken separately. A vertical reference line was placed in the middle of each plane, intersecting the highest point of the top and that of the bottom arc, dividing the plane into two halves. The two planes, four halves, were subject to both loop alignment methods A and B.

In loop alignment method A, cartographic ideas were involved. Following the concept of parallels of latitude on the Earth, horizontal straight lines at 1 cm interval from the bottom as 0 cm up to the top are marked directly on the 3D shape as geodesics on the surface displayed in Fig. 3 [6]. The height of the plane was recorded. These horizontal straight lines on the 3D surface were directly traced onto the flattened 2D plane. The lines appeared as curved lines after flattening on the plane as shown in Fig. 4. Horizontal cuts with the open edges were also marked with individual 2D curved lines to indicate the height of the cuts on the reference line. The main concept of method A was to align knitting loops following the pathway of the 3D geodesic straight lines to re-establish the 3D form. The length of each 2D curved line was recorded and calculated in wales in the knitting sequence while the height of each curve on the plane along the vertical straight line was also marked down and counted in courses.

Loop alignment method B took measurements with a different approach. To measure the height of the plane, a vertical straight line was also drawn in the middle passing through the highest point of the top and that of the bottom curve. But 0 cm started from the lowest point of the whole plane instead of the top point of the bottom curve. A horizontal line was projected perpendicular to the vertical straight line to the lowest point of the plane, which referred to the lowest end point of the bottom curve, and set as 0 cm. In each centimetre interval, horizontal lines were projected to reach the outer edge of the plane up to the highest point on both left and right sides. After that, additional horizontal lines were marked on each corner point on the plane and their heights on the vertical reference line were recorded. The lengths of the 2D horizontal straight lines were converted to the number of wales to be knitted with the number of courses representing their heights. Method B directly captured the dimensional measurements on the 2D plane, neglecting the measurements from the 3D surface. Knitting loops were aligned following the perpendicular straight lines on the plane. Fig. 5 illustrates the plane with 2D straight lines using this method.

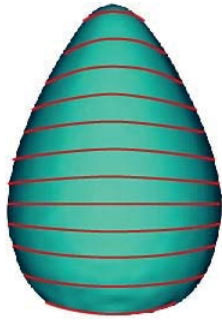

Fig. 3 An illustration of lines of geodesics of the 3D shape

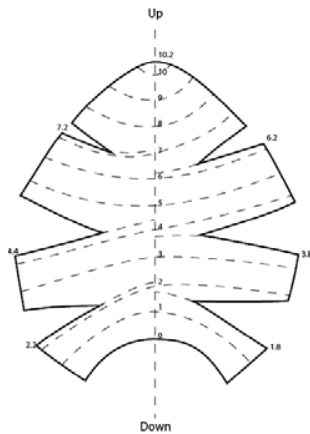

Fig. 4 An illustration of 2D curved lines from 3D straight lines after flattening in method A

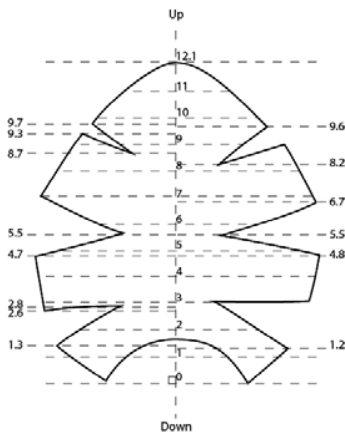

Fig. 5 An illustration of the flattened plane with 2D straight lines in method B

#### IV. KNITTING VALIDATION

Knitting sequences were determined for both methods and the knitting programmes of each were created in the Shima Seiki Knit system. The knitted fabrics of the two different halves for each method were knitted repeatedly three times, using SES-122S, to assure the experimental accuracy. Before knitting the experimental samples, a trial sample was carried out. A course of the trial fabric marking 100 wales was unravelled to measure the loop length, making sure the machine setting was correct. In method A, as the loops were

aligned along the open edge of the cuts, partial knitting was not applicable. The contours of the two planes were finished with only widening and narrowing knitting techniques. In method B, in order to join the two edges of each cut, partial knitting was applied. However, there was a technical limitation in partial knitting which led to a small error in area preservation. In the section of partial knitting, the start and the end of it shared the same total width which was the total number of needles. If they did not match, the last or last few loops will hang on the needle or it cannot knock over to form new course in the last knitting course. These cases will cause yarn breaking, missing loop or laddering on the edge or even needle damages. To correct the mismatching situation on the open edge such as 1.2 cm and 3 cm on the right side in Fig. 5, the width of the two courses were levelled by 1 or 2 loops. The finished fabrics were linked together for each two different halves to complete the 3D shape and were finalised with the fabric finishing processes.

#### V. RESULT EVALUATION

Six samples in total, three for each method, were produced for assessment of their 3D shape accuracy. By evaluating the visual appearance of the 3D knitted shape as a qualitative approach and counting the loop density of it as a quantitative approach, the shapes from the two loop alignment methods were assessed by their ability to reconstruct the target dimensions. The knitted shapes were put onto the target object for shape comparison. A 3D knitted shape with accurate dimensions should not have excessive or inadequate fabrics when put onto the target object. Excessive fabric will appear as folds or bumps while inadequate fabric will be evident by stretch fabric or elongated loops. In the qualitative evaluation, extra folds and bumps were easy to see, fabric stretch or elongated loops were not as obvious and became more difficult to judge. Quantitative analysis by measuring the loop density, cpc and wpc, was, therefore, an objective way to determine distortion in shape induced by stretched and elongated loops. To ensure correct knitting, the loop density of the knitted shape was set to a tolerance of  $\pm 5\%$  comparing with the reference fabric swatch.

Three repeated knitted shapes by method A in which loops aligned on the plane following the 3D straight lines, were evaluated one by one. Fig. 6 shows images of one of the shapes by method A put onto the target object. It is obvious that the shape is totally different from the target object from front view. There are two protrusions on the sides and the side edges are not smooth as the target. From the side view, the linking seam is wavy and the surrounding fabric is crimped. The crimping seams are apparently caused by the excessive length. Observing the centre front loops reveals that those fabrics below the bulging part of the target shape are less dense than those in the area 1 cm below the tip. This implies that the area between the bulging part and the bottom does not have sufficient fabric as loops are under stretch. The qualitative evaluation shows that the 3D knitted shape by method A has severe distortions. Method A cannot preserve the target geometrical dimensions.

The appearances of the 3D knitted shapes by method B put onto the target object were also reviewed, showing in Fig. 7. The surface and the edges of the shape viewing from the front are relatively much smoother, but there are several small knots lying in lines on the surface. These small knots are the partial knitting marks. The side seam from the side view is relatively straight. The size of the loops is more even visually. No obvious bumps or stretch is found on the shape. Therefore, the 3D shapes from method B are likely to be more accurate according to the qualitative evaluation.

From the above qualitative evaluation, method A is already proven not able to reconstruct the target dimensions. By measuring the loop density of the knitted shapes as a quantitative analysis, an assessment can be made of how well is the shape reconstruction. Three random regions of each shape, both from method A and B, put onto the target object were measured. Both shapes were also measured at the relaxed state. The loop density in relaxed state as shown in Table I for method A and Table II for method B are within the tolerance,  $\pm 5\%$ , showing that the knitting process is not the factor to the shaping inaccuracy if any.

The loop densities of the shapes by method A on the object in Table I are mostly unsatisfactory. All wpc percentage differences are more than  $-5\%$  though a few cpc percentage differences are within  $\pm 5\%$ . And the wpc and cpc total percentage difference average are  $-10.31\%$  and  $-6.55\%$  respectively, exceeding the tolerance. Therefore, from the qualitative and quantitative evaluations, it can be said that the 3D knitted shape by method A is distorted. The 3D of the shape is not preserved.

For the 3D knitted shape by method B, the loop density result, all readings are within the tolerance,  $\pm 5\%$ . The total average of loop density percentage difference of wpc is  $-2.64\%$  and cpc is  $0.95\%$ . The 3D knitted shapes by method B is proven by both qualitative and quantitative evaluation that they are accurately preserving the 3D form of the target object. Therefore, the loop alignment method B is feasible.

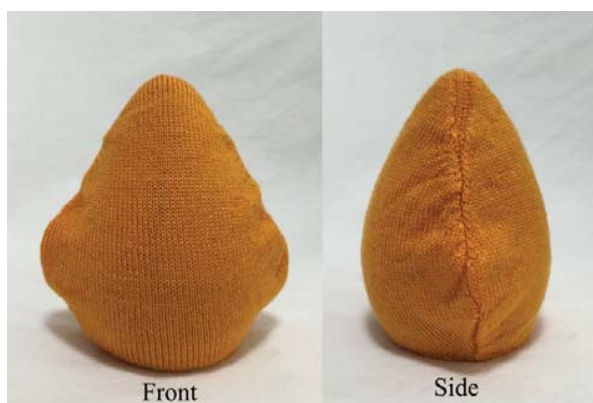

Fig. 6 The front and side view of the 3D knitted shape by method A

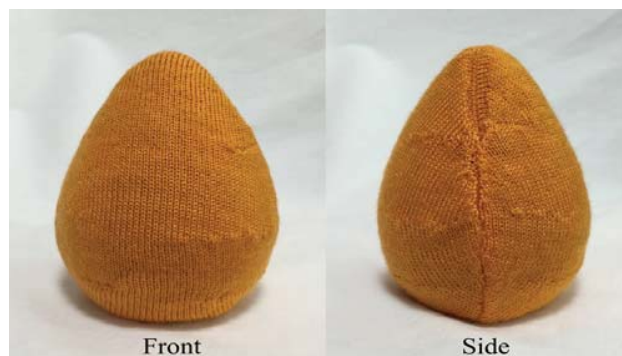

Fig. 7 The front and side view of the 3D knitted shape by method B

TABLE I  
LOOP DENSITY OF 3D KNITTED SHAPE BY METHOD A

Item and Area	wpc	% diff	cpc	% diff
Working loop density	6.5617		8.9286	
Relax	6.451612	-1.68%	8.695652	-2.61%
Positive Gaussian Curvature A I	6.106870	-6.93%	8.196721	-8.20%
On object	5.358142	-18.36%	8.108108	-9.19%
On object	6.153846	-6.22%	8.450704	-5.35%
Average on object	5.872619	-10.50%	8.251844	-7.58%
Relax	6.451612	-1.68%	8.829557	-0.89%
Positive Gaussian Curvature A II	5.797101	-11.65%	8.196721	-8.20%
On object	5.357142	-18.36%	8.333333	-6.67%
On object	6.185567	-5.73%	8.955223	0.30%
Average on object	5.779937	-11.91%	8.495092	-4.86%
Relax	6.557377	-0.07%	8.771929	-1.75%
Positive Gaussian Curvature A III	5.970149	-9.02%	8.695652	-2.61%
On object	6.153846	-6.22%	7.547058	-14.35%
On object	5.882352	-10.35%	8.510638	-4.68%
Average on object	6.002116	-8.53%	8.284449	-7.21%
Total Average on object	5.884891	-10.31%	8.343795	-6.55%

TABLE II  
LOOP DENSITY OF 3D KNITTED SHAPE BY METHOD B

Item and Area	wpc	% diff	cpc	% diff
Working loop density	6.5617		8.9286	
Relax	6.666667	1.60%	9.259259	3.70%
Positive Gaussian Curvature B I	6.315789	-3.75%	9.090909	1.82%
On object	6.349206	-3.24%	9.206349	3.11%
On object	6.4	-2.46%	9.090909	1.82%
Average on object	6.354999	-3.15%	9.129389	2.25%
Relax	6.611570	0.76%	9.090909	1.82%
Positive Gaussian Curvature B II	6.25	-4.25%	8.928571	0.00%
On object	6.4	-2.46%	9.206349	3.11%
On object	6.451613	-1.68%	8.988764	0.67%
Average on object	6.367204	-2.96%	9.041228	1.26%
Relax	6.666667	1.60%	9.259259	3.70%
Positive Gaussian Curvature B III	6.558377	-0.07%	8.860759	-0.76%
On object	6.217391	-0.61%	8.823529	-1.18%
On object	6.25	-4.75%	8.928571	0.00%
Average on object	6.443039	-1.81%	8.870953	-0.65%
Total Average on object	6.388414	-2.64%	9.013857	0.95%

## VI. DISCUSSION

From the experiments, it shows that loop alignment method B can successfully preserve the shape dimensions while loop alignment method A fails. In other words, loops aligning following the 3D geodesics of a positive Gaussian curvature surface cannot resume the 3D from the area-preserving plane. Ng and Yu, in 2006, had introduced a method to calculate the distance distortion by using HYBRID-SUM with flexible fabrics [2]. It was reported that if cutting a shape longitudinally, the length of the edges from front view differed after direct flattening. As flatbed knitting is a 2D knitting mechanism, the 2D curved lines are executed in straight lines while keeping their lengths. The length and contour of the outer edges of the shape are distorted as the 2D curved lines are forced to be 2D straight lines. Fig. 8 shows an illustration of half of the shape developed by method A. Loops aligning with this method gives a flat plane, losing the original 3D. The lengthened edges are forced to fit the original side seams, leading to the wavy and creased seams after linking. The 3D shape does not possess the required 3D.

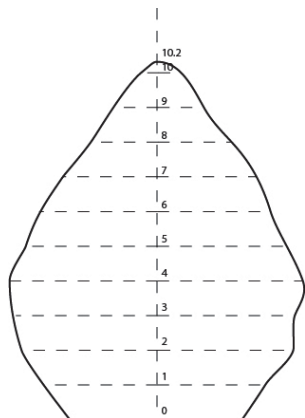

Fig. 8 An illustration of the actual shape of one of knitted fabric by method A

The results in Table I show that stretching appears in many regions of the shape, implying inadequate amount of fabric. If this is the case, however, the result of this is seemingly not coherent with the qualitative analysis that the quantitative analysis shows there are missing loops in many regions while the qualitative analysis points out that there are bumps and wavy seams induced by excess fabrics. In fact, both cases can be mutually existing. As wpc is counting the number of wales along a course across the width of the shape, the stretching loops in the centre front or back are easily to be involved, and thus affecting the wpc values. For cpc, if the measurement is taken at a wale in the area of the bumps which is hanging away from the target object and staying relaxed, the reading should be more or less similar to the loop density of the shape in relax state. Therefore, the shape from method A is missing loops in the centre and has excess loops on both sides. Meanwhile, it is concluded that the qualitative evaluation is insufficient for measuring missing loops while the quantitative evaluation is insufficient for measuring excess fabrics.

Loop alignment method B is successful as loops align in the same direction which is in accordance with the 2D knitting mechanism. This knitting method allows 2D knitting to retrieve the 3D surface from a flattened plane.

## VII. CONCLUSION

These two loop alignment methods have clearly stated how the 3D surface with positive Gaussian curvature is preserved in 3D shape knitting and the relations between loop alignment and 3D knitted shapes. Loop alignment method B following the 2D straight lines on the 2D flattened plane successfully retrieves the 3D surface while loop alignment method A following the 3D straight geodesics on the 3D surface fails to preserve the target dimensions. It is also known that both qualitative and quantitative evaluations are crucial to measure the shape accuracy as each of them tackles different shape distortion conditions. After all, this study on knitting loops manipulating a 3D surface with positive Gaussian curvature is feasible.

## ACKNOWLEDGMENT

This study is funded by The Innovation and Technology Fund of the Government of Hong Kong SAR, approved by The Institute of Textiles and Clothing of The Hong Kong Polytechnic University with the project reference number ITP/027/13TI. The authors would like to take this opportunity to express our gratitude to the research funding and department.

## REFERENCES

- [1] Yanxue, M. & Lamar, T. A. M. Three-dimensional shaping for knitted garments. *Research Journal of Textile and Apparel* 2013; 17 (3): 128-139.
- [2] Yang S, Mao L. Application of returning knit in woollen sweater design. *Wool Textile Journal* 2009; 37(1):44-48.
- [3] Benitez J, Thome N. Application of differential geometry to cartography. *International Journal of Mathematical Education in Science and Technology* 2004; 35(1):20-38.
- [4] Ng R, Yu W. Distortion Theory of Stereographic Draping with Flexible Fabric on Surface of Constant Curvature. *Sen'i Gakkaishi* 2006; 62(5):67-73.
- [5] Atchison S A *Mathematical History of Cartography*. Taxes: Texas A&M University; 2011.
- [6] Polking, J. C. & (2000). *Mapping the Sphere*. Retrieved January 23, 2015 from Rice University, Department of Mathematics Web site: <http://math.rice.edu/~polking/cartography/cart.pdf>

**Cheung C. T.** graduated from the Institute of Textiles and Clothing, the Hong Kong Polytechnic University, Hong Kong SAR, in 2012, specialized in knitwear design and technology. She is currently a research student in the same department.

**Ng R. K. P.** graduated from the California Institute of Technology, Pasadena, USA with B.Sc. and was awarded a PhD by the Hong Kong Polytechnic University. He is a Fellow of the Hong Kong Institute of Textile and Apparel. His research interest is 3-D surface unfolding and the related aesthetics.

**Lo T. Y.** has an MPhil in fibre science from Bradford University, UK, and a PhD in knitting technology awarded by the CNAA, UK. Research interest is mainly in knitting technology and materials.

**Zhou jinyun** graduated from JiangNan University specialized in textile technology and was awarded a PhD by the Hong Kong Polytechnic University. Research interest is mainly in digital knitting technology.