

# Stress Analysis of Water Wall Tubes of a Coal-fired Boiler during Soot Blowing Operation

Pratch Kittipongpattana, Thongchai Fongsamootr

**Abstract**—This research aimed to study the influences of a soot blowing operation and geometrical variables to the stress characteristic of water wall tubes located in soot blowing areas which caused the boilers of Mae Moh power plant to lose their generation hour. The research method is divided into 2 parts (a) measuring the strain on water wall tubes by using 3-element rosette strain gages orientation during a full capacity plant operation and in periods of soot blowing operations (b) creating a finite element model in order to calculate stresses on tubes and validating the model by using experimental data in a steady state plant operation. Then, the geometrical variables in the model were changed to study stresses on the tubes. The results revealed that the stress was not affected by the soot blowing process and the finite element model gave the results 1.24% errors from the experiment. The geometrical variables influenced the stress, with the most optimum tubes design in this research reduced the average stress from the present design 31.28%.

**Keywords**—Boiler water wall tube, Finite element, Stress analysis, Strain gage rosette.

## I. INTRODUCTION

FATIGUE is one of the top causes of failures which make coal-fired boilers lost their generation in various locations [1]. One of the most highly impacted locations at Mae Moh power plant was at the soot blower wall box, which had lost up to 500,000 Megawatt-hours in the last 10 years and cost 33 million USD in selling opportunity.

During the combustion process, clinkers were created and accumulated on the water wall tubes, making the efficiency of the boiler dropped as a consequence. Hence, the soot blowers were installed in order to remove them by injecting superheated steams. However, since the steam temperature was lower the flue gas temperature, this situation led to a failure hypothesis which states that soot blowing operations induced the cyclic temperature because they changed the ambient temperature around the tubes and caused fatigue to occur [2], [3]. To install soot blowers, some water wall tubes were bent and welded with steel plates to create boxes called “soot blower wall boxes”. However, after several years in operation, cracks started to form at the fin tips of tube membranes as shown in Fig. 1. In addition, the microscopic examination of the crack found that the crack was from corrosion-fatigue as shown in Fig. 2. The design of the soot blower wall boxes has been improved in the last 10 years to

P. Kittipongpattana is with Department of Mechanical Engineering, Chiang Mai University, Chiangmai, Thailand (corresponding author to provide phone: +66-54-3231; fax: +66-54-3238; e-mail: pratch\_k@cmu.ac.th, pratch.k@egat.co.th).

T. Fongsamootr, is with Department of Mechanical Engineering Chiang Mai University, Chiangmai, Thailand.

reduce stress at the fin tips for extending their lifetime but there is no published study about how geometries affect the stress in each design.



Fig. 1 Cracks at fin tip of tubes membrane

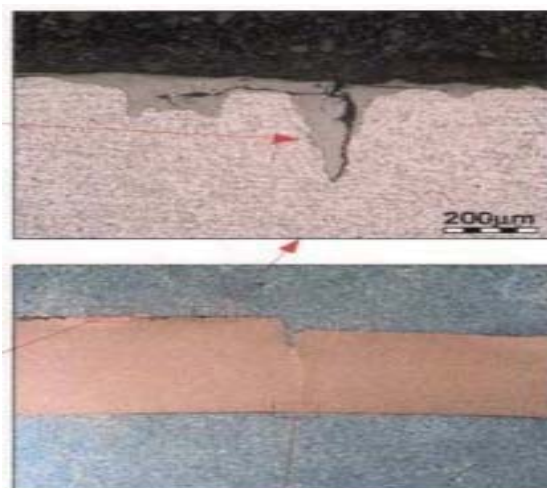

Fig. 2 Microscopic examination of the crack

## II. METHOD

A finite element analysis (FEA) is generally used in complex problems in order to obtain a solution. To analyze the stress in a boiler tube problem, heat transfers equations are used to solve a temperature profile on the tubes by using design and operating data. Although the simulation can be validated using various methods, one of the most practical methods is using strain gages to obtain data for validation [4], [5]. Hence, the finite element simulation and strain

measurement were chosen as the main methods for this research to study the effect from soot blowing process and geometrical variables.

#### A. Strain Measurement

A strain gage rosette is very practical tool in experimental stress analysis, especially when principal stress direction is unknown [6]. Strain gages were installed at a fin tip for measuring the strain by using 45°-rectangular rosette orientation as shown in Fig. 3 and evaluated principal stress and equivalent stress by (1) and (2) respectively. The strains were obtained in two conditions. Firstly, during operating the plant at full capacity, the strains were collected for 65 hours for finding the equivalent stress. Secondly, the strains were obtained during soot blowing operations which lasted about 900 milliseconds to understand the stress behavior during the cleaning process.

$$\sigma_{p,q} = \frac{E}{2} \left( \frac{\epsilon_1 + \epsilon_2}{1-\nu} \right) \pm \frac{1}{1+\nu} \sqrt{2 \{ (\epsilon_1 - \epsilon_3)^2 + (\epsilon_2 - \epsilon_3)^2 \}} \quad (1)$$

$$\sigma' = \sqrt{(\sigma_p^2 - \sigma_p \sigma_q + \sigma_q^2)} \quad (2)$$



Fig. 3 Strain gage installation on boiler tubes

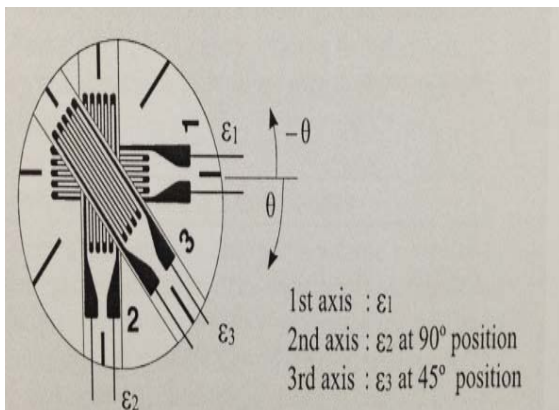

Fig. 4 Strain gages in 45°-rectangular rosette orientation

Since the strain is measured at a high temperature, the obtained data will deviate from the actual and could be corrected by (3) and (4). It is necessary to measure the

material temperature to compensate the measurement hence type-K thermocouples were used in the experiment for measuring the tube surface temperature and ambient temperature inside the boiler 10 mm from the fireside surface [7].

$$\epsilon_{actual} = \left( \epsilon_m \times \frac{2}{Kc20} - \epsilon_{app} \right) \times \frac{1}{\{1 + (T - RT) \times Ck \times 10^{-6}\}} \quad (3)$$

$$\epsilon_{app} = a + b \cdot T + c \cdot T^2 + d \cdot T^3 + e \cdot T^4 + f(T - RT) \times MI \quad (4)$$

where  $\sigma_p$  and  $\sigma_q$  are principal stress (N/m<sup>2</sup>), E is young's modulus (N/m<sup>2</sup>),  $\epsilon_1$ ,  $\epsilon_2$ , and  $\epsilon_3$  are actual strains from the strain gages at positions 1-3 (μm/m), respectively, as shown in Fig. 4,  $\nu$  is Poisson's ratio,  $\sigma'$  is the equivalent stress,  $\epsilon_{actual}$  is the actual strain (μm/m),  $\epsilon_{app}$  is thermal output corrected strain (μm/m), a-e are the coefficients of quartic expressions of thermal outputs, f is the coefficient of heating influence of the MI cable, Kc20 is the gage factor, T is the tube temperature, RT is the room temperature (°C), Ck is the sensitivity shift on temperature (ppm/°C), and MI is the heated length of the MI cable (m).

#### B. Finite Element Model

A soot blower wall box was created as a finite element model and used for evaluating equivalent stress at the fin tips in 6 locations as shown in Fig. 5. Heat transfer coefficients were input in the model by using operating data. Moreover, mechanical boundary conditions were input from measure data and design parameters as shown in Fig. 6 [5], [8]. The model was created by using the dimensions from the design which were then validated by verifying equivalent stress with experimental data.



Fig. 5 Location of evaluated equivalent stress on a model

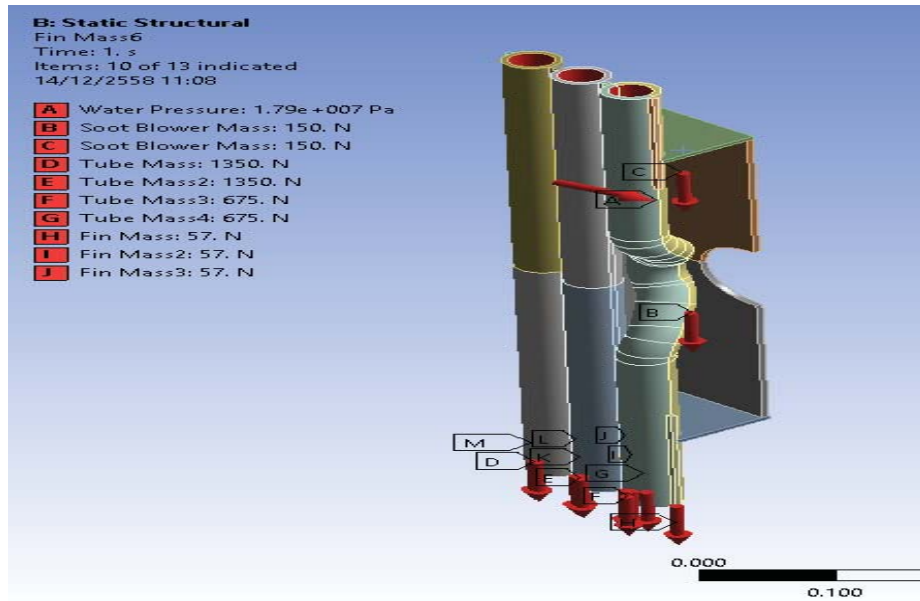

Fig. 6 Boundary condition in the model

### C. Study of Geometrical Variables

Fig. 7 shows the selected key variables, for instance the tube thickness, the box length, and the fin gap. The tube thickness would be changed from 0.18 to 0.22 inches. Secondly, the box length was changed from 610 mm to 800 mm. Finally, the fin gap would be studied in the range between 560 mm and 320 mm.

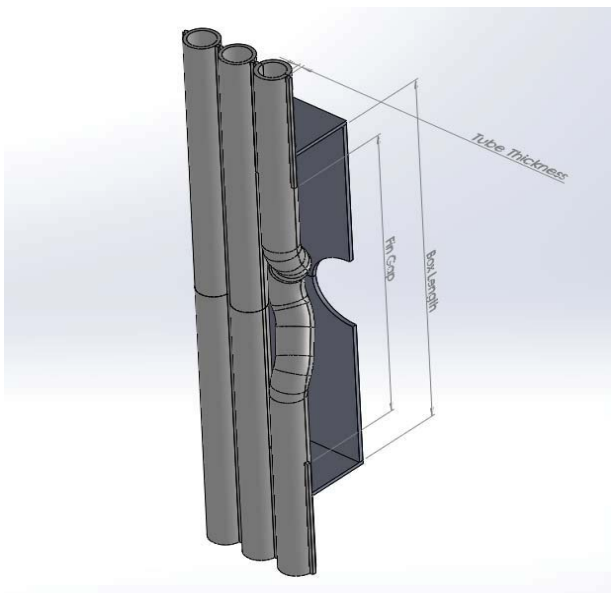

Fig. 7 Geometrical variables were selected to studied

## III. RESULTS

### A. Effect of Soot Blowing Operations

The results revealed that soot blowing process had no influence on the stress at the tube. Fig. 8 (a) shows how equivalent stress and ambient temperature changed in period

of a soot blowing operation, finding illustrating that the stress had no significant change in this period even though the temperature was increased after 90 seconds of the operation. It is expected that this was a result of accumulated clinkers on the wall tubes being eliminated after the cleaning process was done so it made the temperature increased after the process. The next experiment was studied in a case that there was no clinker on the tubes. The steam was injected again and it was found that the stress and ambient temperature were not influenced by the cleaning process as shown in Fig. 8 (b).

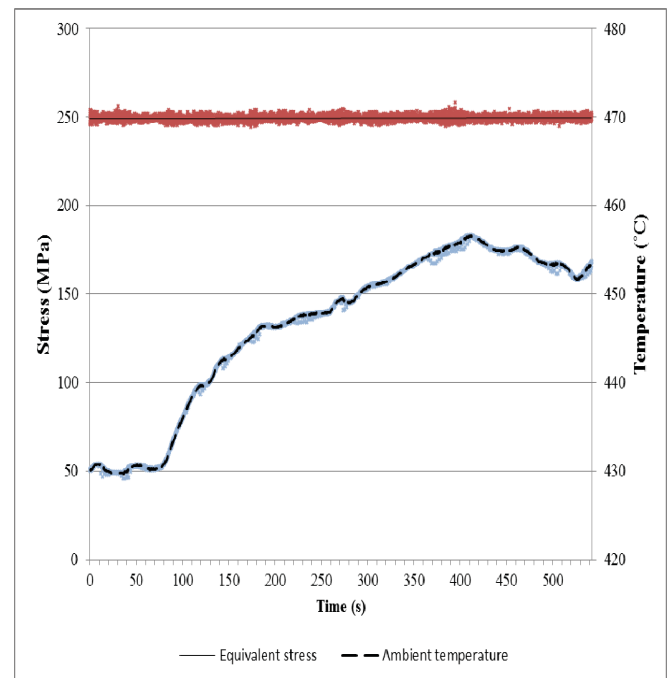

(a)

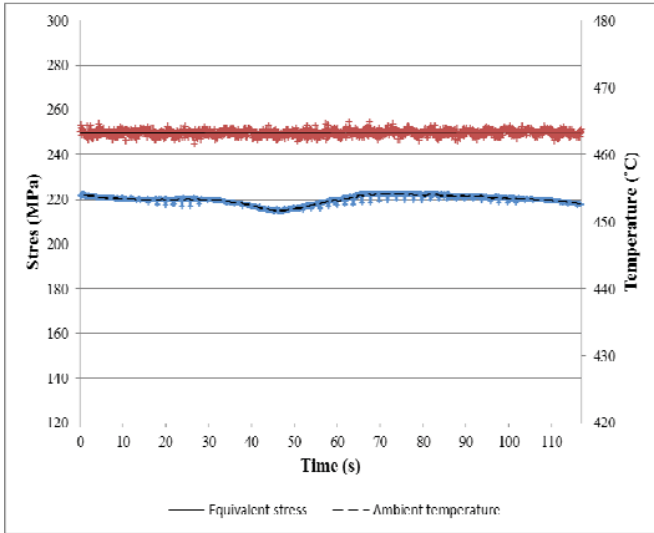

(b)

Fig. 8 Stress and ambient temperature during the soot blowing periods when (a) there was clinker on tubes (b) no clinker

**B. Validation**

The result from the finite element simulation indicated that the maximum stress was found on the fin tip as shown in Fig. 9 which was at the same location as the cracks and Fig. 10 shows the actual stress obtained from strain gages during 66 hours, and the average stress evaluated from (1) was 241 MPa. The finite element model gave a stress of 238 MPa as shown in Fig. 11 which was 1.24% different from the experimental data, hence this simulation was acceptable [9].

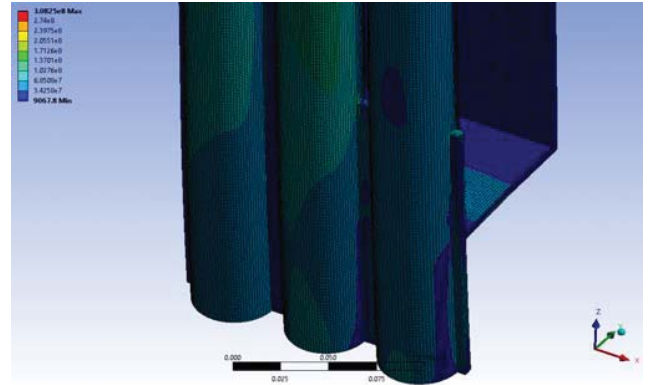

Fig. 9 Result from finite element simulation

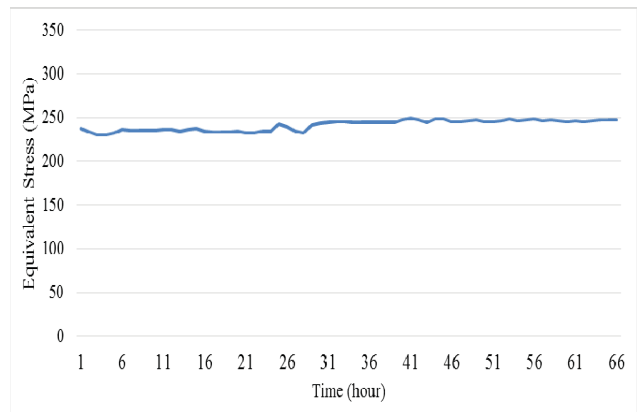

Fig. 10 Equivalent stress during operation at full capacity

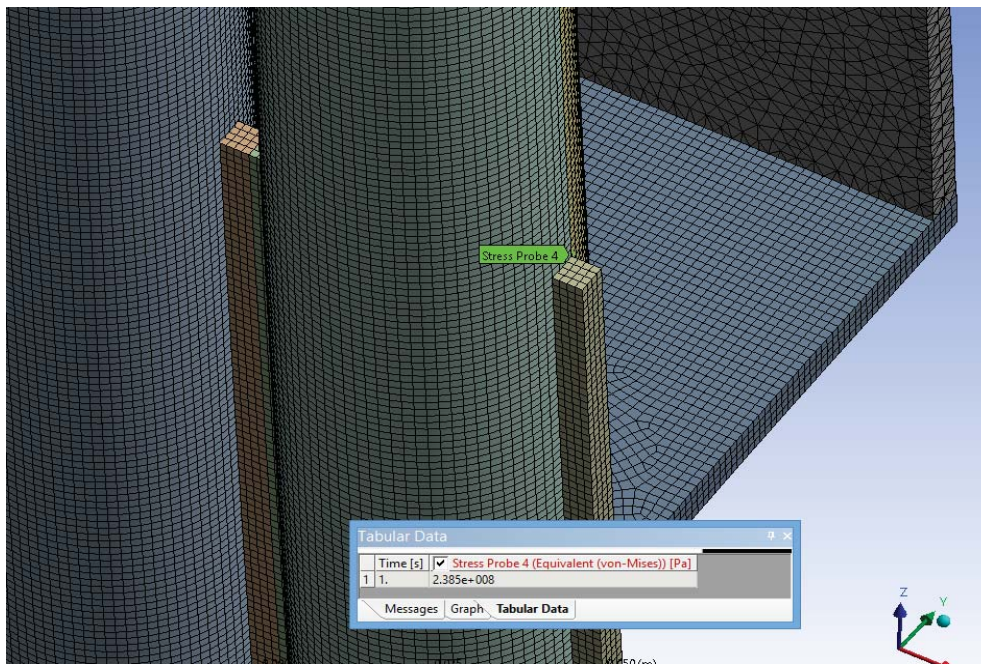

Fig. 11 Stress in the simulation at same location as experiment

C. Geometrical Model

Fig. 12 shows the relationship between tube thickness and average stress, which indicates that the stress can be reduced by increasing the tube thickness. When the box was lengthened, the stress was decreased as shown in Fig. 13 in which the length that made the lowest stress was 610 mm. To compare with the present design (700mm box length and 560 fin gap), the model with 610 mm and 700 mm were selected to vary fin gaps. The result is that the recommended design was a box of 610 mm in length with a 560 mm fin gap, which yielded the lowest stress on the tube as shown in Fig. 14 and could reduce the stress from the present design by 31.28% as shown in Fig. 15.

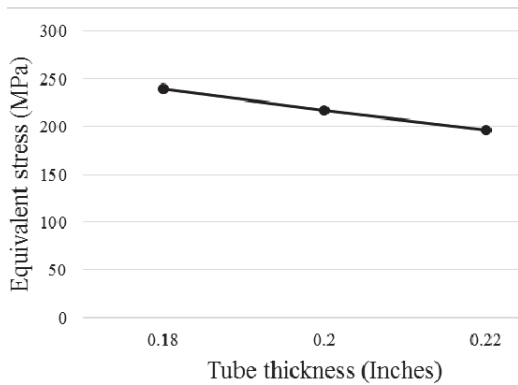

Fig. 12 Relationship between tube thickness and equivalent stress

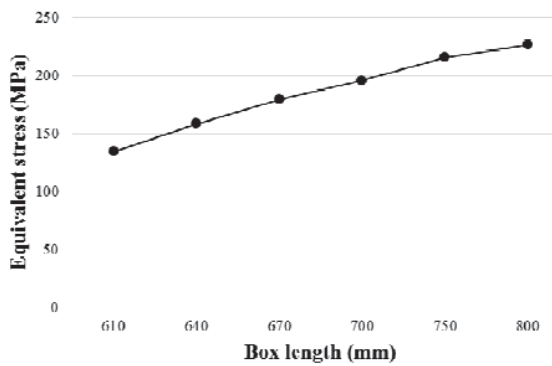

Fig. 13 Relationship between box length and equivalent stress

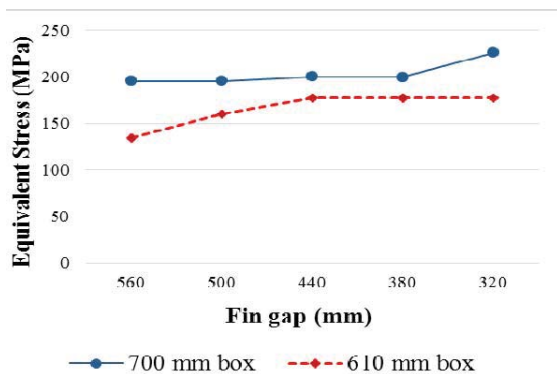

Fig. 14 Relationship between fin gap and equivalent stress

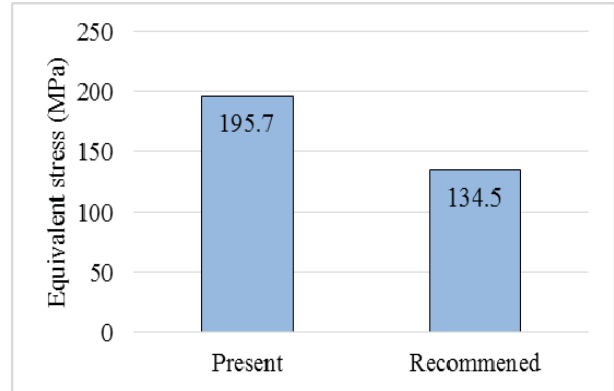

Fig. 15 Comparison of equivalent stress between two designs

IV. CONCLUSION

The soot blowing operation has no effect on the stress at water wall tubes. From the result, however, the microscopic examination showed that the crack was created from fatigue hence the stress should be analyzed in periods of cyclic operations, for example, in a start-up or shut-down period. The model gave acceptable results in which the lowest stress model has 31.28% stress lower than the present design so it can extend the tubes life time by changing the design of geometry.

ACKNOWLEDGMENT

This research is supported by EGAT-CMU scholar program of Electricity Generating Authority of Thailand (EGAT) and Chiang Mai University (CMU).

REFERENCES

- [1] M. M. Rahman, J. Purbolaksono, and J. Ahmad, "Root cause failure analysis of a division wall superheater tube of a coal-fired power station", *Engineering Failure Analysis*, vol. 17, p. 1490-4, May 2010.
- [2] J.H. Moon, and T.K. Ha, "Thermal fatigue behavior of austenitic stainless steels", World Academy of Science Engineering and Technology, *International Journal of Chemical, Molecular, Nuclear, Materials and Metallurgical Engineering*. vol:8, No:5, p. 394-7, 2014.
- [3] R. Viswanathan, "Damage and life assessment of high temperature components". ASM International, Metals Park, Ohio, 1995.
- [4] M. Botha, and M. P. Hindley, "One-way fluid structure interaction modelling methodology for boiler tube fatigue failure", *Engineering Failure Analysis*, vol.48, p. 1-10, 2015.
- [5] C. Nakvaree, "Fatigue analysis of furnace corner waterwall tube of boiler in Mae Moh thermal power plant engineering thermodynamics", Chaingmai, Chiang Mai University, 2003.
- [6] Vishay Precision Group, "Strain gage rosettes: selection, application and data reduction", *Strain gages and instruments*, TN-515, p.151-62, 2010.
- [7] Tokyo Sokki Kenkyojo co, Ltd., "Operation manual TML weldable high temperature strain gauge AWH", unpublised.
- [8] R. Caligiuri, J. Foulds, R. Sire, and S. Andrew, "Thermal constraint considerations in design of a heat recovery boiler", *Engineering Failure Analysis*, vol.13, p.1388-96, 2006.
- [9] N.H. Kim, C.S. Oh, and Y.J. Kim, "A method to predict failure pressures of steam generator tubes with multiple through-wall cracks", *Engineering Fracture Mechanics*, vol. 77, p.842-55, 2010.