

Implementation of MPPT Algorithm for Grid Connected PV Module with IC and P&O Method

Arvind Kumar, Manoj Kumar, Dattatraya H. Nagaraj, Amanpreet Singh, Jayanthi Prattapati

Abstract—In recent years, the use of renewable energy resources instead of pollutant fossil fuels and other forms has increased. Photovoltaic generation is becoming increasingly important as a renewable resource since it does not cause in fuel costs, pollution, maintenance, and emitting noise compared with other alternatives used in power applications. In this paper, Perturb and Observe and Incremental Conductance methods are used to improve energy conversion efficiency under different environmental conditions. PI controllers are used to control easily DC-link voltage, active and reactive currents. The whole system is simulated under standard climatic conditions (1000 W/m^2 , 25°C) in MATLAB and the irradiance is varied from 1000 W/m^2 to 300 W/m^2 . The use of PI controller makes it easy to directly control the power of the grid connected PV system. Finally the validity of the system will be verified through the simulations in MATLAB/Simulink environment.

Keywords—Incremental conductance algorithm, modeling of PV panel, perturb and observe algorithm, photovoltaic system and simulation results.

I. INTRODUCTION

THE roots of PV energy grew out of experiments done over 150 years ago by the French physicist Antoine Cesar Becquerel in 1839. He observed that he could produce an electric current by shining light on an electrolytic cell composed on an electrolyte and two electrodes. The German scientist Heinrich Hertz and other observed the PV effect – the conversion of light into electricity – in solids during the 1870s, and the first primitive PV cells were built in the 1800s, with about 1-2% efficiencies [1].

PV systems are like any other electrical power generating systems; just the equipment used is different than that used for conventional electromechanical generating systems. However, the principles of operation and interfacing with other electrical systems remain the same, and are guided by a well-established body of electrical codes and standards.

Although a PV array produces power when exposed to sunlight, a number of other components are required to

properly conduct, control, convert, distribute, and store the energy produced by the array [3].

Depending on the functional and operational requirements of the system, the specific components required may include major components such as a DC-AC power inverter, battery bank, auxiliary energy sources and sometimes the specified electrical load (appliances). In addition, an assortment of balance of system (BOS) hardware, including wiring, over current surge protection and disconnect devices, and other power processing equipment.

Since the efficiency of a solar cell is very low. In order to increase the efficiency, methods are to be undertaken to match the source and load properly. One such method is the Maximum Power Point Tracking (MPPT) [4]. It is algorithm that included in charge controllers used for tracking maximum available power from PV module under certain conditions. The charge controller looks at the output of the panels and compares it to the battery voltage. It then figures out what is the best power that the panel can put out to charge the battery. The voltage at which PV module can produce maximum power is called ‘maximum power point’ or ‘peak power voltage’.

MPPT is not a mechanical tracking system that “physically moves” the modules to make them point more directly at the sun. MPPT is a fully electronic system that varies the electrical operating point of the modules so that the modules are able to deliver maximum available power. MPPT can be used in conjunction with a mechanical tracking system, but the two systems are completely different. Most modern MPPT's are around 93-97% efficient in the conversion [7]. The maximum power depends upon following factors:

- (a) Solar radiation
- (b) Solar cell temperature
- (c) Ambient temperature

II. PERTURB AND OBSERVE METHOD

The concept behind the "perturb and observe" (P&O) method is to modify the operating voltage or current of the photovoltaic panel until you obtain maximum power from it. For example, if increasing the voltage to a panel increases the power output of the panel, the system continues increasing the operating voltage until the power output begins to decrease. Once this happens, the voltage is decreased to get back towards the maximum power point. This perturbation continues indefinitely. Thus, the power output value oscillates around a maximum power point and never stabilizes [9]. In this method, the sign of the last perturbation and the sign of the last increment in the power are used to decide what the

Arvind Kumar is with the National Institute of Technology Goa, Ponda-403401, Goa, India (Corresponding Author: phone: +919405330439; e-mail: arvind20022008@gmail.com).

Manoj Kumar is with the National Institute of Technology Goa, India (phone: +918275621660; e-mail: pooniamanoj27@gmail.com).

Dattatraya H. Nagaraj is with the National Institute of Technology Goa, India (Ph: +918806021531; e-mail: geniusdattu@gmail.com).

Amanpreet Singh is with the National Institute of Technology Goa, India (Ph: +919405116836; e-mail: amanpreet_singh75@gmail.com).

Ms. JayanthiPrattapati is with the department of Electrical and Electronics Engineering, National Institute of Technology Goa, Ponda-403401, Goa, India (phone: +919049544397; e-mail: jayanthip@nitgoa.ac.in).

next perturbation should be. As can be seen in Fig. 1, on the left of the MPP incrementing the voltage increases the power whereas on the right decrementing the voltage increases the power.

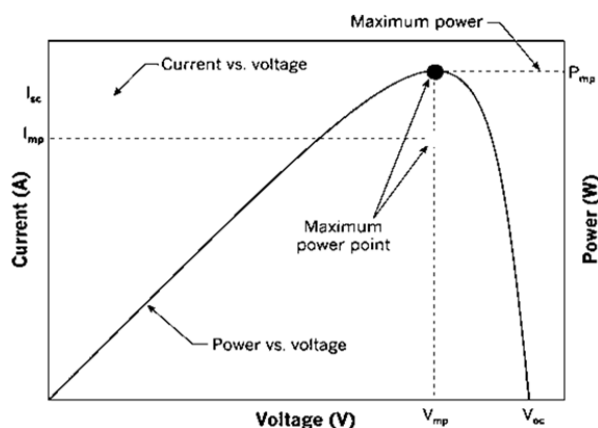

Fig. 1 PV panel characteristics curves

If there is an increment in the power, the perturbation should be kept in the same direction and if the power decreases, then the next perturbation should be in the opposite direction. Based on these facts, the algorithm is implemented [2]. The process is repeated until the MPP is reached. Then the operating point oscillates around the MPP.

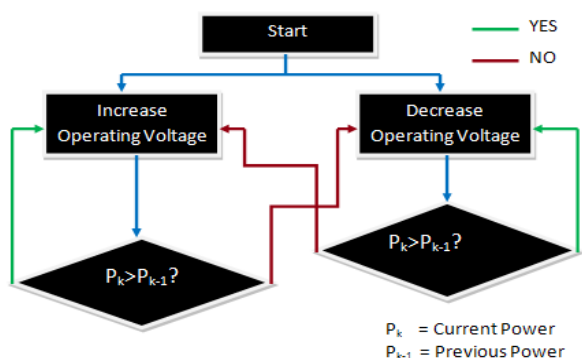

Fig. 2 Flow chart of Perturb & Observation method

The major drawbacks of the P&O method are that the power obtained oscillates around the maximum power point in steady state operation, it can track in the wrong direction under rapidly varying irradiance levels and load levels, and the step size (the magnitude of the change in the operating voltage) determines both the speed of convergence to the MPP and the range of oscillation around the MPP at steady state operation [4]-[8].

III. INCREMENTAL CONDUCTANCE METHOD

This method uses the PV array's incremental conductance dI/dV to compute the sign of dP/dV . When dI/dV is equal and opposite to the value of I/V (where $dP/dV=0$) the algorithm knows that the maximum power point is reached and thus it terminates and returns the corresponding value of operating voltage for MPP. This method tracks rapidly changing

irradiation conditions more accurately than P&O method. One complexity in this method is that it requires many sensors to operate and hence is economically less effective [5], [6].

We know that:

$$P = V * I \quad (1)$$

Differentiating w.r.t voltage yields;

$$\frac{dP}{dV} = \frac{d(V*I)}{dV} \quad (2)$$

$$\frac{dP}{dV} = I * \left(\frac{dV}{dV}\right) + V * \frac{dI}{dV} \quad (3)$$

$$\frac{dP}{dV} = I + V * \frac{dI}{dV} \quad (4)$$

When the maximum power point is reached the slope $dP/dV=0$. Thus the condition would be:

$$\frac{dP}{dV} = 0 \quad (5)$$

$$I + V * \frac{dI}{dV} = 0 \quad (6)$$

$$\frac{dI}{dV} = -\frac{I}{V} \quad (7)$$

The basic algorithm of IC is shown in Fig. 3

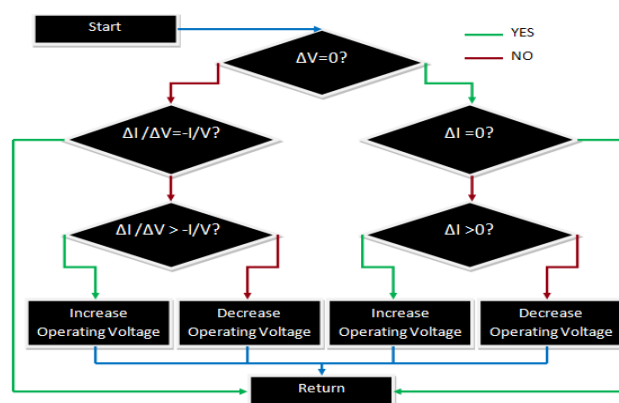

Fig. 3 Flow Chart of Incremental Conductance Method

The drawbacks of these techniques are mainly two. The first and main one is that they can easily lose track of the MPP if the irradiation changes rapidly [6]. In case of step changes they track the MPP very well, because the change is instantaneous and the curve does not keep on changing. However, when the irradiation changes following a slope, the curve in which the algorithms are based changes continuously with the irradiation, so the changes in the voltage and current are not only due to the perturbation of the voltage. As a consequence it is not possible for the algorithms to determine whether the change in the power is due to its own voltage increment or due to the change in the irradiation.

IV. SIMULATIONS AND RESULTS

A. Module Data Sheet and Characteristics

The photovoltaic module used in the simulation of grid connected PV module with IC and P&O as MPPT algorithm in sections B and C is Canadian Solar CS5P-220M. Table I contains specifications for one module.

| Parameter | Value |
|-----------------------------------|-----------|
| Number of series-connected cells | 96 |
| Open-circuit voltage V_{oc} | 59.2618 V |
| Short-circuit current I_{sc} | 5.09261 A |
| Voltage at maximum power V_{mp} | 48.3159 V |
| Current at maximum power I_{mp} | 4.54758 A |

1. I-V and P-V Characteristics of One Module at 25°C

The photovoltaic module Canadian Solar CS5P-220M is simulated for different values of irradiance (kW/m^2). Fig. 4 shows I-V and P-V characteristics of the module for different values of irradiance at constant temperature (25°C).

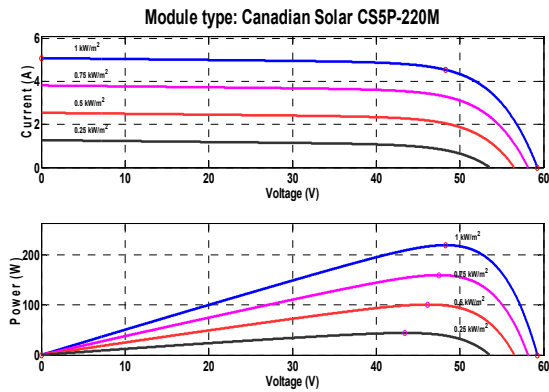

Fig. 4 I-V and P-V Characteristics of One Module at 25°C

2. I-V and P-V Characteristics of One Array at 25°C

The photovoltaic array consists of 66 strings of 5 series-connected Canadian Solar CS5P-220M modules, is simulated for different values of irradiance (kW/m^2). Fig. 5 shows I-V and P-V characteristics of the array for different values of irradiance at constant temperature (25°C).

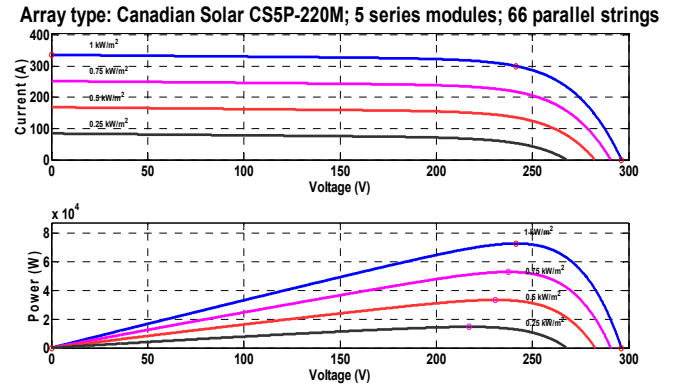

Fig. 5 I-V and P-V Characteristics of One Array at 25°C

B. Simulation of Grid Connected PV Module with IC as MPPT Algorithm

This simulation uses 100-kW PV array is connected to a 25-kV grid via a DC-DC boost converter and a three-phase three-level Voltage Source Converter (VSC). Maximum Power Point Tracking (MPPT) is implemented in the boost converter by means of a Simulink model using the 'Incremental Conductance + Integral Regulator' technique. PV array used in simulation delivers a maximum of 300 kW at 1000 W/m^2 irradiance as shown in Fig. 6.

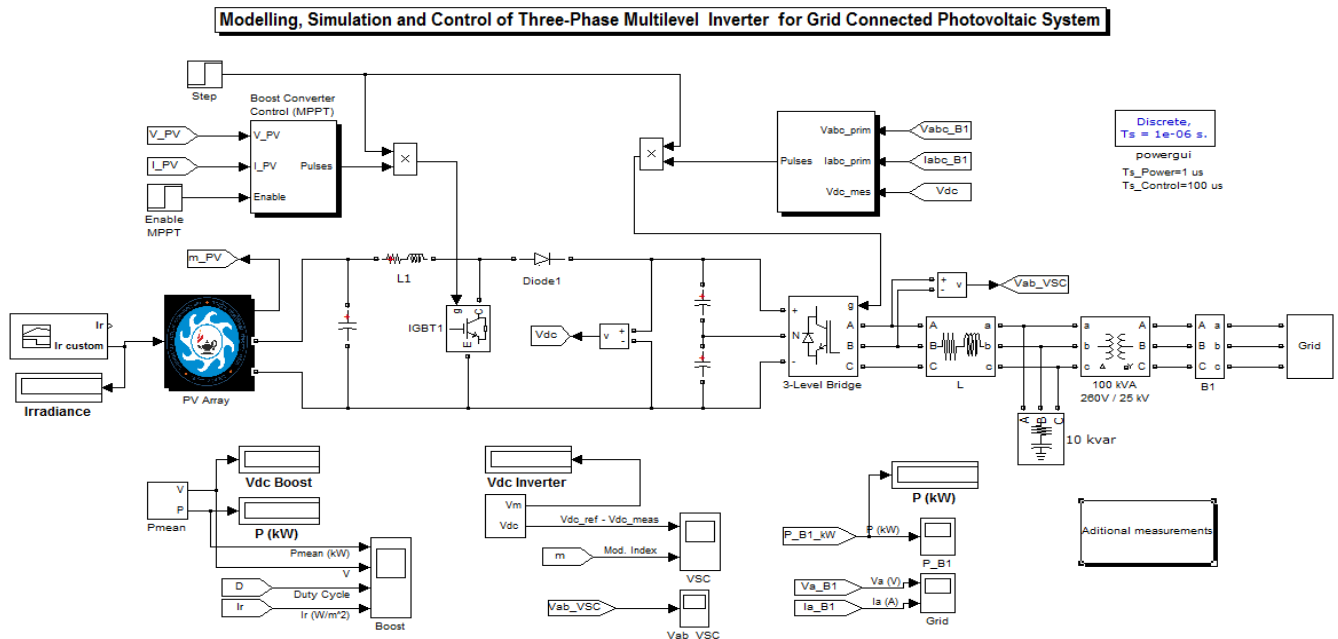

Fig. 6 Simulation of PV Module with IC as MPPT Algorithm

DC-DC boost converter has a frequency of 5-kHz with increasing voltage from PV natural voltage (273 V DC at maximum power) to 500 V DC. Switching duty cycle is optimized by a MPPT controller that uses the 'Incremental Conductance + Integral Regulator' technique. This MPPT system automatically varies the duty cycle in order to generate the required voltage to extract maximum power.

The VSC converts the 500V DC link voltage to 260V AC and keep unity power factor. The VSC control system uses two control loops:

- external control loop which regulates DC link voltage to +/- 250 V and
- Internal control loop which regulates I_d and I_q grid currents (active and reactive current components).

I_d current reference is the output of the DC voltage external controller. I_q current reference is set to zero in order to maintain unity power factor. V_d and V_q voltage outputs of the current controller are converted to three modulating signals U_{abc_ref} used by the PWM Generator. The control system uses a sample time of 100 microseconds for voltage and current controllers as well as for the PLL synchronization unit. Pulse generators of Boost and VSC converters use a fast sample time of 1 microsecond in order to get an appropriate resolution of PWM waveforms.

PV array used in simulation delivers a maximum of 300 kW at 1000 W/m² irradiance. VSC produces harmonics which is filtered by a 10-kvar capacitor bank. Three-phase coupling transformer has a rating of 100-kVA 260V/25KV. Utility grid has specification of (25-kV distribution feeder + 120 kV equivalent transmission system).

1. Simulation Results of PV Module with IC as MPPT Algorithm

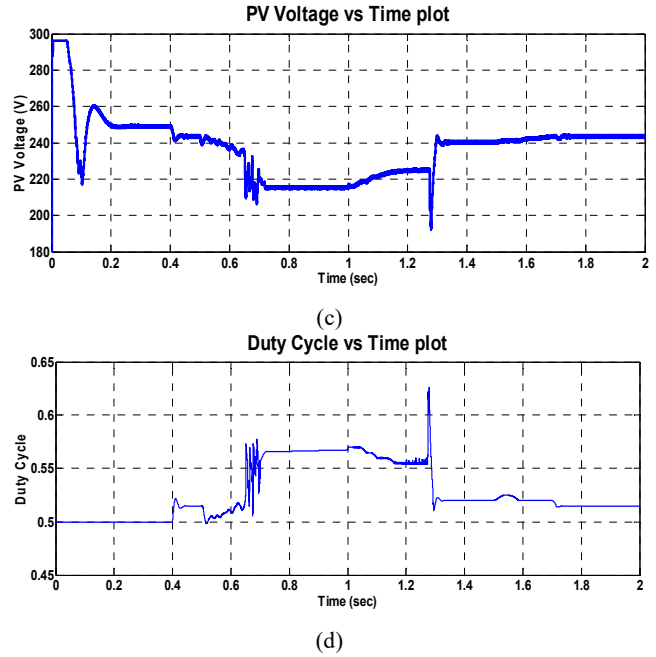
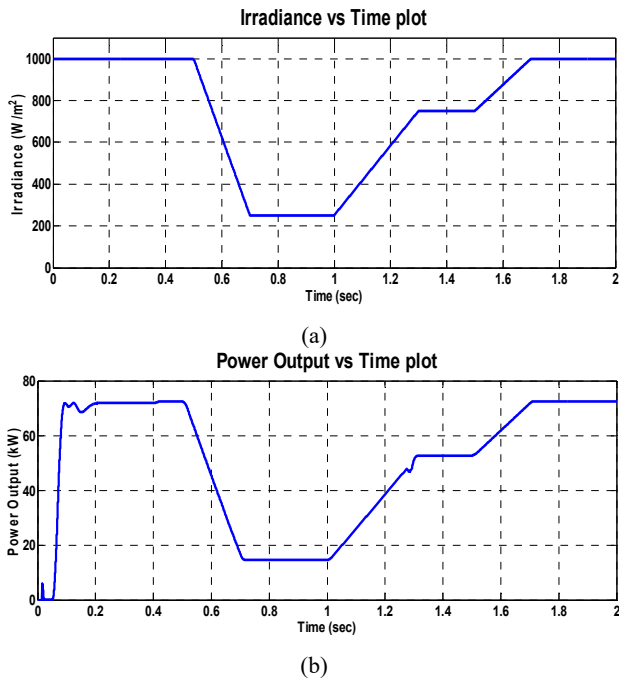

Fig. 7 Output at Boost Converter

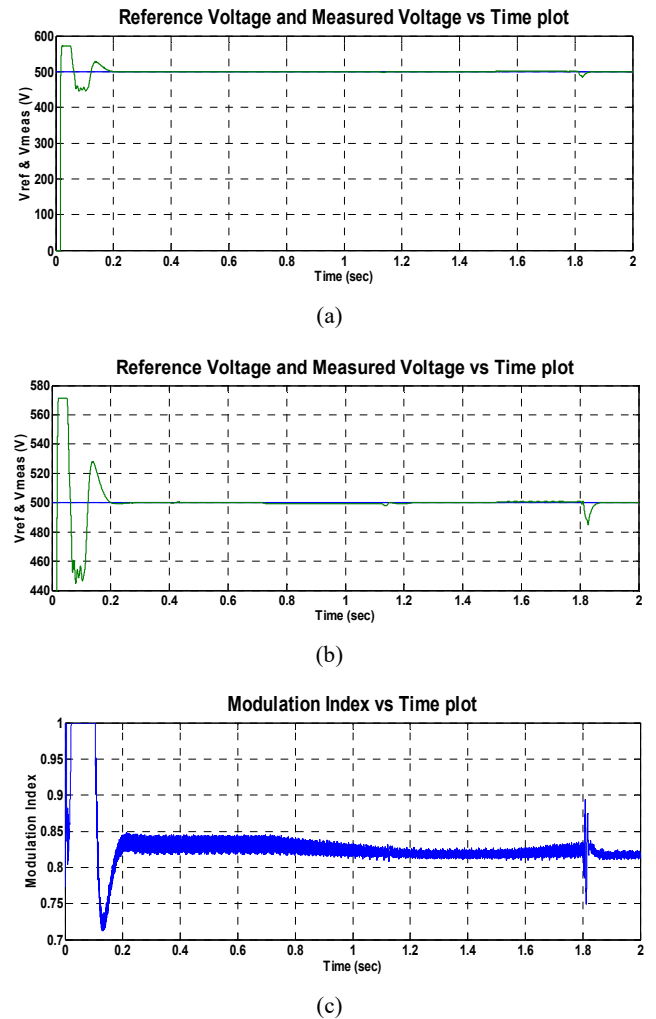

Fig. 8 Output of voltage source converter

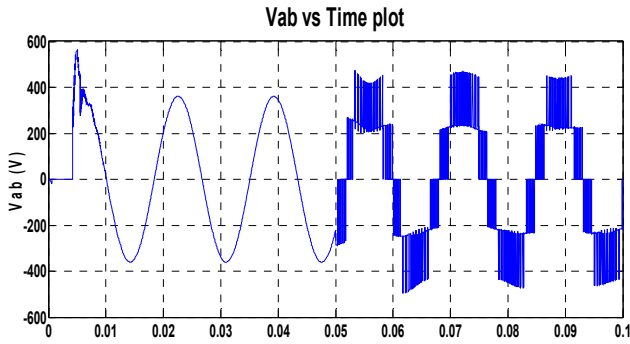

Fig. 9 Output at the inverter

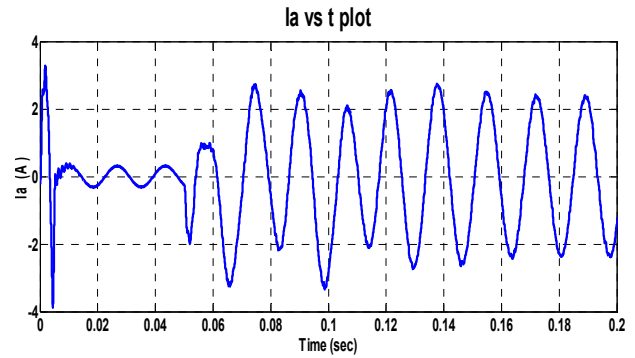
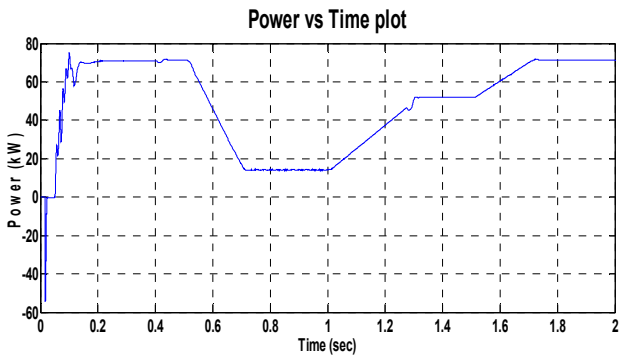
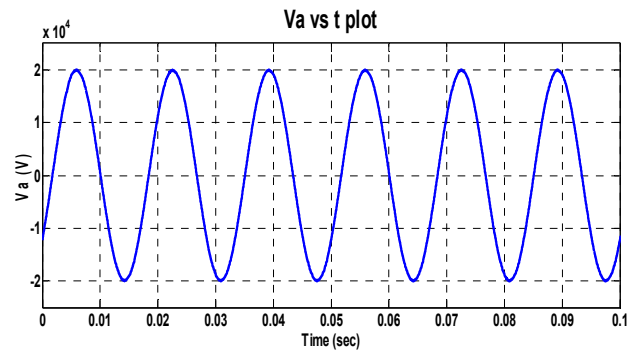

Fig. 10 Output at the grid



(a)



(b)

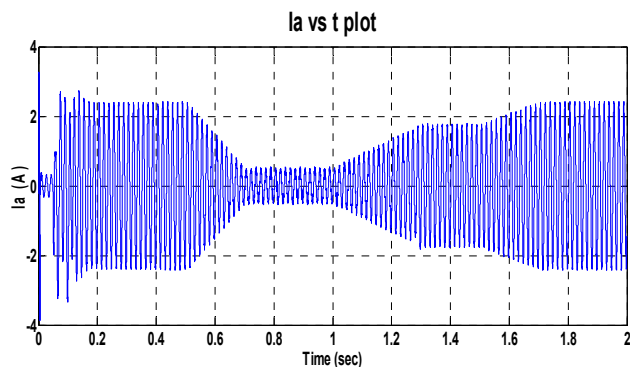

(c)

C. Simulation of Grid Connected PV Module with P&O as MPPT Algorithm

A 100-kW PV array is connected to a 25-kV grid via a DC-DC boost converter and a three-phase three-level Voltage Source Converter (VSC). Maximum Power Point Tracking (MPPT) is implemented in the boost converter by means of a Simulink model using the 'Perturb & Observe' technique. The average model contains the following components:

- PV array delivering a maximum of 100 kW at 1000 W/m² sun irradiance.
- DC-DC boost converter
- 3-level 3-phase VSC
- 100-kVA 260V/25kV three-phase coupling transformer
- Utility grid (25-kV distribution feeder + 120 kV equivalent transmission systems).

The main difference between the previous model and this model is in the way that DC-DC boost converter and three-phase VSC are modeled. In this model the boost and VSC converters are represented by equivalent voltage sources generating the AC voltage averaged over one cycle of the switching frequency. Such a model does not represent harmonics, but the dynamics resulting from control system and power system interaction is preserved. This model allows using much larger time steps than the detailed model (50 microseconds v/s 1 microsecond), resulting in a much faster simulation. In the IC model the PV-array model contains an algebraic loop. This algebraic loop is required to get an iterative and accurate solution of the PV model when large sample times are used. This algebraic loop is easily solved by Simulink. The 'Perturb and Observe' MPPT algorithm is implemented in the MPPT Control MATLAB Function block.

Modelling, Simulation and Control of Three-Phase Multilevel Inverter for Grid Connected Photovoltaic System

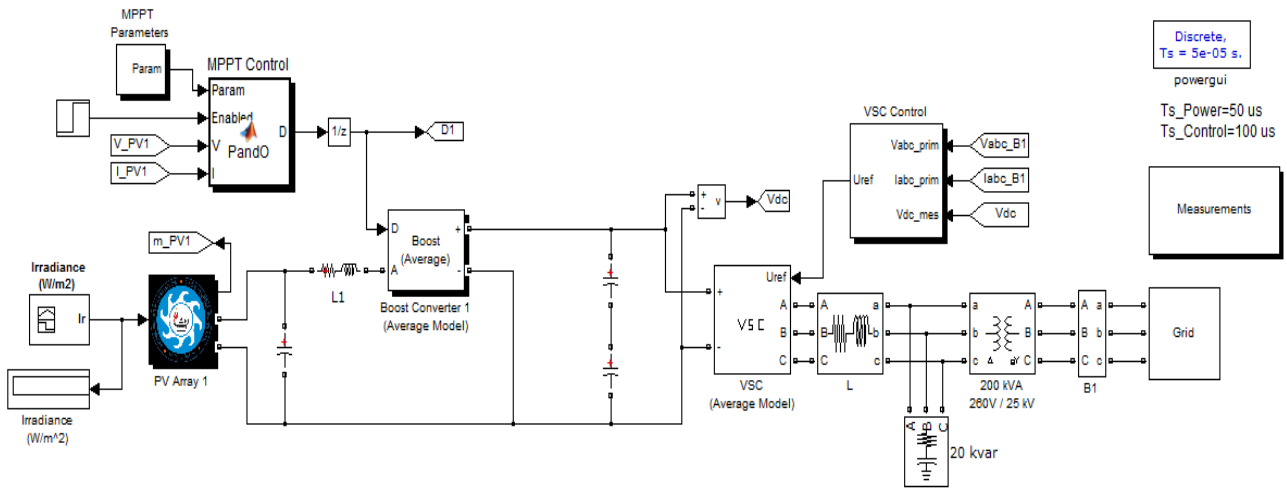

Fig. 11 Simulation of PV Module with P&O as MPPT Algorithm

1. Simulation Outputs of PV Module with P&O as MPPT Algorithm

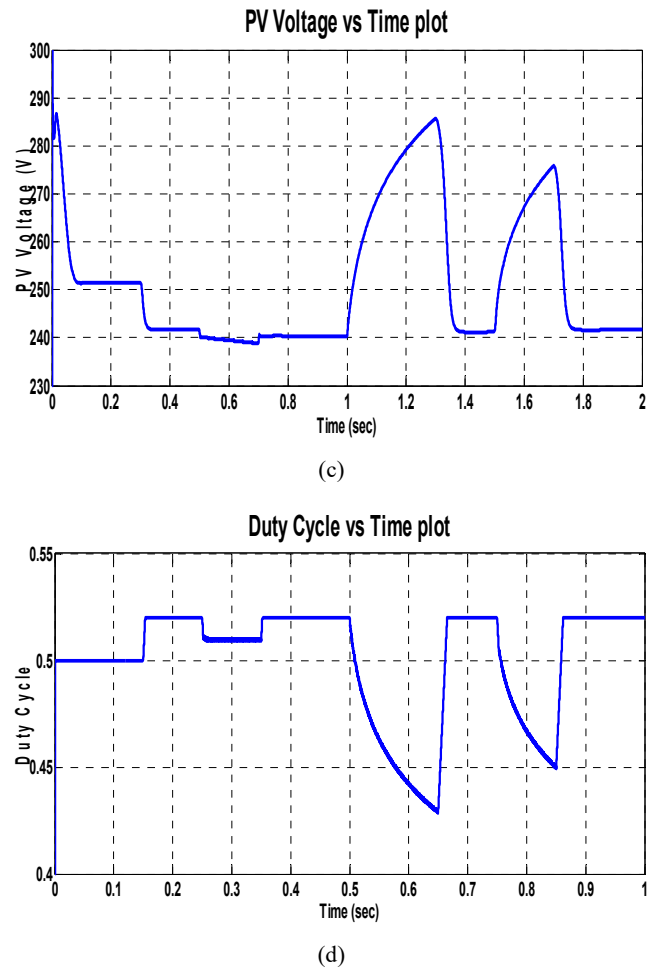
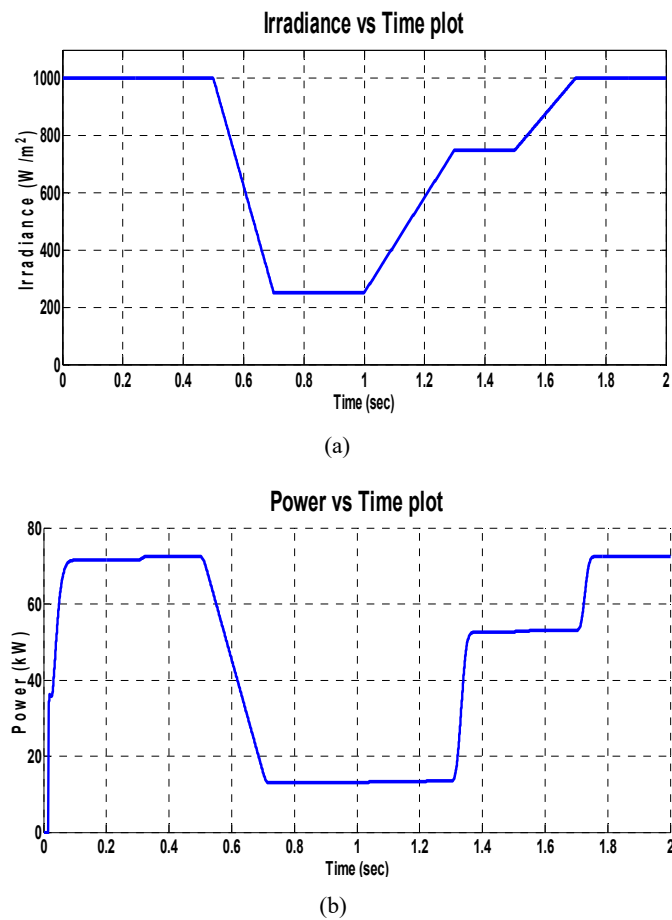
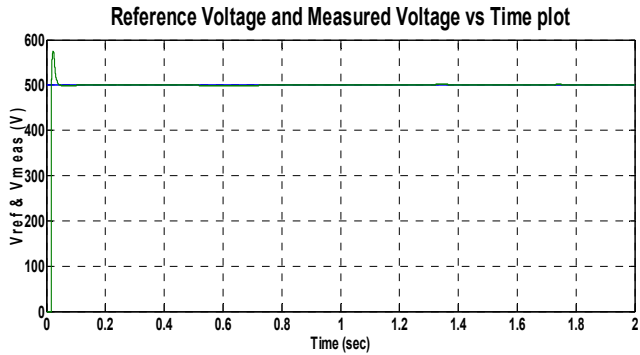
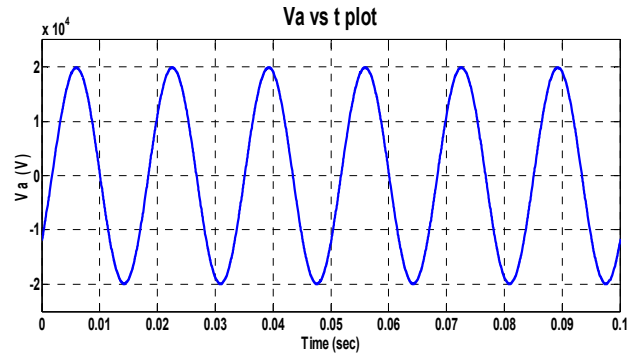

Fig. 12 Output at Boost Converter



(a)



(a)

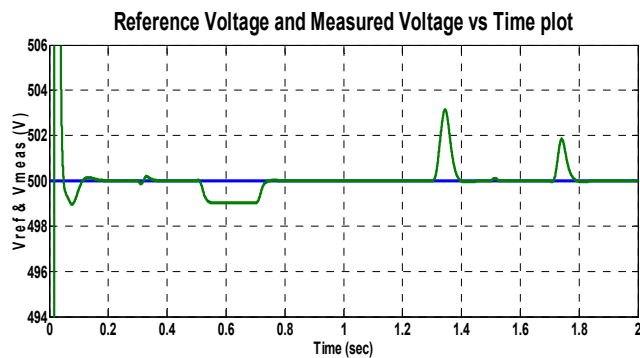

(b)

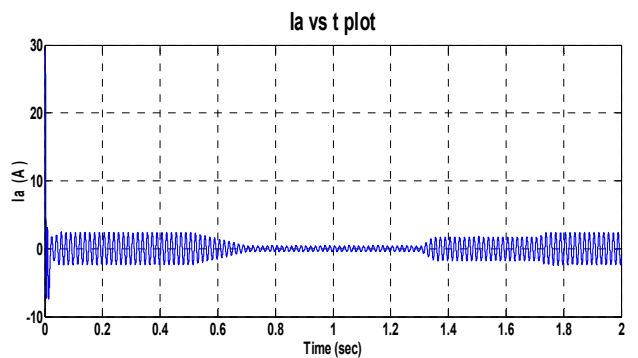

(b)

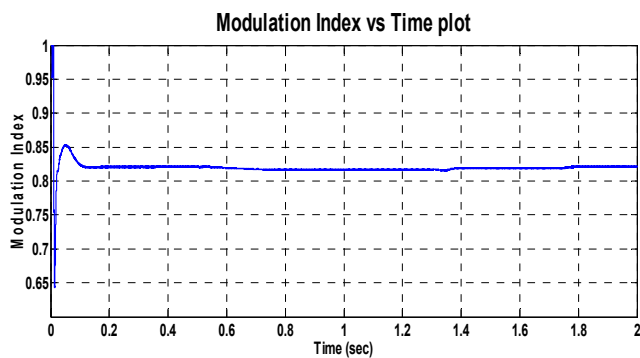

(c)

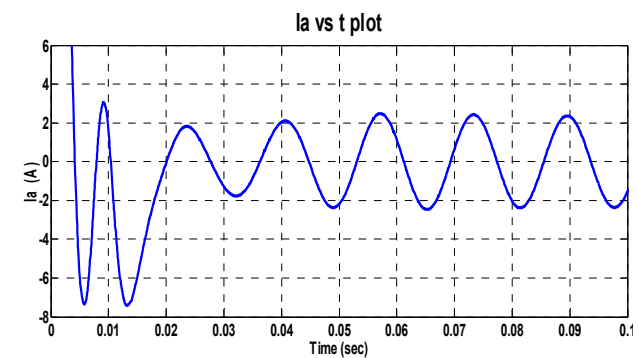

(c)

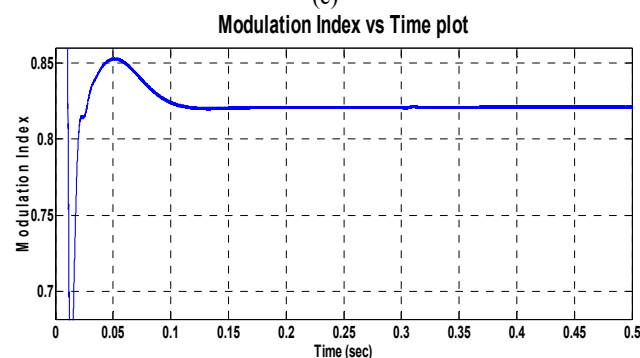

(d)

Fig. 13 Output of voltage source converter

Fig. 14 Output at the grid

V. CONCLUSION

A Photovoltaic system not only consist of PV modules but also involves good deal of power electronics as an interface between PV modules and load for effective and efficient utilization of naturally available Sun power. Such a PV model is easy to be used for the implementation on MATLAB/Simulink modeling and simulation platform.

Simulation of PV module &MPPT to maximize power has been performed. MPPT methods used in this paper are Perturb and Observe method and Incremental Conductance. Incremental conductance is found to be more stable than perturb & observe. Output voltage using IC method varies less in rapidly varying atmospheric conditions. More power is generated in IC than P&O algorithm with same varying

irradiance values. IC algorithm has less settling time than P&O.

P&O under steady-state conditions was insignificant for the optimized algorithms. Incremental conductance Outperformed P&O under partly cloudy conditions, as expected, but the difference was very small. Also, interestingly, P&O had a significantly higher efficiency than incremental conductance under cloudy skies.

The output voltage and current of PV module has been studied under different conditions of irradiance and temperature. The increase in the irradiance results in increase in overall power of the solar PV panel and the increase in the temperature results in decrease in voltage and a slight increase in current. Hence decrease in overall power and efficiency of PV panel. Output of the inverter is controlled by VSC controller to synchronous the output of inverter with the grid.

REFERENCES

- [1] SPV Market Research, San Jose, California, USA The history of photovoltaic industry pricing and future direction in a low incentive environment. *Photovoltaic Specialists Conference (PVSC)*, Volume 2, 2012 IEEE 38th.
- [2] L. Piegari, R. Rizzo, "Adaptive perturb and observe algorithm for photovoltaic maximum power point tracking," *Renewable Power Generation, IET*, vol. 4, no. 4, pp. 317-328, July 2010.
- [3] A. Adamczyk, R. Teodorescu, R. N. Mukerjee and P. Rodriguez, "Overview of FACTS devices for solar power plants directly connected to the transmission network," in *Proc. 2010 IEEE International Symposium on Industrial Electronics*, pp. 3742-3748.
- [4] Murtaza, A.F. ; Fac. of Eng., Univ. of Central Punjab, Lahore, Pakistan ; Sher, H.A.; Chiaberge, M.; Boero, D. Comparative analysis of maximum power point tracking techniques for PV applications. *Multi Topic Conference (INMIC), 2013 16th International*.
- [5] Jin-Gook Lee; Dept. of Electr. Control Eng., Sunchon Nat. Univ., Sunchon, South Korea ; Jae-Sub Ko ; Da-EunJeong ; Dong-Hwa Chung, MPPT control of photovoltaic system using the two-mode IC method, *Control, Automation and Systems (ICCAS), 2012 12th International Conference*.
- [6] K.H. Hussein, I. Muta, T. Hoshino, M. Osakada, "Maximum photovoltaic power tracking: an algorithm for rapidly changing atmospheric conditions," *IEE Proceedings on Generation, Transmission and Distribution*, vol. 142, no. 1, pp. 59-64, Jan 1995.
- [7] T. Esum, P. L. Chapman: "Comparison of Photovoltaic Array Maximum Power Point Tracking Techniques" *IEEE Transaction on Energy Conversion*, Vol. 22, No. 2, pp. 439-449, 2007.
- [8] H. Patel and V. Agarwal : "Maximum Power Point Tracking Scheme for PV Systems Operating Under Partially Shaded Conditions" *IEEE Transaction on Industrial Electronics*, Vol.55, No. 4, pp.1689-1698, 2008.
- [9] N. Femia, G. Petron, G. Spagnuolo, and M. Vitelli, "Optimization of perturb and observe maximum power point tracking method", *IEEE Trans. Power Electron.*, Vol. 20, No. 4, pp. 963-973, July 2005.



Arvind Kumar was born in Varanasi, Uttar Pradesh, India on 30th October 1992. He is an undergraduate student at Department of Electrical & Electronics Engineering, National Institute of Technology Goa, Ponda, Goa, India. He will receive his B. Tech degree in October 2014. His major fields of interest are power electronics, power systems.

He did a summer internship on Communication and Safety System in Ships at Goa Shipyard Limited, Goa, India. Mr. Kumar is a student member of IEEE.



Manoj Kumar was born in Pilani, Rajasthan, India on 1st June 1994. He is an undergraduate student at Department of Electrical & Electronics Engineering, National Institute of Technology Goa., Ponda, Goa, India. He will receive his B.Tech degree in October 2014. His major fields of interest are power electronics and Energy Auditing.

He did a summer internship on PLC & SCADA at NBC Bearings, Jaipur, Rajasthan, India. Mr. Manoj is a student

member of IEEE.



Dattatraya H. Nagaraj was born in Gadag, Karnataka, India on 4th January 1993. He is an undergraduate student at Department of Electrical & Electronics Engineering, National Institute of Technology Goa., Ponda, Goa, India. He will receive his B. Tech degree in October 2014. His major fields of interest are power electronics and Energy Auditing.

He did a summer internship at IFB Verna, Goa, India.

Mr. Nagaraj is a student member of IEEE.



Amanpreet Singh was born in Mumbai, Maharashtra, India on 1st June 1991. He is an undergraduate student at Department of Electrical & Electronics Engineering, National Institute of Technology Goa., Ponda, Goa, India. He will receive his B. Tech degree in October 2014. His major fields of interest are Power systems and Control System.

He did a summer internship on Single Line Diagrams of

Industry and CNC Machine at BHEL Punjab, India. Mr. Singh is a student member of IEEE.



Ms. Jayanthi Prattipati was born in Tenali, Andhra Pradesh, India on 12th Aug 1989. She completed her B.E and Masters (M. Tech) in the years 2010 and 2012 respectively. She has been working in N.I.T Goa to date. Her areas of interest include Renewable Energy Sources, Power Electronics Interface for Renewable energy sources and Power Electronics Applications to Power Systems.