

FWM Aware Fuzzy Dynamic Routing and Wavelength Assignment in Transparent Optical Networks

Debajyoti Mishra, Urmila Bhanja

Abstract—In this paper, a novel fuzzy approach is developed while solving the Dynamic Routing and Wavelength Assignment (DRWA) problem in optical networks with Wavelength Division Multiplexing (WDM). In this work, the effect of nonlinear and linear impairments such as Four Wave Mixing (FWM) and amplifier spontaneous emission (ASE) noise are incorporated respectively. The novel algorithm incorporates fuzzy logic controller (FLC) to reduce the effect of FWM noise and ASE noise on a requested lightpath referred in this work as FWM aware fuzzy dynamic routing and wavelength assignment algorithm. The FWM crosstalk products and the static FWM noise power per link are pre computed in order to reduce the set up time of a requested lightpath, and stored in an offline database. These are retrieved during the setting up of a lightpath and evaluated online taking the dynamic parameters like cost of the links into consideration.

Keywords—Amplifier spontaneous emission (ASE), Dynamic routing and wavelength assignment, Four wave mixing (FWM), Fuzzy rule based system (FRBS).

I. INTRODUCTION

CURRENTLY, transparent optical networks are considered to be the most reliable and economical solution to achieve high transmission capacities with quality of transmission (QoT) and also provide support to huge traffic in the future communication networks. To transfer data in wavelength routed optical network, a lightpath must be established between a source and a destination pair by a routing and wavelength assignment (RWA) technique.

In transparent optical communication network, lightpath is a channel between two nodes, which consists of one or more fiber links. The complexity arises for selection of a lightpath with appropriate wavelength between pair of nodes in the network. Wavelength continuity is a common constraint in wavelength routed networks, where every link in the lightpath must share a free common wavelength. A proper RWA scheme must be implemented in order to avoid blocking in future connection requests. As the optical signal from the source node propagates along a lightpath in a transparent optical network towards the destination node, the quality of signal degrades as there is no OEO (Optical-Electronic-Optical) conversion and therefore, the bit error rate (BER) of the signal increases at the destination node. BER above the threshold level is unacceptable by the user. During the routing

of signals, as the transmission distance increases the optical signal undergoes various physical impairments such as noise generated in optical amplifiers, nonlinear crosstalk appearing in WDM or dense wavelength division multiplexing (DWDM) systems due to the fiber nonlinear effects like cross phase modulation (CPM) and four wave mixing (FWM), inter symbol interference because of fiber chromatic dispersion (CD) and polarized mode dispersion (PMD), etc. These impairments affect the optical networks and their effects increase with an increase in the propagation distance. The quality of signals in an optical network, which is measured by the BER, is therefore dependent on the network state. Unlike linear impairments, non-linear impairments not only affect each optical channel individually, but also cause disturbance and interference among them. One such major impairment is FWM, in which signals at different wavelengths interact resulting in generation of new signals called the FWM components. Some of these FWM components interfere with the original signals and degrade their quality [1]. The number of FWM components generated increases with the increase in the number of users. FWM severely degrades the network performance if the input power is large and/or the channel spacing is narrow [1]. Although, nonlinear impairments like self-phase modulation (SPM) and cross phase modulation (XPM), which come into play only at high data rates are considered by some of the authors; the effect of four wave mixing (FWM), which may degrade the signal quality in a WDM or a DWDM system even at moderate powers and bit rates, has received very little attention while addressing the dynamic routing and wavelength assignment (DRWA) problem. However, very few papers consider nonlinear effect like FWM on a DRWA problem [1]-[6]. There are very few research works available that use metaheuristics to solve the impairment aware DRWA problem [1], [3]-[6]. Marsden et al, have proposed a DRWA algorithm assuming that the quality of service (QoS) of lightpaths is degraded mainly due to the FWM generated noise [2]. The same authors have also reported a mechanism to reduce the set up time for a lightpath in this FWM aware DRWA algorithm by pre-computing the FWM crosstalk power. However in this work, the authors have assumed the link lengths to be the same [4]. Tan et al, have developed a FWM aware wavelength assignment using Ant colony optimization (ACO), where they have tried to establish correlation between input signal power and FWM crosstalk power [3].

Debajyoti Mishra and Dr. Urmila Bhanja, are Assistant Professors with the Indira Gandhi Institute of Technology, Sarang, India, 759145 (e-mail: debaigit@gmail.com, urmilabhanja@gmail.com).

Very few research works have been carried out, considering fuzzy approach for the lightpath establishment in QoS aware-DRWA technique. In one of the recent paper, the authors have tried to improve the blocking probability and minimizing the average number of hops in the work, where the inputs to fuzzy systems are traffic load and number of hops [7]. In another research paper, the authors have designed a Fuzzy Rule Based System (FRBS) to establish a RWA scheme using Generalized Multiprotocol Label Switching (GMPLS) over WDM network, where the inputs to fuzzy systems are request bandwidth, average utilization of each wavelength and coefficient of data traffic and output determines the probability of a successful connection request [8]. In these approaches, the algorithms implement fuzzy logic on the network Quality of service aware (QoS) parameters, but ignore the physical layer impairments such as quality of transmission aware (QoT) parameters.

The main objective of the proposed work in this work is to compare the performances such as mean blocking probability and mean execution time between the FWM aware metaheuristic approaches using evolutionary programming (EP) algorithm and simulated annealing (SA) with the proposed FWM-aware-FDRWA algorithm [6]. Previous work considers the ASE noise and the crosstalk components due to the FWM effect while minimizing the connection blocking probability using both EP and SA approaches [6]. In this paper, the proposed FWM-aware-FDRWA, also considers the impairments such as FWM and ASE for the establishment of lightpath. In order to reduce the set up time of a lightpath, the FWM crosstalk products and the static partial powers of all the FWM terms are calculated offline and are stored in a database. During the online evaluation of signal quality, the FWM crosstalk power for the corresponding links are retrieved from the database and then the quality of signal is evaluated dynamically taking the link length into consideration. In this paper, the quality of signal measured in terms of BER, is also evaluated, in addition to, finding a wavelength continuous path. If the BER is found to be below a threshold level then the call request is accepted otherwise, rejected.

The rest of the paper is organized as follows: Section II gives a brief description about FWM crosstalk in a multichannel system Section III introduces the problem definition and system model. Section IV describes the proposed algorithm (QoT-aware FDRWA). Section V describes the simulation results. Finally, Section VI concludes the paper.

II. FWM CROSSTALK IN A MULTICHANNEL SYSTEM

One of the major nonlinear impairments encountered in signal propagation in optical fiber is FWM in which three signals of different wavelengths interact to generate a fourth wavelength that can interfere with the information signal and results in performance degradation [1], [6]. When the number of channels in a WDM transmission system with W equally spaced channels is greater than three, FWM manifests itself in terms of a large number of interfering signals. If W is the total number of wavelengths available, the number of interfering

signals equals $W^2(W-1)/2$, corresponding to the frequencies $f_{rlm} = f_r + f_l - f_m$ with r, l , and m varying from 1 to W . In the case of equally spaced channels, most of the interfering signal frequencies coincide with the existing channel frequencies, thereby affecting the signals in these channels [1], [6].

III. PROBLEM DEFINITION AND SYSTEM MODEL

A. Problem Definition

For the impairment based DRWA problem the lightpath requests are assumed to arrive at the network dynamically following a Poisson process with an average arrival rate of Λ . A lightpath request is specified by three attributes: S, D, and T_h , which respectively represent the source node, the destination node, and the holding time, for the request. The source and the destination for each request are uniformly randomly distributed. The holding time for a lightpath request are assumed to be exponentially distributed with fixed mean, $T_{hold} = E[T_h]$. During this holding time duration, the network resources are reserved for the connection request. Once the holding time expires, the network resources are released to be used later by other incoming lightpath requests. The network load is defined as: Network load = $\Lambda \times T_{hold}$, the mean blocking probability, and the mean execution time, are defined as (Number of requests blocked / Total number of requests processed), (Total simulation time / Total number of requests) respectively.

B. The Network Model

It is assumed that the reduced version of NSFNET used to illustrate the proposed algorithm can be modeled as a graph $G(V, E)$, where V is the set of nodes, representing N wavelength routing nodes (WRNs), and E is the set of fiber links, representing physical connectivity between the nodes. Fig. 1 shows the network model assumed in this work [1], [6], [9].

The components present in a wavelength routing node (WRN) include a cross connect switch (XCS), optical power taps for monitoring signals, and a pair of EDFAs on either side of the XCS for signal amplifications. In the proposed model, the WRN also contains a transmitter array and a receiver array that helps in adding or dropping a local signal at any of the wavelengths at the node. The WRN's are connected through non-zero dispersion shifted optical fibers (NZDSF). It is assumed that there are no in-line amplifiers in the network. In this work, the effects of signal leaks in the optical cross connect switches and the effects of non-ideal filtering at the demultiplexer are neglected [1], [6].

C. Online Signal Power and Noise Power Evaluation Module

The calculation of received signal power, FWM crosstalk power, and ASE noise power along a lightpath during a call admission step is dynamic in nature. The signal power and the ASE noise power depend on the number of links traversed by the lightpath during the call admission phase and the associated link cost. The FWM crosstalk power depends on the number of different signals present in a link and the length

of the associated links that a lightpath traverses during the call admission phase. The signal power, the ASE noise power at the output of the k th intermediate node, and the FWM crosstalk power for the multichannel system are expressed for the path 'P' as below.

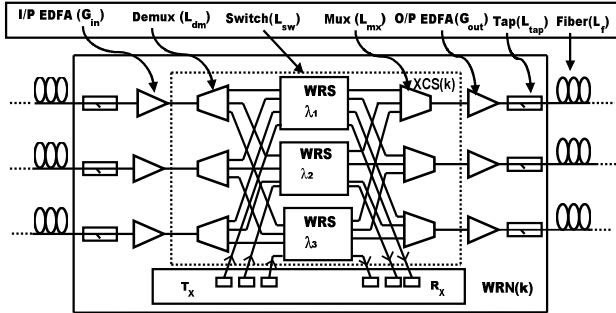

Fig. 1 Architecture of a wavelength routing node (WRN) [1], [6], [9]

In a multichannel system, each lightpath traverses H hops or links until it reaches its destination node. The accumulated FWM crosstalk power at the destination node for a path 'P', $P_{DNP}(f_r + f_l - f_m)$, is the sum of all the crosstalk components generated in the links traversed by the lightpath and is expressed as [1]:

$$P_{DNP}(f_r + f_l - f_m) = \sum_{c=1}^H \sum_{f_r} \sum_{f_l} \sum_{f_m} P_{rlm}(f_r, f_l, f_m) \quad (1a)$$

The FWM crosstalk power per link at the k th node for the path 'P' due to the three co-propagating signals at wavelengths $\lambda_r, \lambda_l, \lambda_m$ is expressed as [1], [6]:

$$P_{rlm}(k, \lambda_r, \lambda_l, \lambda_m) = (\eta D_{rlm})^2 \gamma^2 P_r P_l P_m e^{-\alpha L(k-1, k)} L_{eff}^2 G_{in}(k) \quad (1b)$$

$$L_{tap}^2 L_{mx}(k) L_{dm}(k) L_{sw}(k) G_{out}(k) / 9.0$$

The effective length L_{eff} for the k th node is expressed as

$$L_{eff} = \frac{(1 - e^{-\alpha L(k-1, k)})}{\alpha} \quad (1c)$$

$$P_{sigp}(k, \lambda_i) = p_{sigp}(k-1, \lambda_i) L(k-1, k) G_{in}(k) L_{dm}(k) \quad (2)$$

$$L_{sw}(k) L_{mx}(k) G_{out}(k) L_{tap}^2$$

$$p_{asep}(k, \lambda_i) = p_{asep}(k-1, \lambda_i) L(k-1, k) G_{in}(k) L_{dm}(k) L_{sw}(k) L_{mx}(k) \quad (3)$$

$$G_{out}(k) L_{tap}^2 + 2\eta_{sp} [G_{in}(k) - 1] \eta_{sp} B_o L_{dm}(k)$$

$$L_{sw}(k) L_{mx}(k) G_{out}(k) L_{tap}$$

$$+ 2\eta_{sp} [G_{out}(k) - 1] \eta_{sp} B_o L_{tap}$$

In (2) and (3), $L(k-1, k)$ denotes the length of the link between the $(k-1)$ th node and the k th node. $p_{sigp}(k, \lambda_i)$ represents the signal power of k th node at wavelength λ_i , $p_{sigp}(k-1, \lambda_i)$ represents the signal power of $(k-1)$ th node at

wavelength λ_i , $L(k-1, k)$ represents the fiber loss between the $(k-1)$ th and the k th node, and $G_{in}(k)$ and $G_{out}(k)$ respectively represent the gain of the EDFAs at the input and output of the k th node for any wavelength, $L_{dm}(k)$ represents the demultiplexer loss at the k th node, $L_{sw}(k)$ represents the switch loss at the k th node, $L_{mx}(k)$ represents the multiplexer loss at the k th node, L_{tap} represents the tap loss, $P_{asep}(k, \lambda_i)$ represents the ASE noise power of k th node at wavelength λ_i , $P_{asep}(k-1, \lambda_i)$ represents the ASE noise power of $(k-1)$ th node at wavelength λ_i , h is Planck's constant, ν_i is the optical frequency at λ_i , η_{sp} represents the spontaneous emission factor for the EDFAs, B_o represents the optical bandwidth, and D_{rlm} represents the degeneracy factor in the presence of the frequencies f_r, f_l , and f_m .

D. Online Bit Error Rate Evaluation Model

Optical signal received at the destination node in the presence of ASE noise and FWM crosstalk power can be expressed in (4) as [1]:

$$E_{R(p)}(t) = A \cos(2\pi\nu_i t + \phi(t)) + E_{ase(p)}(t) + E_{fwm(p)}(t) \quad (4)$$

The first term in (4) represents the signal component at frequency ν_i for the path 'P', A is the signal amplitude, and $\phi(t)$ is its phase. The second and the third terms respectively represent the received ASE noise power and the FWM crosstalk power at the receiver node for the path 'P'. The photodetector is a square law device and hence the received lightwave after photodetection produces a photocurrent is expressed in (5) as [1]:

$$i_{d(p)}(t) = i_{i(p)}(t) + i_{sig-ase(p)}(t) + i_{sig-fwm(p)}(t) + i_{ase-ase(p)}(t) + i_{fwm-fwm(p)}(t) \quad (5)$$

$$+ i_{fwm-ase(p)}(t) + i_{th}(t) + i_{shot(p)}(t)$$

Equation (5) represents the signal current received for bit '1' after photo detection, along with the beat noise components. Equations (6) and (7) represent the corresponding noise variances [1].

The first term in (5) represents the signal component and the rest of the terms represent the beat noise components for the path 'P'. The last two terms represent the thermal noise current and the shot noise current respectively. The combined noise can be modeled as a zero mean Gaussian random process with a variance given by,

$$\sigma_{i(p)}^2 = \sigma_{sig-ase(p)}^2 + \sigma_{ase-ase(p)}^2 + \sigma_{sig-fwm(p)}^2 + \sigma_{fwm-ase(p)}^2 \quad (6)$$

$$+ \sigma_{thermal}^2 + \sigma_{shot(p)}^2$$

In (6), $\sigma_{sig-ase(p)}^2$ represents signal-ASE beat noise components, $\sigma_{ase-ase(p)}^2$ denotes ASE-ASE beat noise, $\sigma_{sig-fwm(p)}^2$ denotes signal-FWM beat noise, $\sigma_{fwm-ase(p)}^2$ represents FWM-ASE beat noise in the presence of signal, $\sigma_{thermal}^2$ represents thermal noise variance, $\sigma_{shot(p)}^2$ represents shot noise variance [1], [6]. Equation (7) represents the variance

due to the beat noise components at the receiver when bit '0' is received by the photodetector [1].

$$\sigma_0^2(p) = \sigma_{ase-ase}^2(p) + \sigma_{ase-fwm0}^2(p) + \sigma_{thermal}^2 + \sigma_{shot}^2(p) \quad (7)$$

In (7), $\sigma_{ase-fwm0}^2(p)$ represents ASE-FWM beat noise variance for bit '0' for a path 'P'. The receiver BER due to the path 'P' is expressed in (8) as [1]:

$$\xi_x = 0.25 \left[\operatorname{erfc} \left(\frac{i_{1(p)}(t) - i_{th(p)}}{\sqrt{2}\sigma_1(p)} \right) + \operatorname{erfc} \left(\frac{i_{th(p)}}{\sqrt{2}\sigma_0(p)} \right) \right] \quad (8)$$

The receiver BER is evaluated with a fixed decision threshold $i_{th(p)}$. By suitably selecting the threshold, one can minimize the BER. In this work, the threshold value is fixed at $i_{1(p)}(t)/2$ [1]. The system parameters assumed in this work are identical to that used in [1].

IV. PROPOSED ALGORITHM

Fig. 9 depicts the block diagram of the proposed FWM-aware-FDRWA. The following steps sequentially describe the algorithm.

Step1. A call request arrival is assumed to follow a Poisson distribution. Source-destination pair follows a uniform random distribution and holding time follows (exponential/pareto) distribution [1], [10]. Paths are generated using dijkstra's shortest path algorithm [11]. A path in this work is defined as the collection of physically connected links from a source to a destination.

Step2. Each of these paths is checked with the availability of free channels per path (FCP). Different wavelength assignment techniques such as First Fit, Round Robin and Random wavelength assignment techniques are utilized to check the wavelength continuous paths [12], [13]. The calls corresponding to the paths that do not satisfy the wavelength constraints are blocked. The wavelength continuous paths are further evaluated to estimate the threshold value of BER constraint respectively. The calls corresponding to the lightpaths that do not satisfy the BER constraint at the destination node respectively are blocked. The paths that satisfy the wavelength constraint at the network layer and the BER constraint at the physical layer are fuzzified by a fuzzy logic controller (FLC).

Step3. The QoS and QoT parameters such as free channel per path (FCP), Path length (PL) and BER of the paths that satisfy both the physical layer and network layer constraints are passed serially through a FLC or a FRBS for fuzzification. The inputs to the fuzzy rule based inference system (FRBS) are fuzzified by Gaussian membership function with three fuzzy sets identified by linguistic variables such as low, high and very high. Similarly, the output space is divided into four fuzzy sets with Gaussian membership function and the linguistic variables attached are excellent, very

good, good, and poor. Figs. 2, 3, and 4 respectively show the membership functions of input variables such as log (BER), path length (PL) and free channel per path (FCP), and Fig. 5 represents the membership function of the output variable such as cost of the lightpath referred as cost per path (CP) in this work.

Step4. Table I shows the details of input values such as log (BER), free channel per path (FCP) and path length (PL) with specified ranges. In this work, BER range is chosen between 10^{-20} to 10^{-12} . Number of wavelengths considered in this work is sixteen and therefore, the range for FCP in this work ranges from one to sixteen.

Step5. All the twenty seven rules are developed for the FRBS as described in Table II. In the proposed fuzzy system, Mamdani minimum interference engine, Gaussian fuzzifier and center average defuzzifier are used [14].

TABLE I
 INFORMATION OF THE VARIABLES USED IN THE PROPOSED FRBS

Serial Number	Name	Type	Range (per path)	Members ip function
1	Log(BER)	Input	-20 to -12	Gaussian
2	Free Channels per Path (FCP)	Input	1-16	Gaussian
3	Path-length (PL)	Input	60-800 Km	Gaussian
4	Cost Per Path (CP)	Output	0-10	Gaussian

TABLE II
 RULES DEVELOPED FOR FRBS USED IN THE PROPOSED ALGORITHM

RULES	LogBER	FCP	PL	CP
1	L	VH	L	E
2	L	VH	H	E
3	L	VH	VH	E
4	L	H	L	E
5	L	H	H	VG
6	L	H	VH	VG
7	L	L	L	VG
8	L	L	H	VG
9	L	L	VH	G
10	H	VH	L	E
11	H	VH	H	VG
12	H	VH	VH	VG
13	H	H	L	VG
14	H	H	H	VG
15	H	H	VH	G
16	H	L	L	VG
17	H	L	H	G
18	H	L	VH	P
19	VH	VH	L	E
20	VH	VH	H	VG
21	VH	VH	VH	VG
22	VH	H	L	VG
23	VH	H	H	VG
24	VH	H	VH	G
25	VH	L	L	VG
26	VH	L	H	P
27	VH	L	VH	P

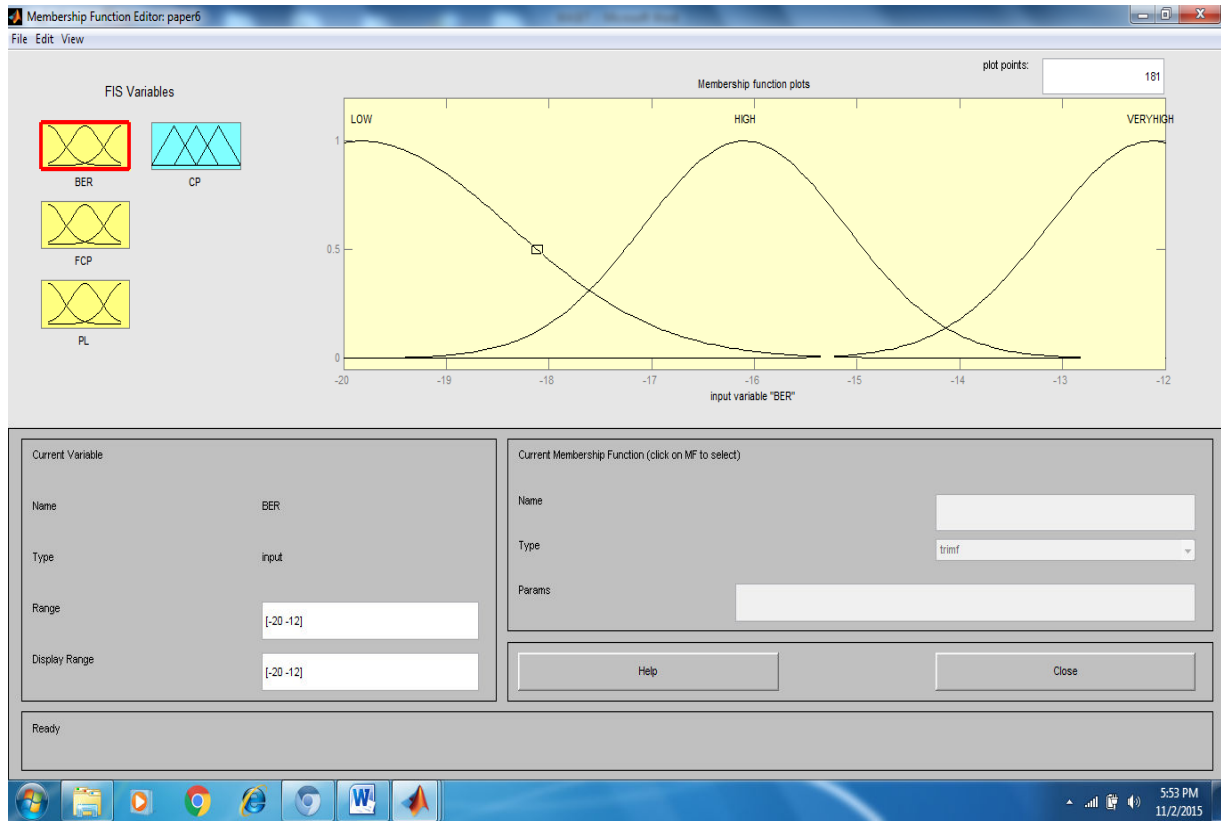

Fig. 2 Membership function of input variable Log BER

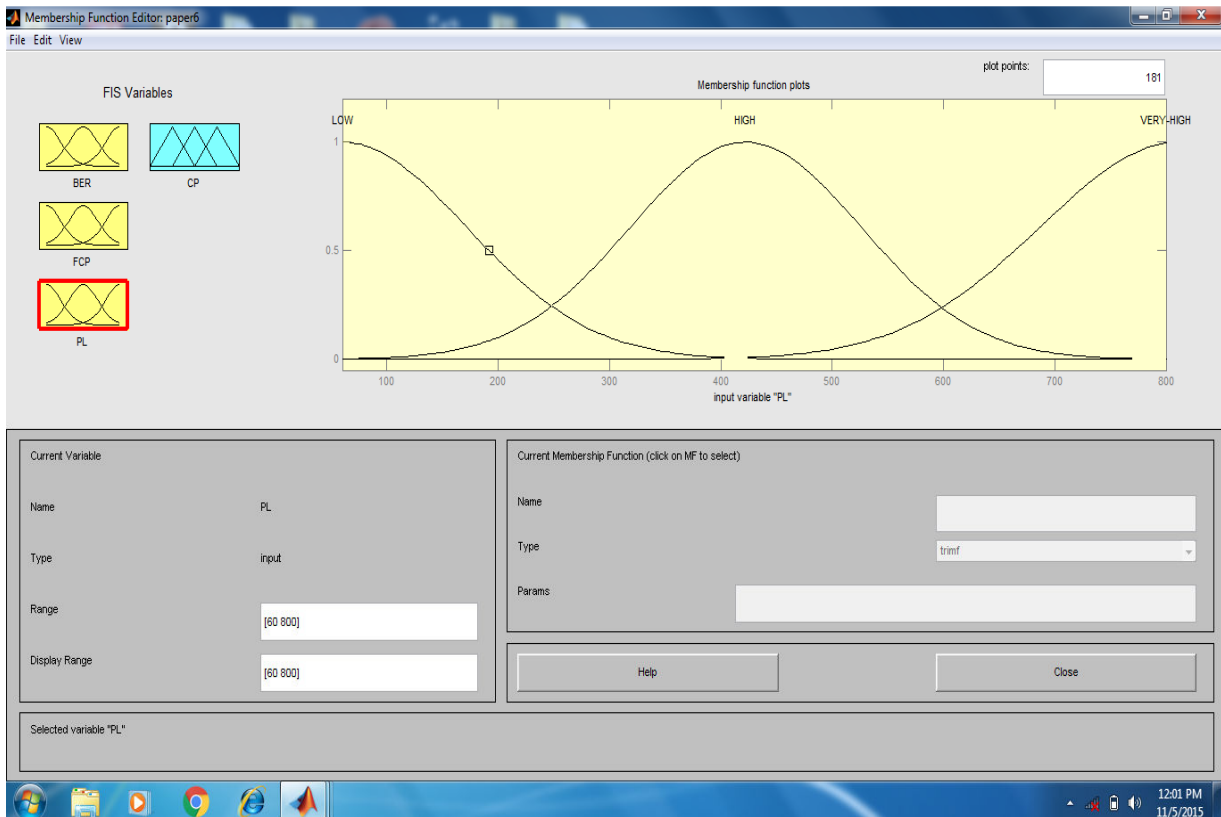

Fig. 3 Membership function of input variable PL

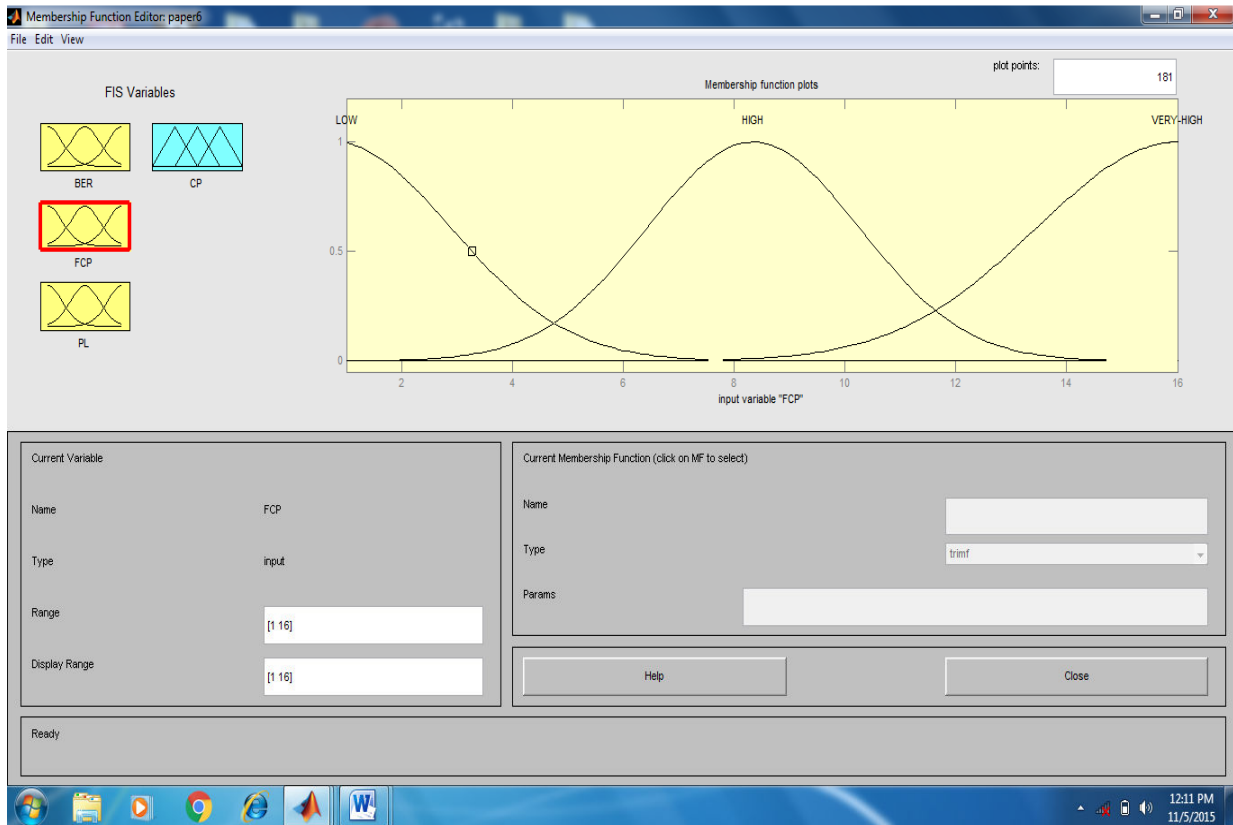

Fig. 4 Membership function of input variable FCP

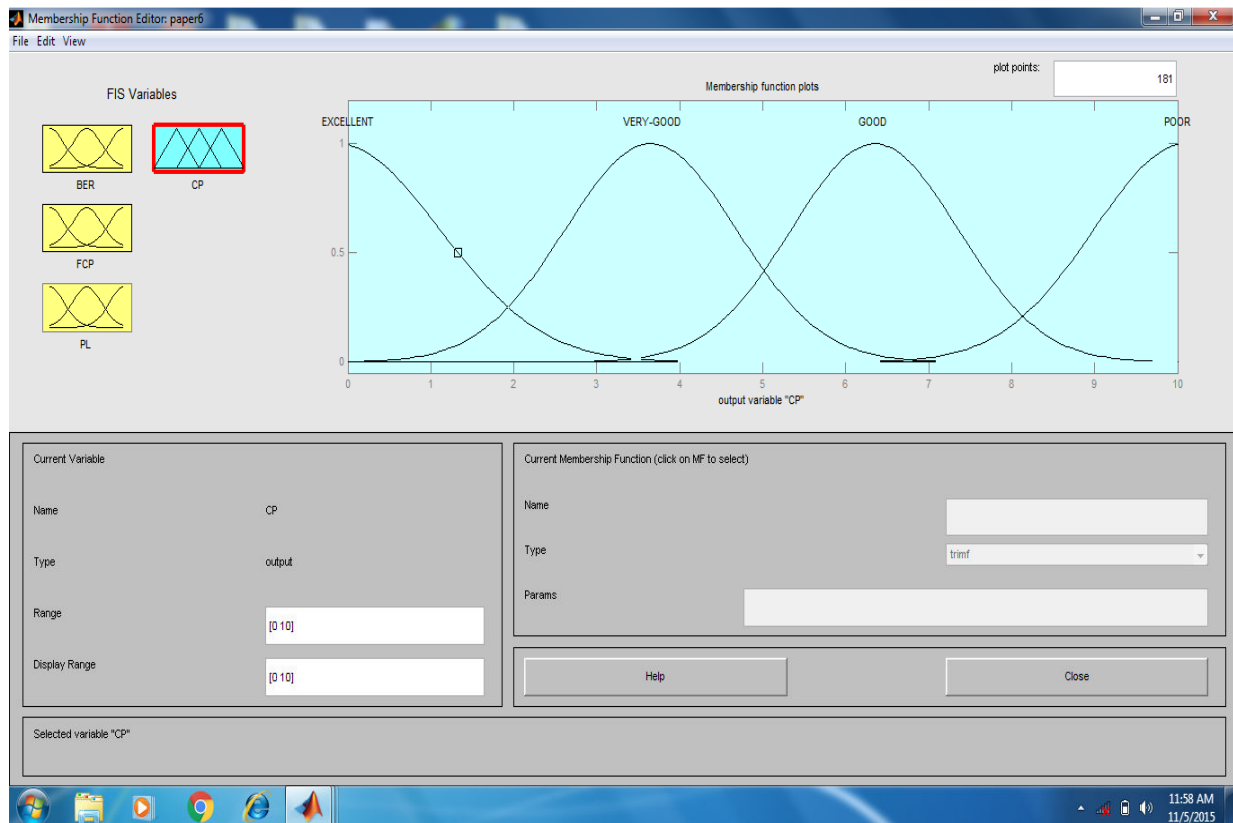

Fig. 5 Membership function of output variable CP

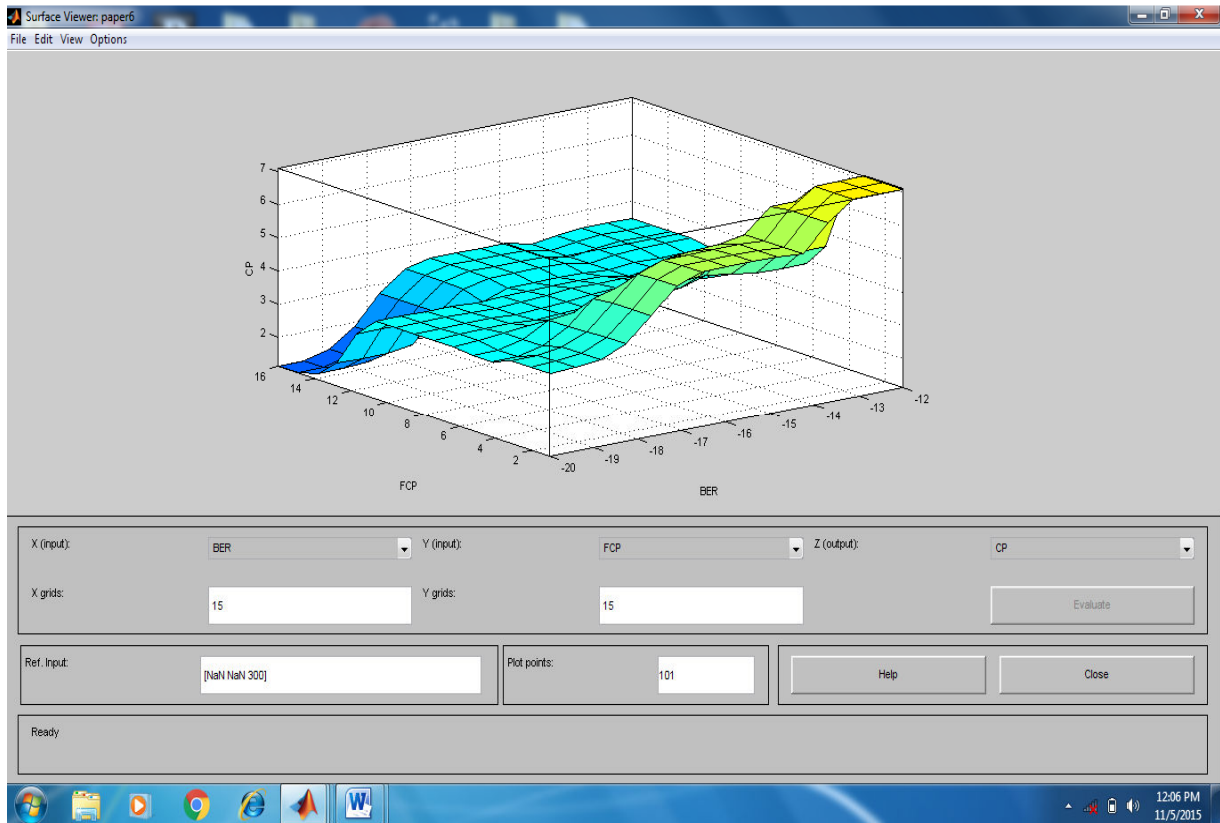

Fig. 6 3D- plot of input variables (BER & FCP) vs. output variable (CP) fixing third input variable PL at three hundred (300)

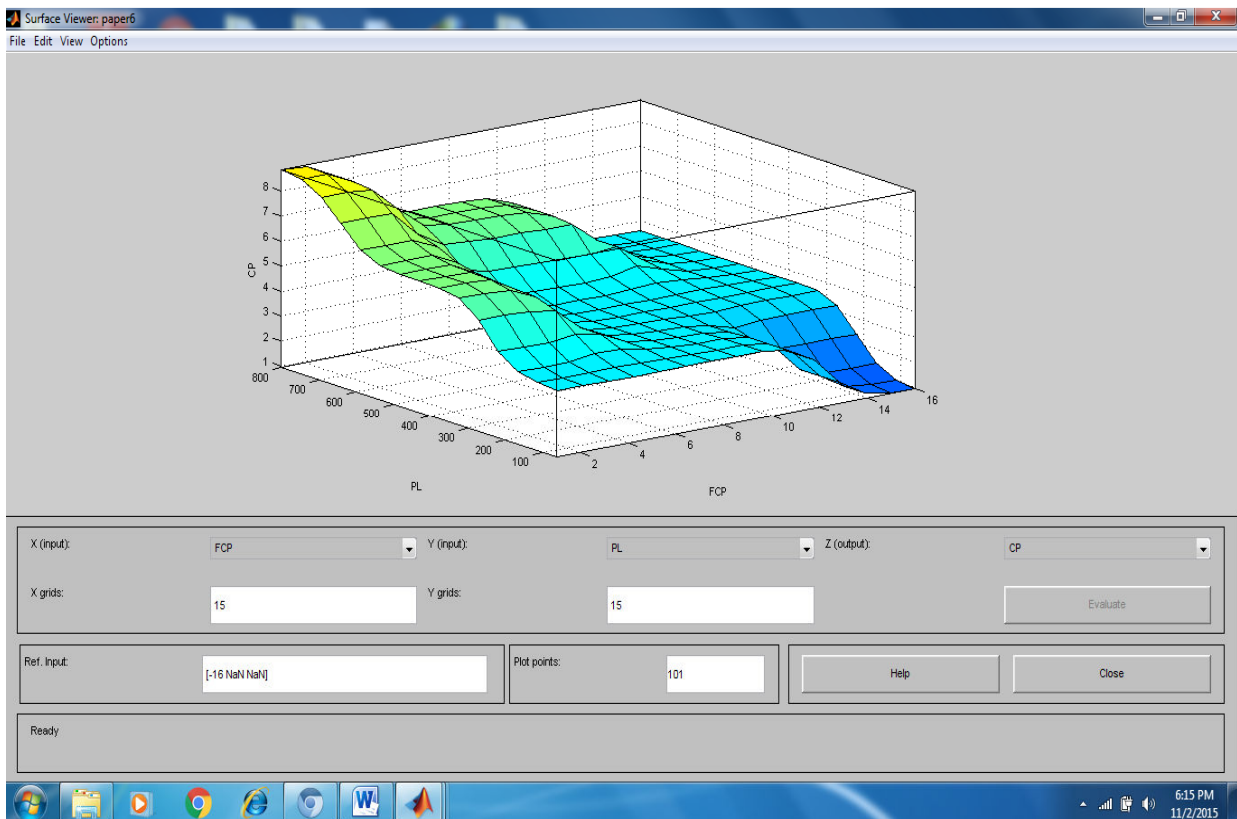

Fig. 7 3D- plot of input variables (FCP & PL) vs. output variable(CP) fixing third input variable BER at minus (-16)

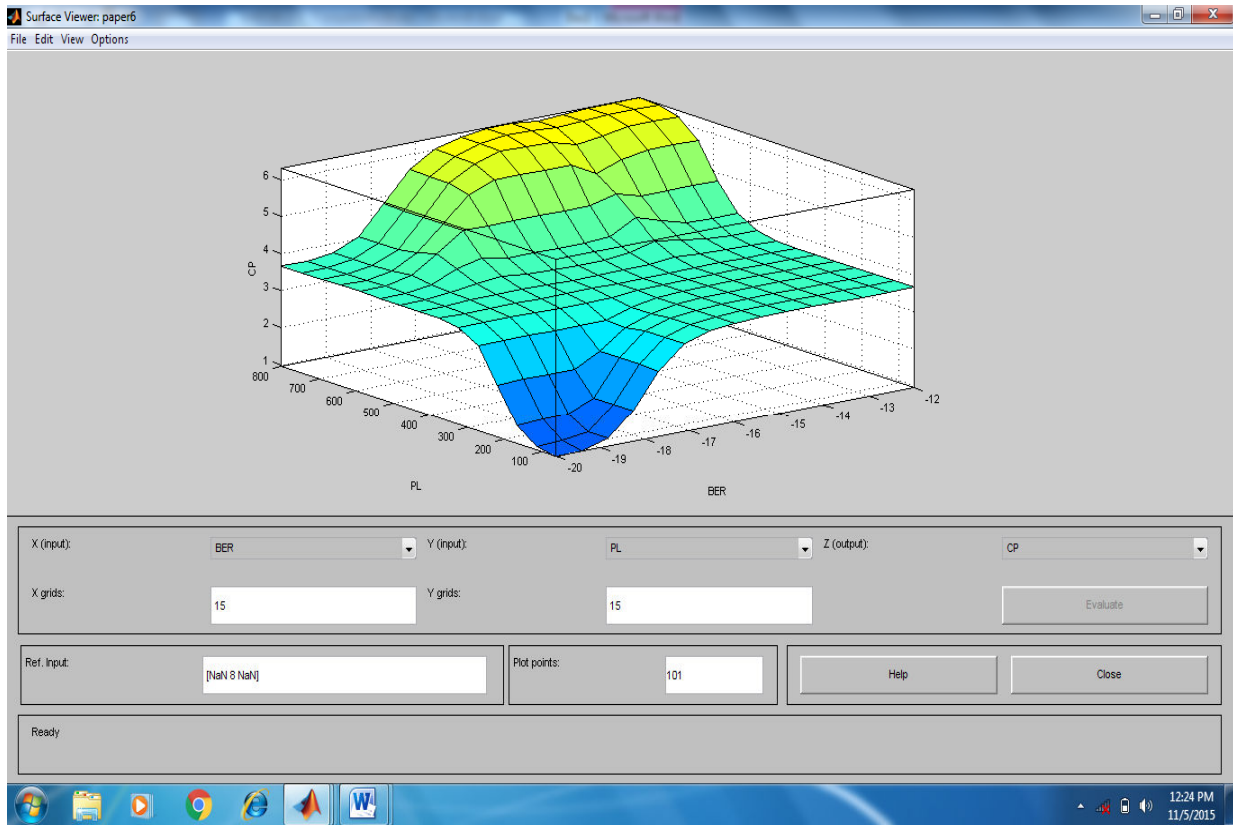

Fig. 8 3D- plot of input variables (BER & PL) vs. output variable (CP) fixing third input variable FCP at eight (8)

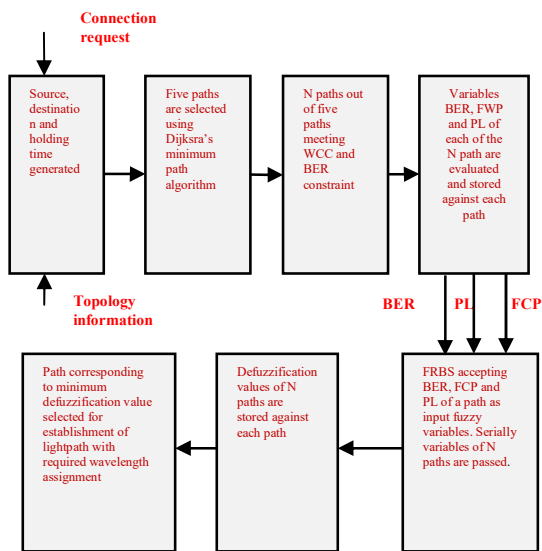

Fig. 9 Block diagram of execution of a connection request using proposed algorithm FWM-aware FDRWA

After defuzzification, the crisp output obtained is the cost function of the lighpath. The path corresponding to the minimum cost is selected for establishment of lighpath between the requested source and destination pair.

All the previous steps are repeated for different network loads, varying from 50 Erlangs to 110 Erlangs and for 50,000 requests for each load. In Table II, the linguistic variables for

input variables are 1) Very High (VH) 2) High (H) 3) Low (L).

In Table II, the linguistic variables for output parameters are 1) Excellent (E) 2) very good (VG) 3) good (G) 4) Poor (P) Rule number 8 states that IF BER is low and FCP is low and PL is high THEN CP is very good. Figs. 6-8 exhibit 3-D plot of any two input variables vs. output variable Cost, keeping the third input variable constant and the plots are compatible with the rules generated for FRBS.

V.RESULTS AND DISCUSSION

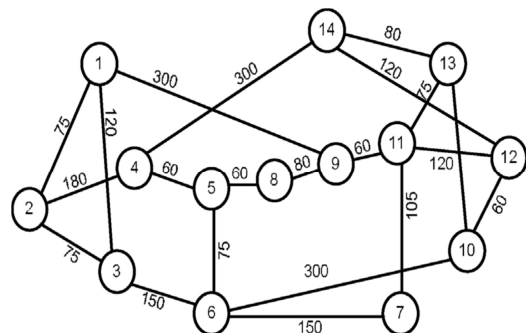

Fig. 10 Reduced version of NSFNET [1], [6]

In this work, a MATLAB Version of 7.5 with Intel (R) Core-Duo CPU (3.3 GHz) is used for simulation. In this paper, a 14node NSFNET topology is used as shown in Fig. 10 which, has 20 bi-directional links [1].

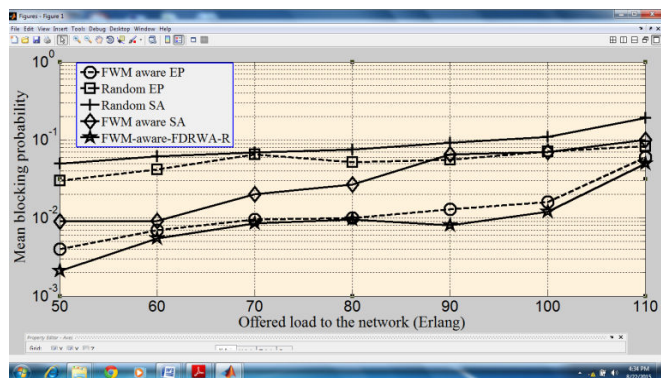

Fig. 11 Mean blocking probability for different network loads

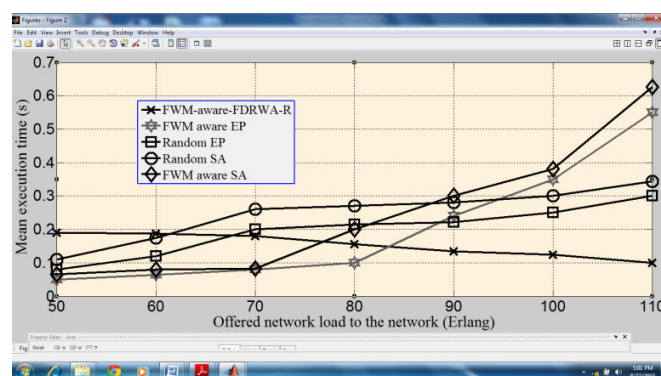

Fig. 12 Mean execution time for different network loads

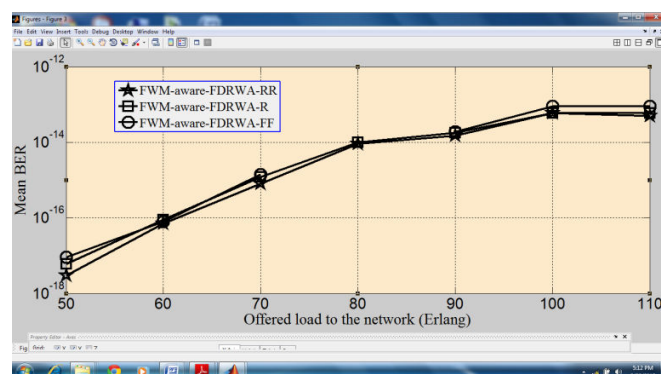

Fig. 13 Mean bit error rate (BER) for different network loads

Fig. 11 compares the mean blocking probability (MBP) obtained by the FWM aware EP and FWM aware SA with the proposed FWM-aware-FDRWA incorporating the random wavelength assignment technique. It is observed from the graph that the proposed algorithm exhibits lesser mean blocking probability for all the offered network loads, as the proposed algorithm used in this work incorporates the quality of service (QoS) parameters as well as quality of transmission (QoT) parameters for establishment of lightpath through the fuzzy rule based system (FRBS).

Fig. 12 compares the mean execution time (MET) obtained by the FWM aware EP and FWM aware SA with the proposed FWM-aware-FDRWA incorporating the random wavelength assignment technique. It is observed from the graph that the

MET for the proposed algorithm is less at higher traffic load compared to that at the lower traffic load. This is because at higher traffic load the average fuzzy processing time is reduced due to the less number of path/path is/are exported to the fuzzy system. At higher traffic load, the MET of FWM-aware-FDRWA can be compared with the MET of FWM-aware EP or FWM-aware SA and it is observed that at higher traffic load the proposed algorithm can also be used for real time applications [15].

Fig. 13 shows the graph of mean bit error rate (BER) of the proposed algorithm FWM-aware-FDRWA that utilizes first-fit (FF), round robin (RR) and random (R) wavelength assignment techniques. As is observed the mean BER is least at lower network load and increases with the network load as at lower network load, more paths are passed through the FRBS as compared to the higher network load.

VI. CONCLUSION

The proposed FWM-aware-FDRWA used in this paper is certainly powerful, dynamic and efficient as compared to that of FWM aware EP or FWM aware SA [1], [6]. The utilization of QoS network parameters such as average free channels per path (FCP), average path length (PL) and QoT parameter such as BER are used in the proposed FWM-aware-FDRWA, which consequently reduces the blocking probability and the average execution time. The significance of the proposed algorithm is that it can be used for real time applications even at higher traffic load [15].

REFERENCES

- [1] Bhanja, U., Mahapatra, S., Roy, R., FWM aware evolutionary programming algorithm for transparent optical networks, *Photonic Network Communications*, vol.23, no.3, 2012, pp.285-299.
- [2] Marsden, A., Maruta, A., Kitayama, K., "Reducing the lightpath establishing time of FWM-aware dynamic RWA for wavelength-routed optical networks," *Photonic Network Communications*, vol.18, 2009, pp.183-190.
- [3] Tan, S.C., Abbou, F.M., Ewe, H.T., Four wave mixing aware wavelength assignment using ant-based algorithm," *Journal of Applied Sciences*, vol.7, no.23, 2007, pp.3796-3800.
- [4] Marsden, A., Maruta, A., Kitayama, K., "Routing and Wavelength Assignment Encompassing FWM in WDM Lightpath Networks," *ONDM*, 2008, pp.128-133
- [5] Kaur, G., Singh, M.L., Patterh, M.S., "Theoretical investigations of the combined effect of fiber nonlinearities, amplifier and receiver noise in a DWDM transmission system," *Journal of Optical and Fiber Communications Research*, vol.6, no.1-10, 2009,
- [6] Bhanja, U., Mishra, D "Comparison of Metaheuristic Approach for impairment Aware Transparent optical network", *Proceeding of Ninth International Conference (IEEE) on Wireless and Optic Communication Networks, 2012 (WOCN2012)*, Indore, India (sept .2012)
- [7] Hwang, I.S; Lee, S. N; Chang, I. C; "Performance assessment of fuzzy logic control routing algorithm with different wavelength assignments in DWDM networks " *Journal of Information Science and Engineering*, vol.22, 2006, pp.461-473.
- [8] Hwang, I.S; Huang, I.F; Yu, S.C; "Dynamic fuzzy controlled algorithm for IP/GMPLS Over WDM networks" *Journal of Computer Science &Technology*, vol-20,no-5,Sept-2005, pp. 717-727.
- [9] Ramamurthy, B., Datta, D., Feng, H., Heritage, J. P., Mukherjee, B., "Impact of transmission impairments on the teletraffic performance of wavelength-routed optical Networks," *Journal of Lightwave Technology*, vol.17, no.10, 1999, pp.1713-1723.
- [10] Bhanja, U., Mahapatra, S., Roy, R.; "An evolutionary programming algorithm for survivable routing and wavelength assignment in

- transparent optical networks, International Journal of Information Sciences,” Elsevier publisher.vol.222, 10th Feb, 2013, pp.634-647.
- [11] Deng, Y; Chen, Y; Zhanga, Y; Mahadevan, S; “Fuzzy Dijkstra’s algorithm for shortest path problem under uncertain environment, “Applied Soft computing 12 (2012), pp.1231–1237
- [12] H. Zang, J. P. Jue, and B. Mukherjee, “A Review of Routing and Wavelength Assignment Approaches for Wavelength-Routed Optical WDM Networks,” Optical Network Magazine, vol.1, no. 1, Jan.2000,pp.47-60.
- [13] Sahu, P. P., “A new shared protection scheme in optical network,” Current Science, vol.91, no.9, 2006, pp. 1176-1183.
- [14] Amirthavalli, M., Fuzzy Logic and Neural Network, Scitech Publisher, 2004.
- [15] Ramjee, R., Murakami, K., Buskens, R.W., Lin, Y-J., La porta, T.F., “Design, Implementation, and Performance of a Cluster Mobile Switching Center,” *Wireless Multimedia Network Technologies*, R. Ganesh, K. Pahlavan, Z. Zvonar Ed., *The International Series in Engineering and Computer Science*, Springer, USA, 2006.