

Numerical Simulation of Liquid Nitrogen Spray Equipment for Space Environmental Simulation Facility

He Chao, Zhang Lei, Liu Ran, Li Ang

Abstract—Temperature regulating system by gaseous nitrogen is of importance to the space environment simulator, which keeps the shrouds in the temperature range from -150°C to $+150^{\circ}\text{C}$. Liquid nitrogen spray equipment is one of the most critical parts in the temperature regulating system by gaseous nitrogen. Y type jet atomizer and internal mixing atomizer of the liquid nitrogen spray equipment are studied in this paper, 2D/3D atomizer model was established and grid division was conducted respectively by the software of Catia and ICEM. Based on the above preparation, numerical simulation on the spraying process of the atomizer by FLUENT is performed. Using air and water as the medium, comparison between the tests and numerical simulation was conducted and the results of two ways match well. Hence, it can be concluded that this atomizer model can be applied in the numerical simulation of liquid nitrogen spray equipment.

Keywords—Space environmental simulator, liquid nitrogen spray, Y type jet atomizer, internal mixing atomizer, numerical simulation, fluent.

I. INTRODUCTION

SPACE environmental simulation facility is an effective way to forecast, test and certify the performance and the reliability of the spacecraft [1]. At present liquid nitrogen was chosen as the medium of deep cold environment in the area of the space environmental simulation, but when the environment temperature obviously changes by time, dynamic orbit environmental simulation is necessary. To regulate the temperature of the shrouds, the temperature regulating system by gaseous nitrogen spray equipment. One of the methods is shrouds temperature regulating system with liquid nitrogen spray equipment.

Liquid nitrogen is atomized into small droplets by the liquid nitrogen spray equipment, exchanges heat with the circulating gaseous nitrogen, chilling the gaseous nitrogen by latent heat and the liquid nitrogen is regulated by regulating the pressure of the gaseous nitrogen and liquid nitrogen, then the temperature can be regulated dynamically and precisely. And when the liquid nitrogen is atomized, the area of the droplet increases obviously, and the contact area increases, and the coefficient of the heat exchanging enhances and the consumption of the liquid nitrogen decreases.

He Chao, Zhang Lei, Liu Ran, and Li Ang are with the Beijing Institute of Spacecraft Environment Engineering, Beijing, China (phone: +8613581701546, +8615810534086, +8618612438410, +8613811565910; e-mail: hechao85112@126.com).

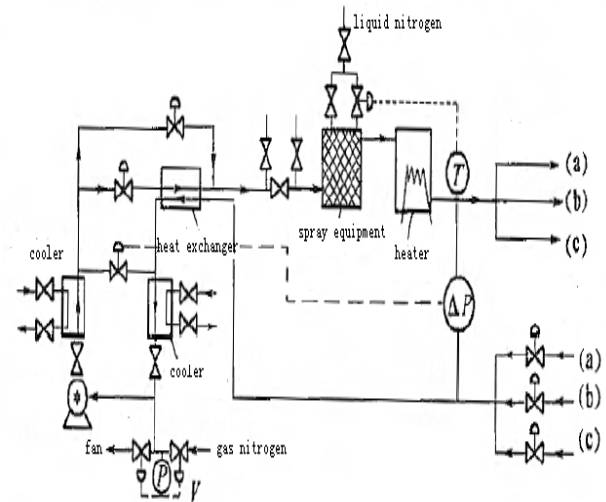

Fig. 1 Flowchart of the temperature regulating system by gaseous nitrogen

II. THE TYPE OF THE ATOMIZER

The Y type jet atomizer and the internal mixing atomizer are introduced in this paper, seen in Figs. 2 and 3 [2]. Y type jet atomizer is a kind of half internal mixing atomizer with high pressure airflow, with characteristics such as simple configuration, excellent atomized quality, wide temperature range to regulate etc. There is a mixing room in the internal mixing atomizer, the liquid nitrogen is atomized first time in the mixing room and sprayed into the environment as the second atomization, with the characteristics such as uniform droplet distribution etc.

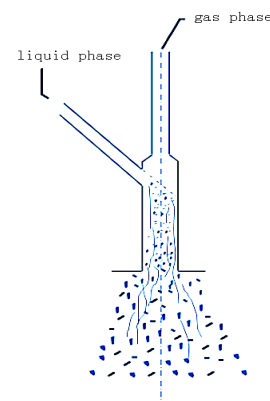

Fig. 2 Y type jet atomizer

III. MODELING

A. Mathematical Modeling

The process that the liquid nitrogen is spray through the atomizer and the droplet vaporizes in the liquid nitrogen heat exchanger is a kind of gas-liquid two-phase flow [3]-[6]. At present there are two numerical methods to analyze the two-phase flow: First is Euler-Euler method, the flow and the droplet are seen as continuous medium, and divided into

different parts base on the droplet size, and every part is seen as continuous medium, and suppose that every part's speed and temperature distribution is continuous; Second is Euler-Lagrangian method, in which the flow is seen as continuous phase, and the droplet is seen as discrete phase, analyze the droplet dynamics and the track, the modeling bases on the Monte-Carlo method, and simulate the droplet moving track by the Lagrangian Equation.

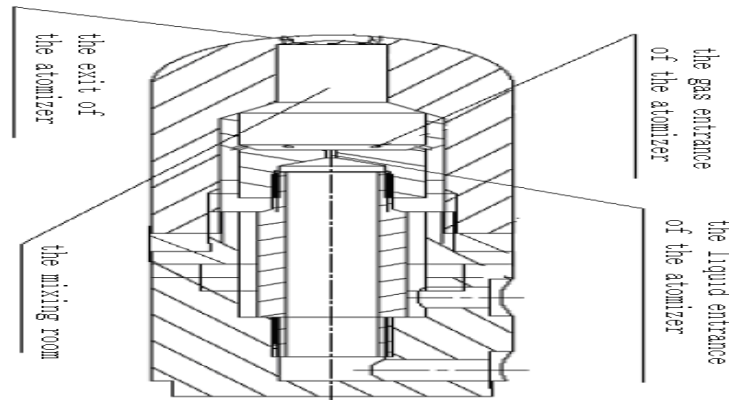

Fig. 3 Internal mixing atomizer

Euler-Lagrangian method is applied in this paper. DPM (Discrete Particle Model) model is applied. Base on the continuous flow, simulate the discrete phase moving track under the Lagrangian coordinate, compute the effect to the discrete phase moving track and continuous flow by the discrete phase orbit, heat exchanging between continuous phase and discrete phase. Moreover, DPM model supports the simulation such as droplet impact, and the fragmentation evaporation, and comprise several usual atomizer model.

The equation under the Descartes coordinate is (X direction):

$$\frac{du_p}{dt} = F_D(u - u_p) + \frac{g_x(\rho_p - \rho)}{\rho_p} + F_x \quad (1)$$

where F_D is unit mass force of the droplet:

$$F_D = \frac{18\mu C_D Re}{\rho_p d_p^2 24} \quad (2)$$

where u is the speed of the continuous phase, and u_p is the speed of discrete phase; And ρ is the density of the continuous phase, and ρ_p is the density of the discrete phase; And d_p is the diameter of the droplet, and Re is the Reynolds numbers of the droplet.

$$Re = \frac{\rho d_p |u_p - u|}{\mu} \quad (3)$$

where C_D is drag coefficient,

$$C_D = a_1 + \frac{a_2}{Re} + \frac{a_3}{Re} \quad (4)$$

a_1, a_2, a_3 of spheroidal droplet are constants in the specified range of Re . C_D can be calculated by the following equation.

$$C_D = \frac{24}{Re} (1 + b_1 Re^{b_2}) + \frac{b_3 Re}{b_4 + Re} \quad (5)$$

where;

$$b_1 = \exp(2.3288 - 6.4581\phi + 2.4486\phi^2) \quad (6)$$

$$b_2 = 0.0964 + 0.5565\phi \quad (7)$$

$$b_3 = \exp(4.905 - 13.8944\phi + 18.4222\phi^2 - 0.2599\phi^3) \quad (8)$$

$$b_4 = \exp(1.4681 + 2.2584\phi - 20.7322\phi^2 + 15.8855\phi^3) \quad (9)$$

The shape factor can be calculated by:

$$\phi = \frac{s}{S} \quad (10)$$

where s is the superficial area spheroidal droplet which has the same volume with the actual droplet, and S is the superficial area of the actual droplet.

The track of the droplet can be obtained by:

$$u_p = \frac{dx}{dt} \quad (11)$$

B. The Mesh of the Atomizer

Found the calculation model of the Y type jet atomizer by CATIA, and generate the mesh by ICEM, and the hexahedral

mesh is applied as seen in Fig. 4.

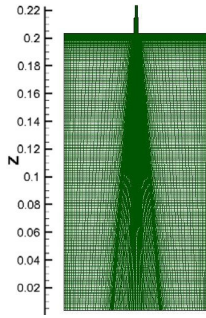

Fig. 4 (a) The whole mesh of the Y type jet atomizer

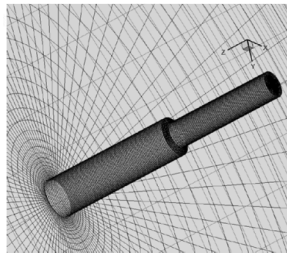

Fig. 4 (b) Part mesh of the Y type jet atomizer

IV. THE RESULT OF THE CALCULATION

As a matter of convenience, the operating mode in the following paper is described in the form of gas pressure-liquid pressure, for example the operating mode in which the gas pressure is 0.7 MPa and the liquid pressure is 0.6MPa is described as 0.7-0.6. To verify the feasibility of the numerical simulation result by comparing to the test result, the air and the water are chosen as the medium.

A. The Calculation Result of the Continuous Phase

The distribution of the speed of the only continuous flow is of well symmetry before the discrete phase is joined, as seen in Fig. 5 [7]. The gas is sprayed out of the atomizer at a high speed, and the speed decreased gradually from inside to outside. The distribution of the gas speed of part of the atomizer can be seen in Fig. 6.

Fig. 7 is vector figure at the $y=0$ face, the high speed shoot flow at the center of the flow causes an effect of rolling and absorbing, and the backflow is formed. The highest speed is at the entrance of the mixing part, where the area of high speed and low pressure is formed because the compressed gas expands fast as the expansion of the atomizer.

B. The Calculate Result of the Discrete Phase

The speed distribution of the Y type jet atomizer when the droplets are joined can be seen in Fig. 8. The droplet joined disturbed the flow of the exit of the atomizer, as the droplets at the exit of the atomizer are densest and block the gas. In addition, the speed of the flow decreases and fluctuates more acutely because of the droplet, and the speed of the flow decreases faster.

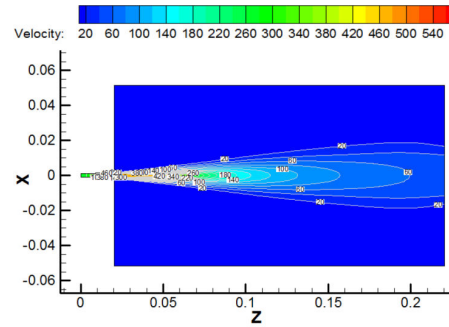

Fig. 5 The distribution of gas speed in the Y type jet atomizer at the $y=0$ face

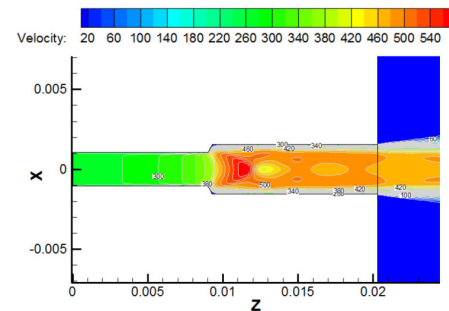

Fig. 6 The distribution of gas speed of the part of the Y type jet atomizer at the $y=0$ face

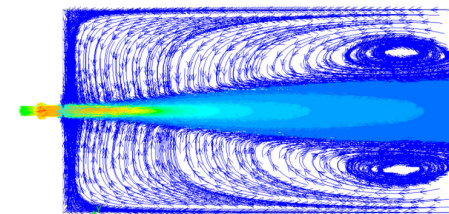

Fig. 7 The vector figure of the Y type jet atomizer at the $y=0$ face

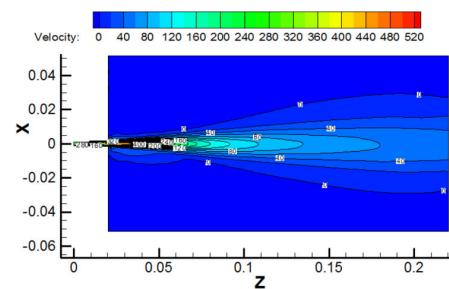

Fig. 8 The distribution of gas speed in the Y type jet atomizer at the $y=0$ face when the droplets are joined

The evaporation of the water is considered during the calculation, and the distribution of the mass fraction of the vapor can be seen in Fig. 9. The maximum value of the mass fraction of the vapor is at the two side of the exit of the atomizer, as the droplets at the exit of the atomizer are densest. The mass fraction of the vapor at the margin of the end of flow is 0 because of the backflow.

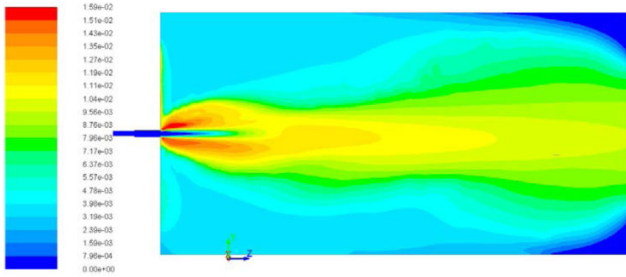

Fig. 9 The mass fraction of the vapor of the Y type jet atomizer at the $y=0$ face

V. COMPARISON WITH THE EXPERIMENT RESULT

A. The Comparison of the Atomizing Angle

The atomizing area is formed by the atomization of the liquid phase, and the angle of the edge is atomizing angle as seen in Fig. 10. The calculation result and the experiment result fit well at the 0.3-0.2 operating condition and the atomizing angles are both about 20° .

B. The Comparison of the Droplet Distribution

The distribution of the droplet volume can be seen in Fig. 11. Though the maximum value of the calculation result left shifts compared to the experimental data, the result of the calculation and the experiment fit well, especially at the low pressure operating condition.

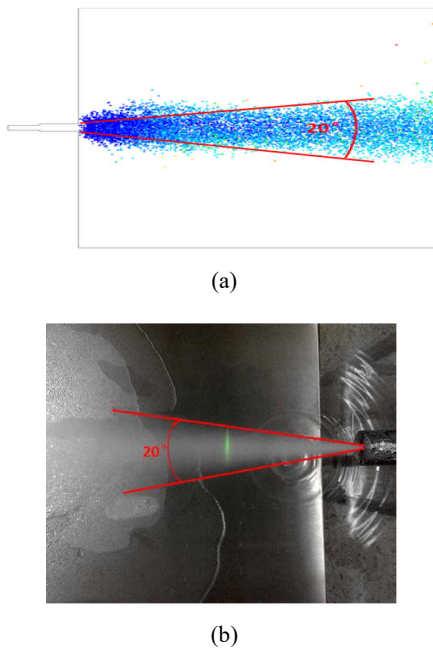

Fig. 10 The comparison of the atomizing angle at the 0.3-0.2 operating condition: (a) The numerical result, (b) The test result

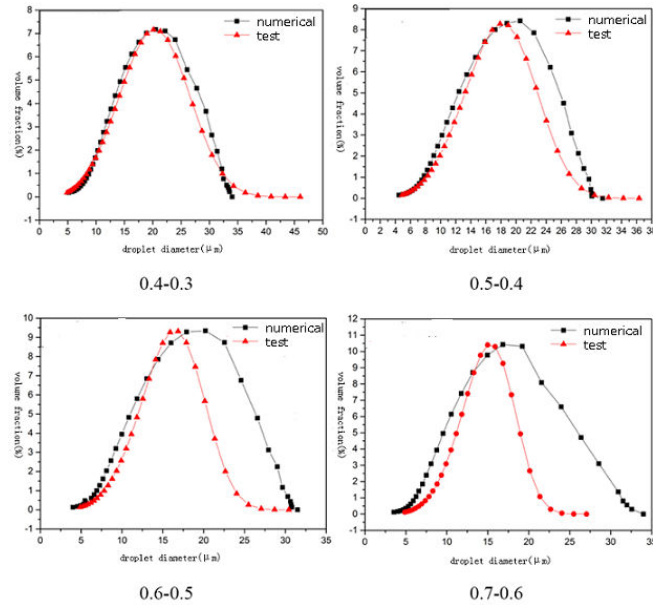

Fig. 11 The distribution of the volume fraction

VI. CONCLUSION

Liquid nitrogen spray equipment is the main part of the temperature regulating system by gaseous nitrogen, in which the property of the atomizer directly influences the property of the liquid nitrogen spray equipment. Two kinds of atomizer are introduced in this paper—Y type jet atomizer and internal mixing atomizer. The study of the Y type jet atomizer is focused by numerical simulation and tests. The air and the water are chosen as the medium. The comparison of the atomizing angle and the distribution of the volume fraction at different operating condition between the tests and numerical simulation were conducted and the results of two ways match well especially at lower pressure operating condition. So the atomizer model can be applied in the numerical simulation of liquid nitrogen spray equipment.

REFERENCES

- [1] Huang Ben Cheng, Ma You Li. Technology of space environment test (M). Beijing: National Defense Industry Press, 2002.
- [2] Cao Jian Ming. The study of the atomization (M). Beijing: Mechanical industry Press, 2005.
- [3] Yang Shi Ming, Tao Wen Quan. Heat Transfer (M). Beijing: Higher Education Press, 1998.
- [4] Tao Wen Quan, Numerical Heat Transfer (M). Xian: Xian Jiaotong University Press, 2001.
- [5] J. Kim, Spray cooling heat transfer. The state of the art (J). International Journal of Heat and Fluid Flow, 2007, 28(4):753-767.
- [6] A. H. Lefebvre, Effervescent atomizer operation and spray characteristics (J). Atomization and sprays.
- [7] Zhou Jun Jie. Engineering technology and applying example of Fluent (M). Beijing: China water conservancy and hydroelectric Press, 2010.