

Composite Patch Repair of Central Crack Growth in Aluminium Alloy Plate

S. Lecheb, A. Chellil, H. Mechakra, A. Zeggane, H. Kebir

Abstract—In this work, repaired crack in 6061- T6 aluminum plate with composite patches presented, firstly we determine the displacement, strain and stress, also the first six mode shape of the plate, secondly we took the same model adding central crack initiation, which is located in the center of the plate, its seize vary from 20 mm to 60 mm and we compare the first results with second. Thirdly we repair various cracks with composite patch (carbon/epoxy) and for (2 layers, 4 layers). Finally the comparison of stress, strain, displacement and six first natural frequencies between uncracked specimen, crack propagation and composite patch repair.

Keywords—Composite patch repair, crack growth, aluminum alloy plate, stress.

I. INTRODUCTION

FIBER reinforced polymer composite patches are adhesively bonded to a metallic structure as a repair method to either restore the load carrying capacity of a cracked. This patch forms a composite component consisting of the metal structure, the composite patch, and an adhesive which bonds the two together. The composite may be optimized to carry load in one direction with only 0° plies, or it may provide reinforcement in multiple directions by including plies of other orientation, typically 45°, 90°, or interwoven. The adhesive transfers loads between metal and composite and provides a stiff connection due to its large area for load transfer, despite its own relatively low stiffness [1]. Despite these disadvantages, bonded composite repairs to metallic structures are being applied in an increasingly broad spectrum of disciplines, including aerospace, naval, and civil engineering [2], [3]. An area of particular concern in the continued strength and performance of a composite bonded repair is the effect of impact damage on a structure. A low-velocity impact, such as a tool drop, can cause visually undetectable fatigue to a composite's interior structure that can initiate crack. Low-velocity impact fatigue may take the form of matrix cracking, fiber breakage, or delaminating between plies. Delaminating in particular can drastically reduce the composite's load-carrying capacity, especially in compression, as susceptibility to buckling is increased with the separation of the plies [4]. This strength reduction from damage also hampers the patch's effectiveness in transferring and carrying loads from the damaged metal underneath.

S. Lecheb is with the Laboratory of Engines Dynamics and Vibroacoustics, University of Boumerdes, Algeria (e-mail: samir_lecheb@yahoo.fr).

A. Nour and A. Chellil are with the Laboratory of Engines Dynamics and Vibroacoustics, University of Boumerdes, Algeria.

H. Kebir is with the Laboratory Roberval, University of Technology Compiègne, UTC, France.

Similarly, an impact may create a disband between the composite and steel layers by damaging the adhesive layer. Patches used to repair cracked composite structure are classified into two categories: internal patch and external patch. In external patches, the patches are adhered to the outer surface of the damaged area; different geometric shapes are used to cover more area damaged. We encounter patches circular, square, rectangular, elliptical, hexagonal, etc. ... [5], [6]. About internal patches are used to replace the damaged area subtracted from the structure, using the form of the latter. Reference [7] depending on the condition of the material, composite repair patches can also be classified into two types: hard patches and patches soft. Soft patches or drives are solidified before their implementation. Soft patches are applied to the uncured state. Solidification is carried out after setting place on the structure. Note that the characteristics of composite patches vary significantly specifications according elementary fold and the stacking sequence of the composite used. In the literature [8], we regency three typical methods for repairing composites by bonding patches. The external patch repair involves inserting a plug in the area cleaned and then applies a layer of glue and a patch outside. This method requires little preparation. Its implementation is simple and fast. By cons, repair induces an increase in the thickness there of course, the quality of the repair depends greatly the quality of the bonded joint. A combination of shear, axial and normal loads or each individually, peel and cleavage loading make up the primary loads acting on the adhesive bonds. A good repair must be effective in minimizing their effects. While designing a patch, the following issues need to be addressed. The overlap length has been shown to have a pronounced effect on the joint strength. With short overlap length adhesive material is subjected to high shear. It is, therefore recommended that a patch length of 80–100 times the repair thickness be used [9]. However, this is also subject to the necessary considerations for various effects such as imperfect bonding; patch delaminating and environmental effect etc. The adhesive properties influence the strength of the joint since the load is transferred from the skin to the patch via the adhesive. Reference [10] found that using adhesive materials with high shear properties produces stronger joints; however the ultimate adhesive shear strain affects the joint strength more than the ultimate adhesive shear stress. High stresses developed at the ends of the overlap need to be taken care of. Also, it is important to keep in mind that good adhesive bonds can be produced only in a small range of thickness since thick bonds tend to be porous and weak while ultra thin bonds are too stiff and brittle [11]; thus, thickness of adhesive layer is also an

important issue while designing a patch. Thin adhesive layers are shown to perform better than thick layers because with increase in adhesive thickness the patch gets softer. But thickness provides good durability to the entire patch as thick adhesive layer attracts lesser strains. The stiffness of adhesive is another important issue that needs to be addressed. Stiffer adhesives perform better. But if the adhesive is very stiff there is a danger for the patch reaching the yield point earlier than usual. It is reported that doubling the adhesive thickness has very little effect on the reduction of stress intensity factor or on maximum fiber stress, but it significantly reduces the peaks in shear stress in the adhesive.

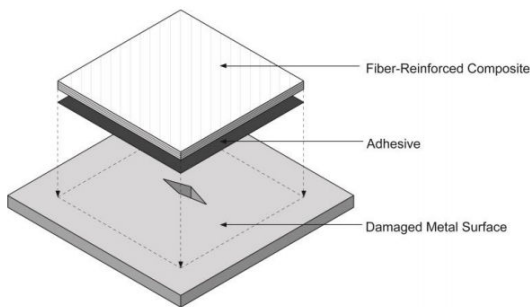

Fig. 1 Anatomy of a composite patch

II. SPECIMEN DESIGN

Geometry of the cracked structure in the present work is shown in Fig. 1. It was considered a 6061-T6 aluminum alloy plate; a through thickness crack is used to simulate the defect in the structural components.

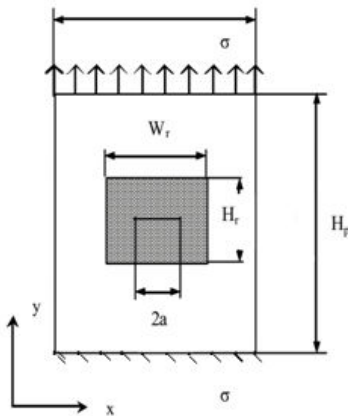

Fig. 2 Geometrical model of the plate

The size of the panel is: $H_p = 180$ [mm], $W_p = 180$ [mm] and thickness $t_p = 8$ [mm]. The central crack has a length $2a = 40$ [mm] repaired by carbon epoxy composite patch bonded with adhesive having an estimated thickness $t_a = 1$ [mm]. The height and width of the patch are $H_r = 40$ [mm] and $W_r = 60$ [mm], respectively. In this case we will create the model take into account the crack which is located in the center of the specimen:

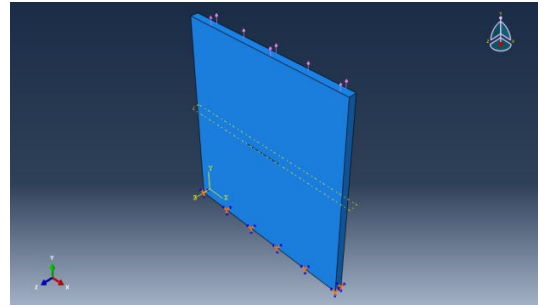

Fig. 3 Specimen

III. RESULTS OF CRACKED SPECIMEN

Von Mises stress: $S_{MAX} = 3.279 \times 10^2$ MPa

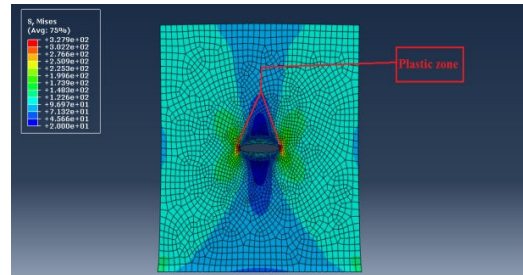

Fig. 4 Von Mises stress for cracked plate.

Displacement: $U_{max} = 2.875 \times 10^{-1}$ mm

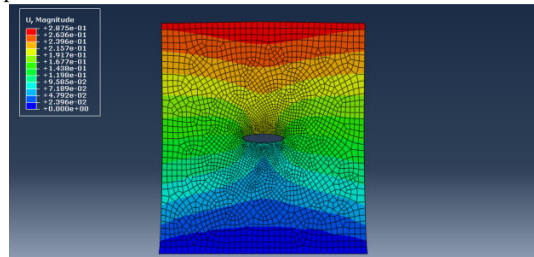

Fig. 5 Max displacement for cracked plate

Strain: $E_{max} = 4.846 \times 10^{-3}$

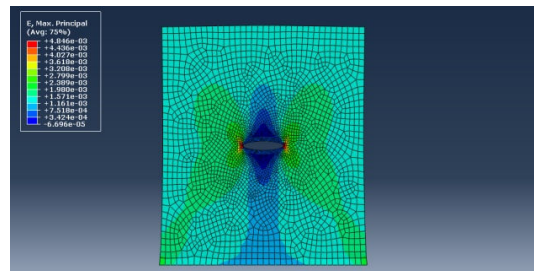

Fig. 6 Max deformation for cracked plate

Modes shapes:

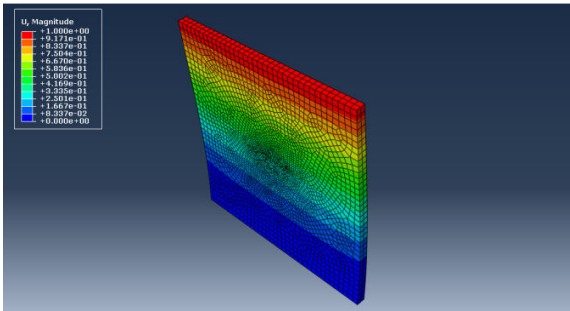

Fig. 7 1st mode $U_{max}=1.000e+00$ mm Freq = 5.6995Hz

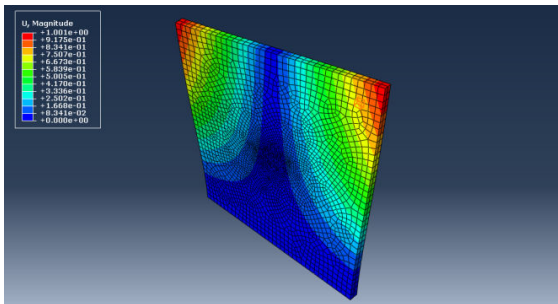

Fig. 8 2nd mode shape $U_{max}=1.001e+00$ mm Freq = 13.722Hz

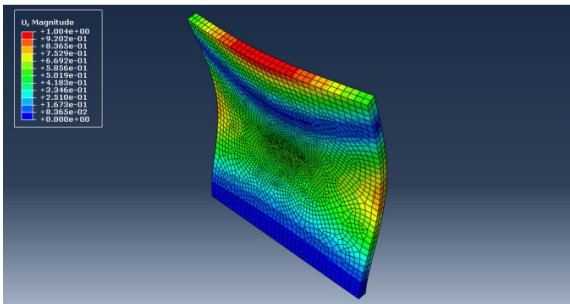

Fig. 9 3rd mode shape $U_{max}=1.004e+00$ mm Freq = 33.703Hz

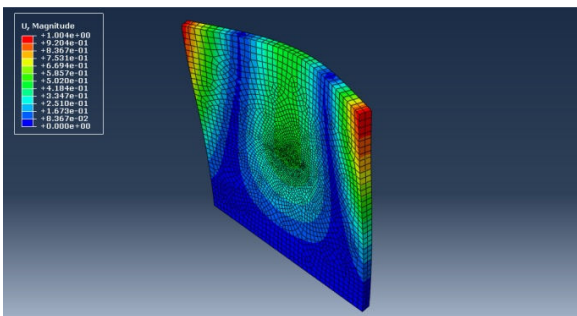

Fig. 10 4th mode shape $U_{max}=1.004e+00$ mm Freq = 43.743Hz

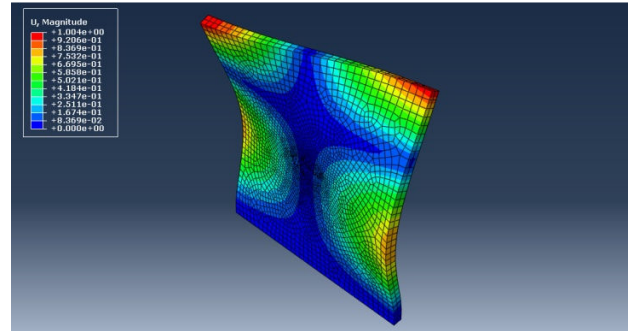

Fig. 11 5th mode shape $U_{max}=1.004e+00$ mm Freq = 49.854Hz

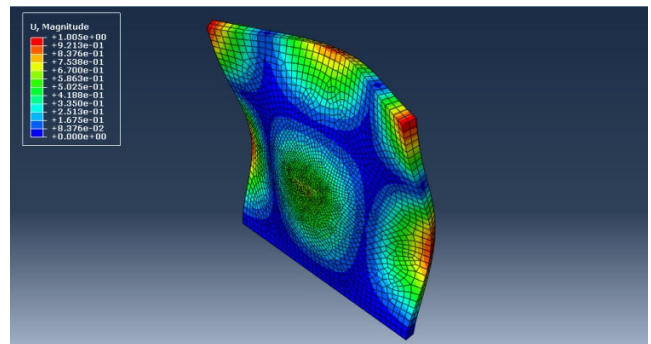

Fig. 12 6th mode shape $U_{max}=1.005e+00$ mm Freq = 84.735Hz

Comparison is given in the subsections below.

A. Modes Shapes

TABLE I
 COMPARISON OF MAXIMUM DISPLACEMENT (U), STRESS (S) AND MAXIMUM DEFORMATION (E) WITH AND WITHOUT CRACK

	S (MPa)	E	U (mm)
Plate without crack	138.4	2.095×10^{-3}	0.2621
Plate with crack of 20(mm)	237.9	3.415×10^{-3}	0.2639
Plate with crack of 40(mm)	327.9	4.846×10^{-3}	0.2875
Plate with crack of 60(mm)	435.3	6.424×10^{-3}	0.3294

We deduce in Table I that the displacement max and the deformation max increase but the stress increase with very important value because we have concentration of stress at crack-tip.

TABLE II
 COMPARISON OF NATURAL FREQUENCIES WITHOUT CRACK AND WITH DIFFERENT CRACK

Modes (HZ)	F1	F2	F3	F4	F5	F6
	(Hz)	(Hz)	(Hz)	(Hz)	(Hz)	(Hz)
Plate without crack	2.65	7.71	8.73	13.23	15.11	18.21
Plate with crack of 20(mm)	5.75	13.72	34.76	44.37	49.89	86.33
plate with crack of 40(mm)	5.74	13.74	34.47	44.18	49.89	85.87
plate with crack of 60(mm)	5.69	13.72	33.70	43.74	49.85	84.73
Plate without crack	5.62	13.70	32.49	43.20	49.74	83.43

We notice that the frequencies are decreasing after the increase of cracks. In addition, this decreasing is not linear.

IV. COMPOSITE PATCH REPAIR OF SPECIMEN

The composite patch was composed of a carbon/epoxy, for Composite patch with 2 layer (45 – (-45)) and for Composite patch with 4 layer (0° - 45° - (-45°) - 0°).

We see that the frequencies are increasing after the repair of cracks, the frequencies in 4 layers greater than the 2 layers. In addition, this increasing is not linear.

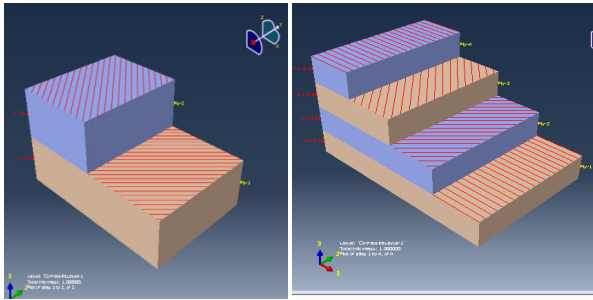

Fig. 13 Create composite layup

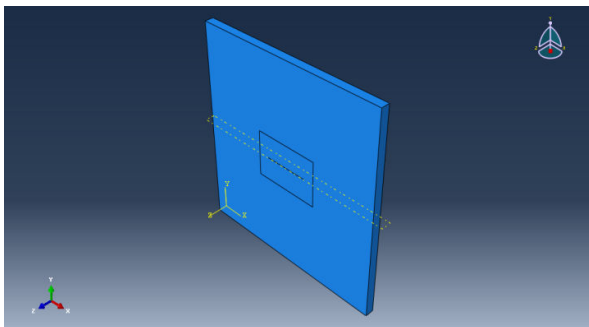

Fig. 14 Assembly of cracked plate with patch

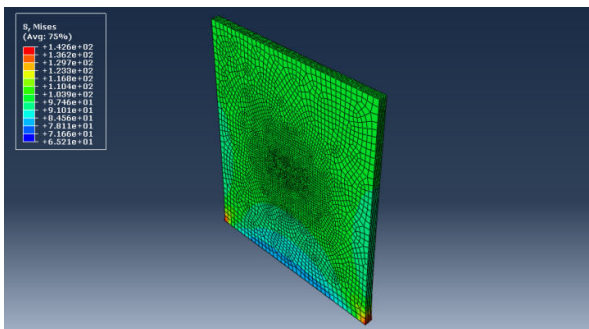

Fig. 15 Von Mises stress for cracked plate with patch.

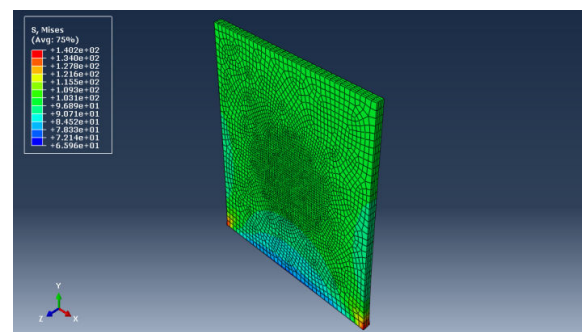

Fig. 16 Von Mises stress for cracked plate with patch.

TABLE III
 RESULT OF DISPLACEMENT, STRESS AND STRAIN

		S (MPa)	E	U (mm)
20	(2ply)	0.2622	2.131*10-3	141.6
	(4ply)	0.2622	2.104*10-3	139.95
40	(2ply)	0.2621	2.144*10-3	142.6
	(4ply)	0.2620	2.116*10-3	140.2
60	(2ply)	0.3039	3.694*10-3	247.6
	(4ply)	0.3012	3.661*10-3	245.2

TABLE IV
 NATURAL FREQUENCIES FOR DIFFERENT CRACK REPAIRED BY PATCH

a (mm)	Ply	F1 (Hz)	F2 (Hz)	F3 (Hz)	F4 (Hz)	F5 (Hz)	F6 (Hz)
20	(2ply)	7.32	17.37	44.91	49.97	55.63	93.86
	(4ply)	7.49	17.80	45.91	51.29	57.16	93.87
40	(2ply)	6.43	15.33	38.81	49.53	55.59	92.72
	(4ply)	6.59	15.76	39.81	50.85	57.12	92.73
60	(2ply)	6.36	15.31	37.59	48.99	55.48	91.42
	(4ply)	6.52	15.74	38.59	50.31	57.01	91.43

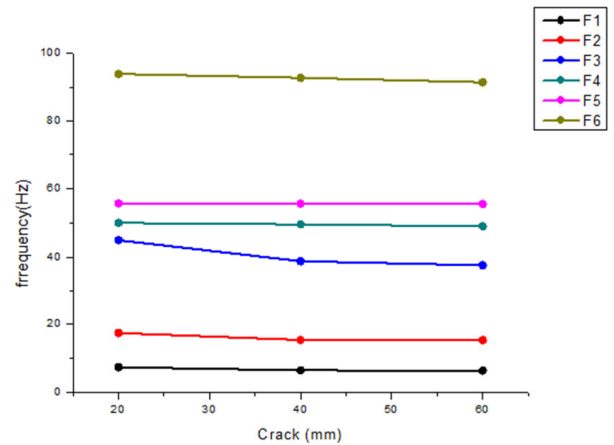

Fig. 17 Frequencies in function of crack size with patch of 2 ply

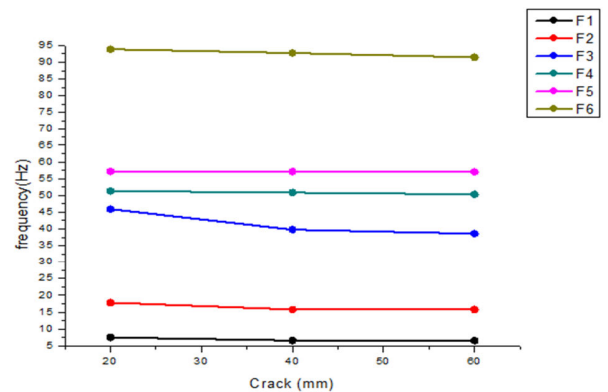

Fig. 18 Frequencies in function of crack size with patch of 4ply

We have two graphs of frequencies in function of crack size are nearly constant and we notice the frequencies with 4ply are higher than 2ply.

The variation of three parameters stress, strain and displacement as a function of crack size is shown in Fig. 19.

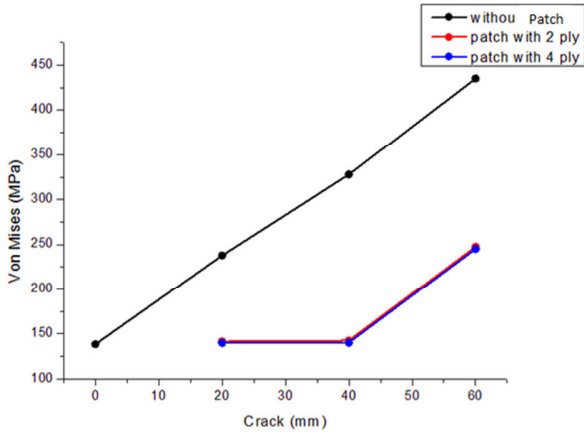

Fig. 19 Von misses stress evaluation.

We notice that the stress max increase after cracking, and decrease after patch repair, the repair with 4 ply has the greatest effect on reducing stress.

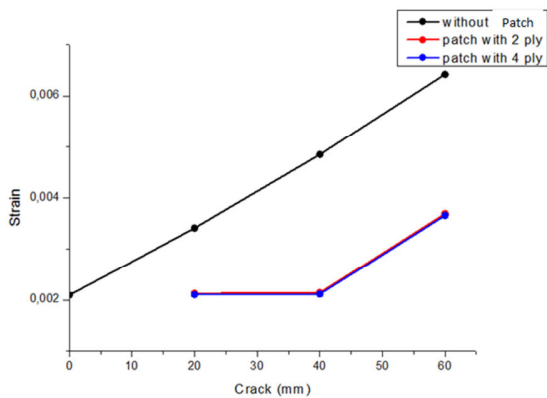

Fig. 20 Strain evaluation

The strain increase with crack size and we notice that the strain in the 4 ply model is less the 2 ply model.

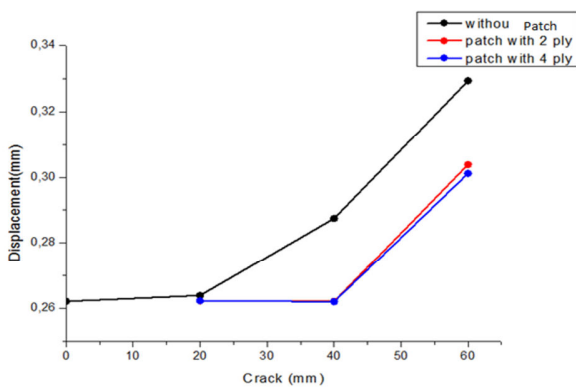

Fig. 21 Displacement evaluation

It can be seen that the displacement increases with the increase of crack size and it has a bigger values with no patch than with patch 2 and 4 ply.

V. CONCLUSION

In this paper we found the stresses, strain, mode shapes and their frequencies. We deduce that the maximum stresses are concentrated around of the crack size, and the natural frequencies decrease when the crack size increases. We notice between the part with 4 ply patch and the 2 ply patch, the first withstand better the stresses after repairing the crack. The work purpose of this study has been the determination of the effectiveness of bonded composite patches to repair cracked thin aluminum panels. The repair is realized by patching only one side of the panel in order to reduce the associated costs and time required, and we have define the composite patch, in order to give a broad view of the various components of a composite patch and their particular mechanical characteristic and the study of the mechanical behavior of this material.

REFERENCES

- [1] Baker, A.A., Introduction and overview, in *Advances in the bonded composite repair of metallic aircraft structure*, A.A. Baker, L.F. Rose, and R. Jones, Editors. 2003, Elsevier: Oxford, UK. p. 1-18.
- [2] Baker, A. and R. Jones, *Bonded repair of aircraft structures*. Vol. 7. 1988: Springer.
- [3] Hollaway, L. and J. Cadei, *Progress in the technique of upgrading metallic structures with advanced polymer composites*. *Progress in Structural Engineering and Materials*, 2002. 4(2): p. 131-148.
- [4] De Freitas, M. and L. Reis, Failure mechanisms on composite specimens subjected to compression after impact. *Composite Structures*, 1998. 42(4): p. 365-373.
- [5] J. Rodes, R. Brossier, X.-J. Gong, J. Rousseau. *Etude des performances des structures composites réparées*. *Matériaux 2006*, 13-17 November 2006, Dijon, France
- [6] A.C. Okafor, H. Bhogapurapu. Design and analysis of adhesively bonded thick composite patch repair of corrosion grind-out and cracks on 2024 T3 clad aluminum aging aircraft structures. *Composite Structures* 76 (2006) 138-150.
- [7] Chun H. Wang, Andrew J. Gunnion. On the design methodology of scarf to composite laminates. *Composites Science and Technology*, 68 (2008) 35-46.
- [8] Composite repair, HEXCEL Composites. April 1999, Publication No. UTC 102
- [9] G. Savage, M. Oxley. Repair of composite structures on Formula 1 race cars. *Engineering Failure Analysis*.
- [10] R. D. Adams and W. C. Wake. *Structural adhesive joints in engineering*. Elsevier applied science publishers Ltd 1984. ISBN 0 85334 263 6
- [11] Z. Hashin et B. W. Rosen (1964). The elastic module of fiber-reinforced materials. *J.Appl.Mech.* June, 223-232.