

# Error Correction of Radial Displacement in Grinding Machine Tool Spindle by Optimizing Shape and Bearing Tuning

Khairul Jauhari, Achmad Widodo, Ismoyo Haryanto

**Abstract**—In this article, the radial displacement error correction capability of a high precision spindle grinding caused by unbalance force was investigated. The spindle shaft is considered as a flexible rotor mounted on two sets of angular contact ball bearing. Finite element methods (FEM) have been adopted for obtaining the equation of motion of the spindle. In this paper, firstly, natural frequencies, critical frequencies, and amplitude of the unbalance response caused by residual unbalance are determined in order to investigate the spindle behaviors. Furthermore, an optimization design algorithm is employed to minimize radial displacement of the spindle which considers dimension of the spindle shaft, the dynamic characteristics of the bearings, critical frequencies and amplitude of the unbalance response, and computes optimum spindle diameters and stiffness and damping of the bearings. Numerical simulation results show that by optimizing the spindle diameters, and stiffness and damping in the bearings, radial displacement of the spindle can be reduced. A spindle about 4  $\mu\text{m}$  radial displacement error can be compensated with 2  $\mu\text{m}$  accuracy. This certainly can improve the accuracy of the product of machining.

**Keywords**—Error correction, High precision grinding, Optimization, Radial displacement, Spindle.

## I. INTRODUCTION

THE precision spindles are widely used in high precision grinding machine tools. An important function when employing spindles equipped with precision angular contact bearings, radial displacement correction error can be achieved to these spindles by optimizing the shape of geometry, adjusting the preload and regulating the lubricant in the bearings [1]-[4].

This error compensation technique arises from the forced vibration of the grinding wheel caused by the unbalance mass. Many papers have reported that the system parameters such as diameter of the shaft, stiffness of the shaft and stiffness and damping of the bearings, the radial displacement of the shaft could be reduced [5], [6]. As an illustration the spindle with the initial radial displacement error of 32  $\mu\text{m}$ , has the optimum radial displacement about 2  $\mu\text{m}$  [7] when mounted on an optimized bearing.

Khairul Jauhari is with the University of Diponegoro, Semarang, Indonesia (phone: +62 815 65 45792; e-mail: khairul.j4uhari@gmail.com).

Khairul Jauhari is with the Agency for The Assessment and Application of Technology (BPPT), Center for Machine Tools, Production & Automation, Tangerang Selatan, Indonesia (phone: +62 21 702 86019; e-mail: khairul.jauhari@bppt.go.id).

Achmad Widodo and Ismoyo Haryanto are with the University of Diponegoro, Semarang, Indonesia (e-mail: awidodo2010@gmail.com, ismoyo2001@yahoo.de).

The high stiffness in the bearings can be achieved by increasing the initial preload [3], enabling an optimal design to be achieved as in reference [7]. However, further investigations show that for an optimal performance not only the stiffness parameters of the bearing must be increased, but the bearing damping also should be adjusted [8].

In this paper, a high precision spindle shaft is modeled as a flexible rotor supported by two sets of angular contact ball bearing. Finite element method (FEM) was employed to build the spindle equation motion in order to describe the spindle dynamic. In this study, natural frequencies, critical speeds, and amplitude of unbalance response caused by residual unbalance are determined in order to investigate the spindle behaviors.

An optimization design technique was implemented in order to minimize the radial displacement of the spindle and computes the optimum values of spindle diameter and stiffness and damping of the bearings which considers shaft diameters, dynamic characteristics of the bearings, critical frequencies and amplitude of the unbalance response. Due to the complexity equation of the constraint and objective function, describing the critical speeds and unbalance response, a stochastic search method such as genetic algorithm (GA) [9] was employed for the computation of the diameter, stiffness, and damping. The optimum of spindle diameter and stiffness and damping of the bearings are obtained by raising the critical speeds and reducing the unbalance response of the assembly.

Simulation results show that by optimizing the spindle diameters, and stiffness and damping in the bearings for the optimum radial displacement, error correction of spindle displacement can be achieved in certain operating speed. As a simulation example result, an initial design of spindle radial displacement for operating speed at 8000 rpm has run-out error about 4  $\mu\text{m}$  can be compensated with 2  $\mu\text{m}$ .

## II. METHODS

### A. Rotating Spindle Model and Theory

Generally, the spindle-bearing system is considered as an assemblage of the discrete disks and bearings and the spindle segments with distributed mass. In order to obtain an accurate analysis of the complexity of the spindle-bearing system, the equation of motion for small vibrations is derived based on the procedure of the finite element discretization which can be found in many literatures [10]-[12], the details of these equations would not be derived here and only the general

equations of motion are shown below. The motion equations that describe the dynamic behavior of entire spindle-bearing system are formulated by taking into account the contributions from all elements in the model. The assembled equation of motion with  $N_e$  elements in the global coordinates is of the form [1]:

$$M \ddot{q} - C \dot{q} + K q = F \quad (1)$$

where  $M = (M_t + M_r)$  is the global mass matrix,  $M_t$  and  $M_r$  are the translational and rotational mass matrices,  $C = (-\Omega G + C_{br})$  and  $K = (K_b + K_s)$  are the global damping and stiffness matrices,  $\Omega$  is a constant rotating speed,  $G$  is the global gyroscopic matrix,  $K_b$ ,  $C_b$  are the stiffness and damping matrices of the bearing, and  $F$  is the global force vector acting on the shaft element, respectively.

### B. Analysis of Eigenvalue

In order to obtain the natural frequency of the system, then the eigenvalue must be solved and expressed by (1); the system equation can be set as a state variable vector.

$$A_m \dot{x} + B_m x = 0 \quad (2)$$

where the matrices of  $A$ ,  $B$ , and displacement  $x$  consist of element matrices given as

$$A_m = \begin{bmatrix} M & C \\ 0 & I \end{bmatrix}, \quad B_m = \begin{bmatrix} 0 & K \\ -I & 0 \end{bmatrix}, \quad x = \begin{bmatrix} \dot{q} \\ q \end{bmatrix}$$

For assuming harmonic solution  $x = x_0 e^{\lambda t}$  of (2), the solution of an eigenvalue problem is

$$(A_m \lambda + B_m) x_0 = 0 \quad (3)$$

where,  $\lambda$  is the eigenvalue. The eigenvalues are usually as the complex number and conjugate roots.

$$\lambda_k = \alpha_k \pm i\omega_k \quad (4)$$

where,  $\alpha_k$  and  $\omega_k$  are the stability factor of growth and the  $k$  is the mode of damped frequencies, respectively.

### C. Analysis of Unbalance Response

The forces of mass unbalance ( $F$ ) which is shown in (1) can be expressed as

$$F = F_u \Omega^2 e^{i\Omega t} \quad (5)$$

where, ( $F_u$ ) is the force which is independent of time and rotating speed. The unbalance response ( $A$ ) due to unbalance mass is considered to be as the form

$$A = A_u e^{i\Omega t} \quad (6)$$

Substituting (5) and (6) into (1), the equation can be expressed as

$$(K - \Omega^2 M + i\Omega C) A_u = F_u \Omega^2 \quad (7)$$

By solving (7) for  $A_u$ , the response of steady state can be obtained.

### D. Optimization Model

The optimization formulation model for error reduction of the radial displacement problem can be considered as vibration level optimization problem. The optimum values of spindle diameter and the stiffness and damping of the bearings are obtained by raising the critical speeds and reducing the unbalance response. For the formulation model, the objective function is to minimize the spindle mass  $M(Q)$  and the inequality constraints are subject to the non-linear function of the critical speeds and the unbalance responses. In this study, spindle diameters, and stiffness and damping of the bearings were selected as the design variables. As we have described above, the formulation model can be expressed as follows:

Minimize mass  $M(Q)$

$$\begin{aligned} \Omega_m(Q) &\geq \Omega_m^* \\ A_m(\Omega_m) &\leq A_m^* \\ Q_L &\leq Q \leq Q_U \end{aligned} \quad (8)$$

where,  $\Omega_m$  and  $A_m$  ( $m = \text{number of modes}$ ) are the new values of critical speeds and unbalance responses for the optimum model, and  $\Omega_m^*$  and  $A_m^*$  are the target constraint values of critical speeds and unbalance response for the initial model. Therefore, it means that the critical speeds,  $\Omega_m$ , should be increased above given initial values  $\Omega_m^*$ , and decreasing the unbalance response,  $A_m$ , below the given values  $A_m^*$ . Moreover, the upper ( $Q_U$ ) and lower ( $Q_L$ ) bounds on the design variables are set due to manufacturing constraint and to prevent the critical stress condition.

TABLE I  
 SEARCHING STRATEGY FOR GENETIC ALGORITHM (GA)

Strategy of input parameter	Description of values
Population size	20
Scaling function	Rank
Selection criteria	Stochastic uniform
Elite count	2
Crossover fraction	80%
Mutation probability	Constraint dependent
Constraint tolerance	$1 \times 10^{-6}$
Maximum generation	100

Due to the non-linearity and the complex functions of the critical speeds and the unbalance responses, the derivatives of these functions are very difficult to obtain. Therefore, a stochastic search optimization approach without derivatives such as genetic algorithm (GA) is employed to solve the optimization model, which is performed in MATLAB optimization Toolbox. Table I shows the strategy of input parameters for performing the process of genetic algorithm.

The flowchart, process of genetic algorithm for searching the optimum values of the objective function and design variables are described in Fig. 1.

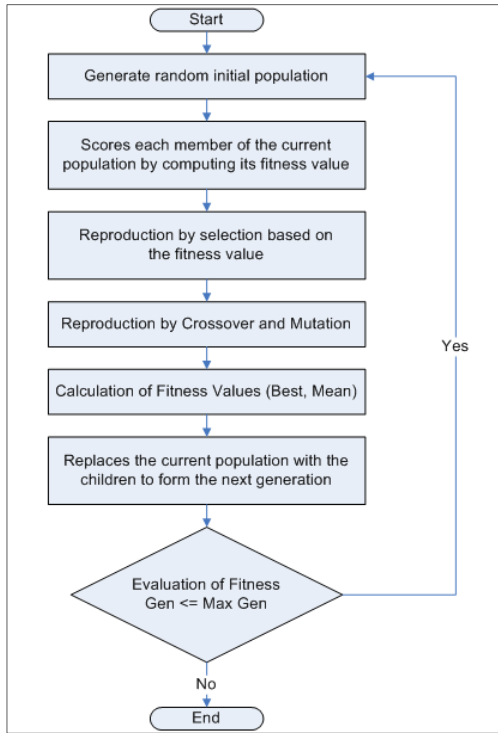

Fig. 1 Flowchart of genetic algorithm (GA)

### III. RESULTS AND DISCUSSION

In order to illustrate how the vibration level optimization design technique can be used to minimize the radial displacement of the spindle, an example of numerical simulation of this optimization problem was done. A schematic of the finite element model of the spindle is shown in Fig. 2. In this case, the spindle shaft is modeled into 17 beam elements with a node at both ends of the shaft element. The mass of grinding wheel and pulley can be considered as the four elements of the rigid disk which are located at node 1, 14, 15 and 16. In addition, the two sets of bearing are located at node 5 and 12, and the residual unbalance is assumed to occur at node 1.

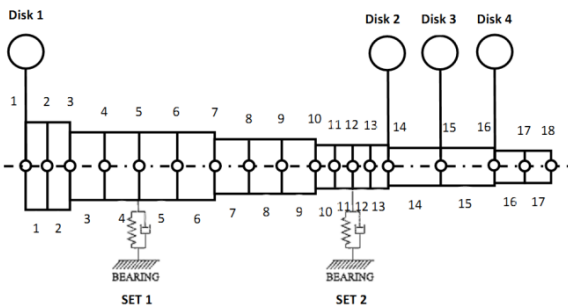

Fig. 2 Finite element model (FEM) of spindle system

In the case of vibration level optimization, the diameter of

the shaft elements,  $d_n$ , ( $n$  = element numbers), and stiffness and damping of the bearings,  $K_m, C_m$ , ( $m$  = 1, 2) are chosen as design variables. Thus, the design variables ( $Q$ ) for the spindle model can be written as:

$$Q = [d_1, d_2, \dots, d_{17}, K_1, K_2, C_1, C_2] \quad (9)$$

Due to the bearing dimension constraint, avoiding the critical stress and the stability of the optimization process is ensured then the upper and lower values on the shaft diameter need to be set. The lower and upper bounds on the diameter of the shaft elements are given by  $Q_L = 0.017$  m and  $Q_U = 0.106$  m except in the vicinity of the bearings there is no change of the shaft diameter due to limitations of the bearing size.

For solving the optimization problem, the first step is to determine the critical speeds in the main concern of operating speeds range, and then proceed to calculate the magnitude of the unbalance response caused by these critical speeds. These two things will give an overview about the vibration level of system behavior, and the responses with high amplitude chosen as a target value of the optimization process in which the amplitude needs to be reduced.

Initial simulation results show that, the spindle has two forward modes of the two first critical speeds, which are the first forward mode  $\Omega_{1F} = 11910$  rpm and the second forward mode  $\Omega_{2F} = 21120$  rpm, respectively. Due to the first forward mode has a small modal damping ratio ( $\zeta_{1F} = 0.05$ ), it may lead to a very high response peak as illustrated in Fig. 3. The values of critical speeds and maximum amplitude vibration at the first forward mode (1F) are

$$\Omega_{1F}^{(0)} = 11910 \text{ rpm}, A_{1F}^{(0)} = 5.032 \times 10^{-5} \text{ m}$$

For the optimization procedure, by substituting the original model values into (8), re-arranged can be written as

Minimize mass  $M(Q)$

$$\begin{aligned} \Omega_m(Q) &\geq \Omega_m^* = \Omega_{1F}^{(0)}, \\ A_m(\Omega_m) &\leq A_m^* = A_{1F}^{(0)}, \\ 0.017 &\leq Q \leq 0.106. \end{aligned} \quad (10)$$

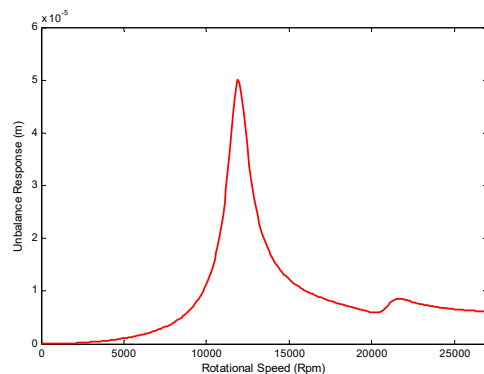

Fig. 3 Unbalance response of spindle system

For the optimization simulation, the numerical values are the initial mass ( $m$ ) = 3.6 kg, operating speed  $\Omega = 8000$  rpm

and initial values are  $d_1 \sim d_2 = 88$  mm,  $d_3 \sim d_6 = 70$  mm,  $d_7 \sim d_9 = 64.5$  mm,  $d_{10} \sim d_{13} = 60$  mm,  $d_{14} \sim d_{15} = 54.5$ ,  $d_{16} \sim d_{17} = 50.4$ ,  $K_1 = 1.911 \times 10^8$  N/m,  $K_2 = 2.476 \times 10^8$  N/m,  $C_1 = 191.1 \times 10^2$  N.s/m and  $C_2 = 247.6 \times 10^2$  N.s/m. The initial radial displacement in (7) is  $A = 4.152$   $\mu$ m when the allowance residual unbalance (ISO 1940 G1) is applied to the grinding wheel. In Figs. 4 and 5, the time response of the displacement in the y and z axis direction and absolute displacement of the spindle respectively before optimization are shown.

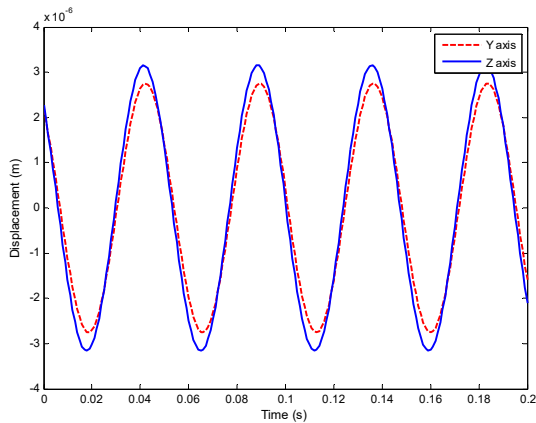

Fig. 4 Radial displacement in the y and z axis

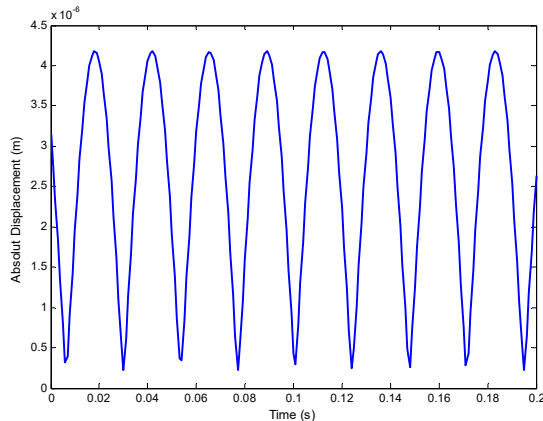

Fig. 5 Absolute radial displacement of spindle (before)

The optimum values of the spindle diameter and the stiffness and damping of the bearings which minimize the radial displacement of the spindle are shown in Tables II and III.

TABLE II  
 DIAMETER OF THE SPINDLE SHAFT

Diameter	Initial	Optimum
$d_1 \sim d_2$	88	88
$d_3 \sim d_6$	70	70
$d_7 \sim d_9$	64.5	60
$d_{10} \sim d_{13}$	60	60
$d_{14} \sim d_{15}$	54.5	54.5
$d_{16} \sim d_{17}$	50.4	17

TABLE III  
 DYNAMIC CHARACTERISTICS OF THE BEARING

Diameter	Initial	Optimum
Stiffness (N/m)		
$K_1$	$1.911 \times 10^8$	$3.797 \times 10^8$
$K_2$	$2.476 \times 10^8$	$3.240 \times 10^8$
Damping (N.s/m)		
$C_1$	$191.1 \times 10^2$	$192.8 \times 10^2$
$C_2$	$247.6 \times 10^2$	$249.3 \times 10^2$

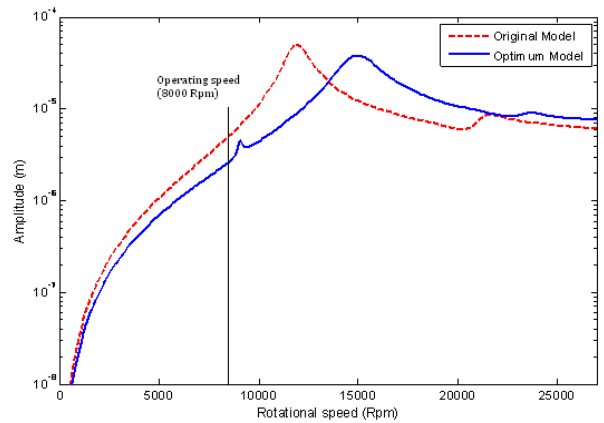

Fig. 6 Comparison of unbalance response

TABLE IV  
 OPTIMUM VALUES COMPUTED BY GA

Diameter	Initial	Optimum
Total mass of shaft $m$ (kg)	3.6	3.36
1 <sup>st</sup> critical speed $\Omega_{1F}$ (rpm)	11910	14838
Amplitude of unbalance response $A_{1F}$ (m)	$5.032 \times 10^{-5}$	$3.691 \times 10^{-5}$

The comparison of unbalance response at the grinding wheel due to the residual unbalance before and after optimization is shown in Fig. 6. It can be seen that the spindle diameter and the stiffness and damping of the bearings are effective to increase the critical speed and decrease the amplitude of the unbalance response at first mode (1F). The total shaft mass, the 1<sup>st</sup> critical speed and unbalance response for the initial and optimum model which is optimized by genetic algorithm (GA) are presented in Table IV.

The simulation result shows that, after optimizing the spindle shaft, and adjusting the bearings to an optimal stiffness and damping, which the allowance residual unbalance (1 gr.mm/kg) according to ISO 1940-1 G1 is applied to the grinding wheel, therefore the maximum radial displacement of the spindle for operating speed  $\Omega$  at 8000 rpm would be  $A = 2.328$   $\mu$ m as illustrated in Fig. 6. In Figs. 7 and 8 the time response of the displacement in the y and z axis direction and absolute displacement of the spindle after optimization are shown respectively. In Fig. 8, the absolute displacement of the spindle shows a great reducing, about 43.93% in the amplitude when compared with Fig. 5. This certainly can improve the accuracy of the product of machining.

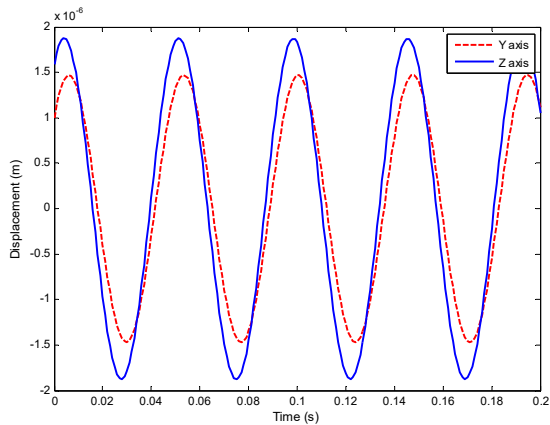

Fig. 7 Radial displacement in the y and z axis (optimized)

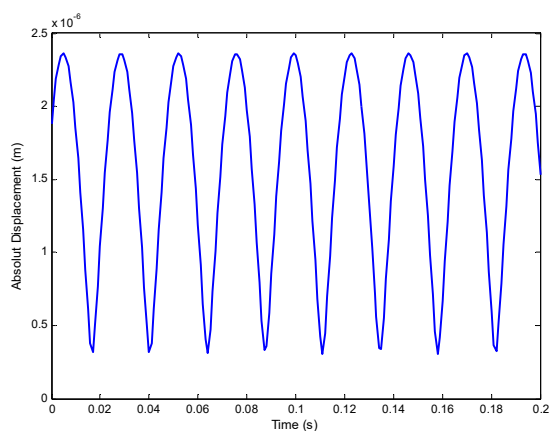

Fig. 8 Absolute radial displacement of spindle-bearing (optimized)

#### IV. CONCLUSION

An optimization design technique such as vibration level optimization has been implemented successfully in order to minimize the radial displacement of the spindle. In this study, the vibration level optimization model was applied to find the spindle diameter and the stiffness-damping of the bearing optimum values by raising the critical speeds and reducing the unbalance response. The objective of this optimization problem is only to minimize the spindle mass under critical speed and unbalance response constraint. Simulation results show that the radial displacement of the spindle for operating speed  $\Omega$  at 8000 rpm was reduced satisfactory, about 43.93% when optimizing the spindle shaft, and adjusting the dynamic characteristics of the bearing to an optimal stiffness and damping. This certainly can improve the accuracy of the machining process.

#### REFERENCES

[1] B. G. Choi, B. S. Yang, Optimum shape design of rotor shafts using genetic algorithm, *Journal of Vibration and Control* 6 (2000) 207-222.  
 [2] Y. H. Kim, A. Tan, B. S. Yang, W.C. Kim, B. K. Choi, Y. S. An, Optimum shape design of rotating shaft by ESO Method, *Journal of Mechanical Science and Technology* 21 (2007) 1039-1047.  
 [3] M.A. Alfares, A.A. Elsharkawy, Effect of axial preloading of angular contact ball bearings on the dynamic of a grinding machine spindle system, *Journal of Material Processing Technology*, 136 (2003) 48-59.

[4] W. Jacobs, R. Boonen, P. Sas, D. Moens, The influence of the lubricant film on the stiffness and damping characteristics of a deep groove ball bearing, *Mechanical Systems and Signal Processing*, 42 (2014) 335-350.  
 [5] B. S. Yang, S. P. Choi, Y. C. Kim, Vibration reduction optimum design of a steam-turbine rotor-bearing system using a hybrid genetic algorithm, *Struct Multidisc Optim* 30 (2005) 43-53.  
 [6] F. Straub, M. Inagaki, J. Starke, Reduction of vibration level in rotordynamics by design optimization, *Struct Multidisc Optim* 34 (2007) 139-149.  
 [7] M. Aleyaasin, R. Whalley, M. Ebrahimi, Error correction in hydrostatic spindles by optimal bearing tuning, *International Journal of Machine Tools & Manufacture* 40 (2000) 809-822.  
 [8] N. Ozawa, T. Sugano, Y. Yoshida, Measuring method of central position of spindle rotation 2<sup>nd</sup> report, evaluation of new method and experimental results of hydrostatic bearing spindle, *Transaction of The Japan Society of Mechanical Engineers, C* 60 (572) (1994) 1387-1390.  
 [9] D. E. Goldberg, *Genetic algorithm in search, optimization & machine learning*, Addison Wesley, New York (1989).  
 [10] M. Lalanne, B. G. Ferraris, *Rotordynamics prediction in engineering*, Wiley, New York (1998).  
 [11] T. Yamamoto, Y. Ishida, *Linear non-linear rotordynamics a modern treatment with applications*, John Wiley and Son, New York (2001).  
 [12] M. I. Friswell, J. E. T. Penny, S. D. Garvey, A. W. Lees, *dynamic of rotating machine*, Cambridge University Press, New York (2010).