

Evaluation of Dynamic Behavior a Machine Tool Spindle System through Modal and Unbalance Response Analysis

Khairul Jauhari, Achmad Widodo, Ismoyo Haryanto

Abstract—The spindle system is one of the most important components of machine tool. The dynamic properties of the spindle affect the machining productivity and quality of the work pieces. Thus, it is important and necessary to determine its dynamic characteristics of spindles in the design and development in order to avoid forced resonance. The finite element method (FEM) has been adopted in order to obtain the dynamic behavior of spindle system. For this reason, obtaining the Campbell diagrams and determining the critical speeds are very useful to evaluate the spindle system dynamics. The unbalance response of the system to the center of mass unbalance at the cutting tool is also calculated to investigate the dynamic behavior. In this paper, we used an ANSYS Parametric Design Language (APDL) program which based on finite element method has been implemented to make the full dynamic analysis and evaluation of the results. Results show that the calculated critical speeds are far from the operating speed range of the spindle, thus, the spindle would not experience resonance, and the maximum unbalance response at operating speed is still with acceptable limit. ANSYS Parametric Design Language (APDL) can be used by spindle designer as tools in order to increase the product quality, reducing cost, and time consuming in the design and development stages.

Keywords—ANSYS parametric design language (APDL), Campbell diagram, Critical speeds, Unbalance response, The Spindle system.

I. INTRODUCTION

THE most important components in machine tool system is the system of spindle. The dynamic properties of the spindle directly affect the machining productivity and quality of the product. Thus it is important and necessary to determine the dynamic behaviors of spindles in the design and development stages of spindle system in order to avoid resonance due to machining operations. To obtain dynamic analysis of spindle system analytically in the early design stage, the finite element method (FEM) has been frequently adopted in modeling rotor dynamics. Basically, the FEM model for the spindle systems of machine tools is similar to those developed in rotor dynamic. However, the spindle shafts used in machine tools usually have smaller shaft diameters and bearings, and possess disk-like in turbomachine components.

Khairul Jauhari is with the University of Diponegoro, Semarang, Indonesia (phone: +62 815 65 45792; e-mail: khairul.j4uhari@gmail.com).

Khairul Jauhari is with the Agency for The Assessment and Application of Technology, Center for Machine Tools, Production & Automation, Tangerang Selatan, Indonesia (phone: +62 21 702 86019; e-mail: khairul.jauhari@bppt.go.id).

Achmad Widodo and Ismoyo Haryanto are with with the University of Diponegoro, Semarang, Indonesia (e-mail: awidodo2010@gmail.com).

Thus, in this paper we attempt to review some researches relating to the field of rotordynamics.

Lin et al. [1] stated that the most popular approach for modeling the dynamic behavior of a spindle shaft is the finite element method (FEM), because of its capability to manage complex geometry and boundary condition and the calculation approaches save time and money while solving the finite element system equation. Lin [2] developed a genetic algorithm (GA) optimization approach to search the optimal location of bearings on the motorized spindle shaft. The goal is to maximize its first-mode natural frequency (FMNF). In order to achieve the results, dynamic model of the spindle-bearing system is formulated by finite element method (FEM) that was developed in the rotordynamics. Nelson and McVaugh [3], and Nelson [4] employed the Timoshenko beam theory to establish the matrix of systems for analyzing the dynamics of rotor systems including the effects of rotational inertia, gyroscopic moments, shear deformation, and axial load. Zorzi and Nelson [5] presented the influences of damping on the rotating systems dynamics. Cao and Altintas [6] proposed a general method that can be used for the modeling of the spindle-bearing systems. The spindle shaft and housing are modeled as Timoshenko's beam element by including the centrifugal force and gyroscopic effect. The stiffness matrix of the bearing, the contact angle, preload and deflection of spindle shaft and housing are all coupled in the finite element model of the spindle assembly. Erturk et al. [7] proposed an analytical method that uses the inverse of dynamics stiffness matrix coupling and structural modification for modeling spindle-holder-tool assemblies. All components of the spindle-holder-tool assembly are modeled as multi-segment Timoshenko beams and Euler-Bernoulli beam model, and the results are compared with those formulation. They found that Euler-Bernoulli model may yield inaccurate results at high frequencies. Chateled et al. [8] studied the modeling approaches are used in a modal analysis method for calculating the dynamic characteristics (frequencies and mode shapes) of the rotating assemblies of turbo-machines. They compared the results of modeling approaches are obtained from the 3D finite element and 1D finite element. The results show that the behavior of such systems may be inaccurate modeled using one-dimensional beam. Whalley and Abdul-Ameer [9], by using simple harmonic response methods, calculated the critical speed and rotational frequency of shaft-rotor systems where the shaft profiles are contoured. Taplak and Parlak [10] studied the evaluation of gas turbine rotor

dynamic analysis using finite element method. They obtained the critical speeds, Campbell value and the response of the rotor to the center of mass unbalance in the compressor. A program named Dynrot was used to make full dynamic analysis and the evaluation of the results. For this purpose, a gas turbine rotor with certain geometrical and mechanical properties was modeled and its dynamic analysis was made by Dynrot program. Jalali et al. [11] performed the full rotor dynamic analysis of a high speed rotor-bearing system using 3D finite element model generated by ANSYS, one-dimensional model beam type model and experimental modal test. They obtained the Campbell diagram, critical speeds, and unbalance response with the use of both beam model and 3D FE model. The results were compared and good agreement between the theoretical and experimental result indicates the accuracy of the finite element model. Villa et al. [12] have been investigated the behavior of nonlinear flexible unbalanced rotor which supported by roller bearings. In this case, the method of harmonic balance was used to find a periodic response of this non-linear system. In frequency form, stability of the system was identified based on a perturbation applied method. They stated that the method of harmonic balance with the AFT application can be used to obtain harmonic solutions. Bai and colleagues [13] examined the dynamic behaviors of hydroturbine main shaft by using a program named ANSYS. They developed ANSYS Parametric Design Language to generate the geometry model of 3D, analysis of modal, and obtaining critical speed at the spin speed. By using ANSYS Parametric Design Language, critical speed determination and analysis of unbalance response for a multi segment rotor have been presented by [14] and [15]. They showed the advantage of using this method is that by typing one of the input script as example shaft diameter, rotor segment length, loads experienced by the rotor, the command of "ANTYPE,MODAL", and "HARMIC" command, all of these commands can be read as variable input and execution command of the program. These scripts are executed by ANSYS Programming Design Language. Results of these programming languages are validated with results of theoretical and measurement, which are a good agreement of the acceptable limits.

This paper presents an alternative procedure called a full rotor-dynamics analysis for investigating the modal and harmonic analysis of the spindle systems. For this reason, obtaining the Campbell diagrams and determining the critical speeds are very useful to evaluate the spindle system dynamics. The unbalance response of the system to the center of mass unbalance at the cutting tool is also calculated to investigate the dynamic behavior practically and to verify the critical speeds obtained from the modal analysis. In this study, a program named ANSYS Parametric Design Language (APDL) has been implemented to make the dynamic analysis and evaluation of the results. For this purpose, a grinding spindle system with certain geometrical and mechanical properties is modeled and its dynamic analysis was made by ANSYS (APDL). The results show that the calculated critical speeds are far enough from the operating speed range of the

spindle, thus, the spindle would not experience resonance, and the maximum unbalance response is still with acceptable limit.

II. THEORETICAL AND PRACTICAL FORMULATION

In this paper, a Leadwell STD V-30 spindle system of grinding machine tool is shown in Fig. 1. The spindle is designed to operate at up 8,000 rev/min with a 5.6 kW motor connected to the shaft with a pulley-belt system. In this model, cutting tool, tool-holder, spindle shaft, and bearings were included. All components of cutting tool-holder-spindle-bearings assembly are modeled as an assemblage of discrete disk and bearings and the multi-segment beams with distributed mass and elasticity. Since the finite element discretization procedure is well documented in many literatures [16]-[18], the detail of equations will not be derived here and only the general equation of motion is presented below.

A. Equation of the Element Motion

The shaft element is modeled as a Timoshenko beam with a constant circular cross-section. The finite element used has two nodal points and having eight degree of freedom elements which are two translations and two rotations at each nodal point of the element. Each shaft element has a translational mass matrix (M_e^T), a rotational mass matrix (M_e^R), a gyroscopic matrix (G_e), a stiffness matrix (K_e), and a force vector (F_e). The equation of motion in a fixed frame, for one shaft element rotating with a constant speed Ω can be expressed as

$$\left(M_e^T + M_e^R \right) \ddot{q}_e - \Omega G_e \dot{q}_e + K_e q_e = F_e \quad (1)$$

where q_e is the nodal displacement vector, containing the eight degrees-of-freedom of the shaft element (two translations and two rotations in each node). By combining the individual matrices of each shaft element, one can obtain the global matrices that represent the whole shaft, thus resulting to the following equation of motion:

$$\left(M_G^T + M_G^R \right) \ddot{q} - \Omega G_G \dot{q} + K_G q = F_G \quad (2)$$

where (M^T) is the global translational mass matrix, (M^R) is the global rotational mass matrix, (G) is the global gyroscopic matrix, (K) is the global stiffness matrix, (F) is the global force vector acting on the shaft element, and (q) is the displacement vector containing all $4(n_e + 1)$ degrees-of-freedom of the shaft elements that represent the physical shaft (n_e is the number of shaft elements).

Mass elements are modeled as rigid disk. The rigid disk is required to be located at a finite element nodal point. For the rotating speed Ω is assumed to be constant then here q_d is the nodal displacement vector of the disk center. The equation can be expressed as

$$\left(M_d^T + M_d^R \right) \ddot{q}_d - \Omega G_d \dot{q}_d = F_d \quad (3)$$

where (M_d^T) is the disk element translational mass matrix, (M_d^R) is the disk element rotational mass matrix, (G) is the disk element gyroscopic matrix.

The dynamic characteristics of the bearings can be represented by stiffness and damping coefficients. The forces acting on the shaft can be expressed as

$$C_{br} \dot{q}_{br} + K_{br} q_{br} = F_{br} \quad (4)$$

where (C_b) and (K_b) are the bearing damping and stiffness matrices, and (F_b) is the bearing force acting on the shaft.

B. Equation of Global System and Analysis of Eigenvalue

Based on the motion equations of elements in (2), (3), and (4) then a certain global element equation can be established and other global equations also can be generated for the other elements. These elements are constructed to form the general equation, which represents the behavior of the whole system. Then here, the motion equation of the damped system for global coordinates which can expressed as

$$M_G \ddot{q} + C_G \dot{q} + K_G q = F_G \quad (5)$$

Here,

$$C_G = C_{br} - \Omega G_e - \Omega G_d, K_G = K_e + K_{br}, F_G = F_g + F_u + F_a + F_h$$

In order to obtain the natural frequency of system, then eigenvalue must be solved and expressed by (5); the system equation can be set as a state variable vector.

$$A_s \dot{x} + B_s x = 0 \quad (6)$$

where the matrices of A_s , B_s , and displacement x consist of element matrices given as

$$A_s = \begin{bmatrix} M_G & C_G \\ 0 & I \end{bmatrix}, \quad B_s = \begin{bmatrix} 0 & K_G \\ -I & 0 \end{bmatrix}, \quad x = \begin{bmatrix} \dot{q} \\ q \end{bmatrix}$$

For assuming harmonic solution $x = x_0 e^{\lambda t}$ of (6), the solution of an eigenvalue problem is

$$(A_s \lambda + B_s) x_0 = 0 \quad (7)$$

To obtain the matrix solution of (7) then the determinant of this matrix equation must be equal to zero

$$|\lambda I + C_a| = 0 \quad (8)$$

where, $C_a = A_s^{-1} B_s$ and λ is an eigenvalue. The eigenvalues are usually as the complex number and conjugate roots.

$$\lambda_k = \alpha_k \pm i\omega_k \quad (9)$$

Here, α_k and ω_k are the stability factor of growth and the k^{th}

mode of damped frequencies, respectively.

C. Response of Unbalance

The forces of mass unbalance (F_u) which is shown in (5) can be expressed as

$$F_u = F_{u \max} \Omega^2 e^{i\Omega t} \quad (10)$$

The response of unbalance mass is considered to be as the form

$$P = P_u e^{i\Omega t} \quad (11)$$

Substituting (10) and (11) into (5), the equation can be expressed as

$$(K - \Omega^2 M + i\Omega C) p_u = F_u \Omega^2 \quad (12)$$

By solving (12), the response of steady state can be obtained.

D. ANSYS Parametric Design Language (APDL)

In this paper, a practical APDL macro scripting language has been developed to generate all the required results, containing amplitude plots and frequency plots at all the nodes of the model, with minimal effort of the user. The algorithm incorporated in the macro is as

- 1) Setup the model. Impose the boundary conditions and apply excitation force.
- 2) Performing the analysis of modal for obtaining the natural frequencies and the critical speeds. Set solution using "ANTYPE, MODAL" command. Retrieve mode frequency and critical speed frequency using "*GET" command and store in using "*VFILL" command.
- 3) Perform harmonic analysis for obtaining unbalance response and provides validation for the frequency found by modal analysis through harmonic analysis. Set solution using "HARMIC" command and set the range of excitation frequencies to increment from 0 to maximum operating speed in a number of steps (using "NSUBST" command).
- 4) Solve for unbalance response. Plot results to get an unbalance response at nodal point 'n'.
- 5) Increment parameter 'n' by 1. If $n > 18$ (since the spindle-bearing system model here contains 18 nodal points), if ok then go to the next step. Otherwise, go back to step 3.
- 6) End of program.

III. THE MODEL OF FINITE ELEMENT

Table I describes the mechanical and geometrical properties of shaft element. In this study, the spindle shaft is modeled into 17 elements of beam and points of node at the end of each element. Two-masses of the cutting tool and the pulley-belt components can be considered as 1 and 3 elements of rigid disk, respectively. These elements of rigid disk are located at the nodal point of number 1, 14, 15 and 16. The parameters of the mass element are tabulated in Table II. In addition the two

sets of bearings, located at the nodal points 5 and 12. These bearings are modeled as symmetric isotropic bearings and stiff elastic constraints. Table III shows a model of bearing elements. A schematic of the spindle's finite element model is shown in Fig. 2.

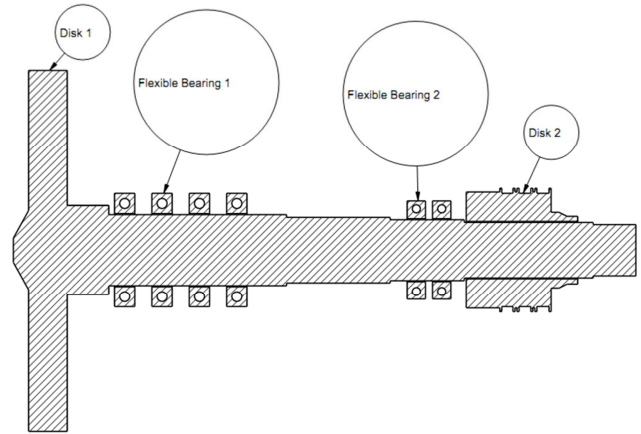

Fig. 1 Cross section geometry of spindle system

TABLE I
 MECHANICAL PROPERTIES AND GEOMETRICAL OF THE SHAFT ELEMENT

Element numbers	1	2	3	4	5	6	7	8	9
Diameter D_o (mm)	88	88	70	70	70	70	64.5	64.5	64.5
Length L (mm)	20.5	20.5	43.75	43.75	43.75	43.75	34	34	34
ρ (kg/m ³)	7800	7800	7800	7800	7800	7800	7800	7800	7800
E (GPa)	210	210	210	210	210	210	210	210	210
Element numbers	10	11	12	13	14	15	16	17	18
Diameter D_o (mm)	60	60	60	60	54.5	54.5	50.4	50.4	-
Length L (mm)	18.25	18.25	18.25	18.25	63.5	63.5	21	21	-
ρ (kg/m ³)	7800	7800	7800	7800	7800	7800	7800	7800	-
E (GPa)	210	210	210	210	210	210	210	210	-

TABLE II
 MODEL PROPERTIES OF DISK ELEMENT

Mass numbers	1	2	3	4
Nodal numbers	1	14	15	16
m (kg)	15.866	2.415	2.415	2.415
J_p (kg.m ²)	0.486	0.005	0.005	0.005
J_t (kg.m ²)	0.247	0.003	0.003	0.003

TABLE III
 MODEL PROPERTIES OF THE BEARING ELEMENT

Bearing number	1	2
Nodal number	5	12
K_{yy} (N/m)	1.911×10^8	2.476×10^8
C_{yy} (N.m/s)	191.10×10^2	247.60×10^2
K_z (kg.m ²)	1.911×10^8	2.476×10^8
C_z (N.m/s)	191.10×10^2	247.60×10^2

As can be described in Fig. 3, a three-dimensional geometry model of the spindle-bearing system is established with the APDL (ANSYS Parametric Design Language) program. The spindle shaft is considered as the elements of BEAM188 with an internal node and the function of quadratic shape to increase the element accuracy. The characteristic of BEAM188 has two nodal points and having twelve degrees of freedom at each element; the motions are translated in the x , y and z axis direction and rotation about x , y and z axis. The element of MASS21 is used for modeling of disk element (mass of rigid disk) and element of COMBIN14 is used for modeling the symmetry bearings. The nodal points, elements, material properties, real constants, boundary conditions and other physical system-defining features that constitute the model have been created by using APDL commands such as *RO*, *PEX*, *PGXY*, *MP*, *ET*, *MAT*, *K*, *N*, *LSTR*, *R*, *RMORE*, *LATT*, *LESIZE* and *E*.

Shear effect cannot be ignored in the spindle shaft. The constraints are applied to the element motions of displacement in the x axis direction and rotation about the x axis, thus the spindle shaft would not experience any displacements of translation and twist motion about the x axis direction. Parameters for the material and element properties of this spindle shaft model are the same as in the beam finite element model.

A modal analysis is performed on a spindle-bearing system with QRDAMP method to determine the whirl speeds and Campbell value, the CORIOLIS command is activated in a

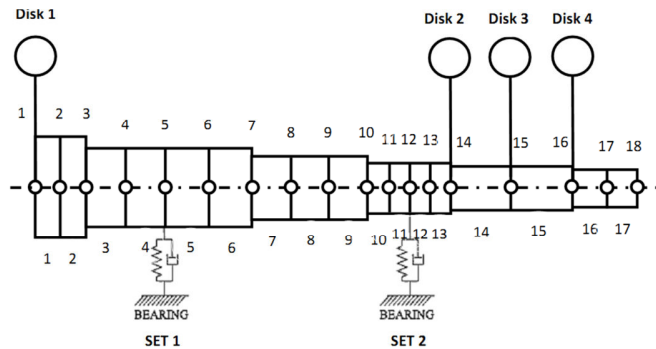

Fig. 2 Discretization model of the STD V-30 grinding spindle

stationary reference frame to apply “Coriolis Effect” to the rotating structure. The whirl speeds for slope (excitation per revolution) 1x is determined. Harmonic analysis also performed with SYNCHRO command to determine amplitude response values.

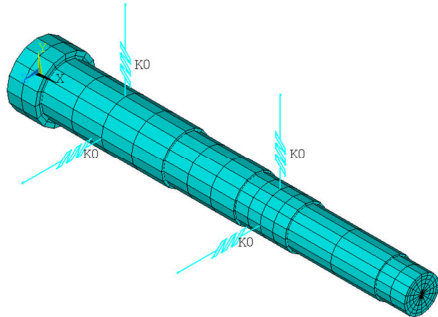

Fig. 3 3D view finite element of spindle shaft generated by APDL program

IV. RESULTS

In this paper, in order to investigate the dynamic behavior of the spindle at operating speeds, the Campbell diagrams, critical speeds, and unbalance response are obtained. The numerical analyzes are performed considering speeds ranging from 0 to 27000 rpm. Table IV shows the damped natural frequencies of the spindle assembly (at operating speed 8000 rpm) obtained by the APDL FE model. Fig. 6 shows the Campbell diagrams obtained by the finite element (FE) model constructed in APDL program. Also, the operating deflection shapes at two speeds are obtained in Figs. 4 and 5.

TABLE IV
 NATURAL FREQUENCIES AT OPERATING SPEED (AT 8000RPM)

No	Nat. Frequencies	APDL Model (Hz)
1	Mode 1 (1 st backward whirling)	137.518
2	Mode 2 (1 st forward whirling)	186.467
3	Mode 3 (2 nd backward whirling)	321.266
4	Mode 4 (2 nd forward whirling)	338.133
5	Mode 5 (3 rd backward whirling)	514.517
6	Mode 6 (3 rd forward whirling)	683.315

186.467 Hz
 FW (Forward Whirl)

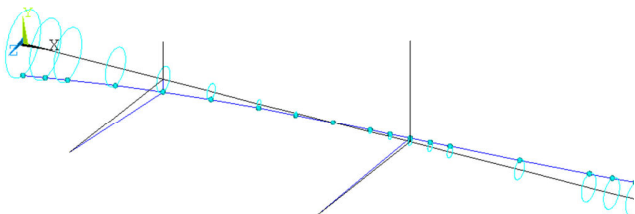

Fig. 4 Deflection shape corresponding to 1stFW mode

338.133 Hz
 FW (Forward Whirl)

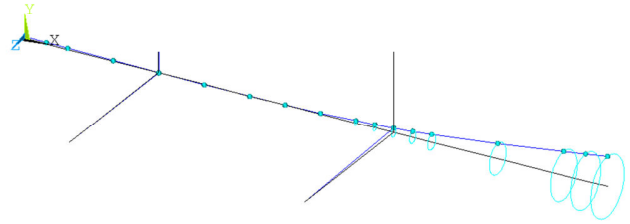

Fig. 5 Deflection shape corresponding to 2nd FW mode

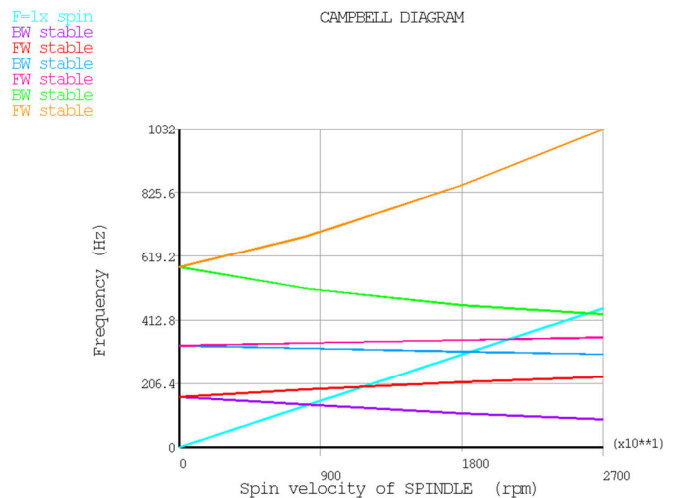

Fig. 6 Campbell diagram from APDL model

As can be seen from Table V, the speeds which are the coincidence of the spindle rotating speed and the rotating natural frequencies of the spindle are obtained from the APDL finite element models. There are three backward whirls (BW) and two forward whirls (FW) modes were considered. They are 1st backward whirl, 1st forward whirl, 2nd backward whirl, 2nd forward whirl, and 3rd backward whirl, respectively critical speeds. We also obtained the deflection of mode shapes relating to these five critical speeds. The shape of deflection at critical speed relating to 1st backward whirl, 1st forward whirl, 2nd backward whirl, 2nd forward whirl, and 3rd backward whirl are shown in Figs. 7-11.

TABLE V
 CRITICAL SPEEDS AT SPEED RANGE

No	Critical Speed	APDL Model (Rpm)
1	1 st backward whirl	8215.225
2	1 st forward whirl	11751.541
3	2 nd backward whirl	18610.909
4	2 nd forward whirl	21017.776
5	3 rd backward whirl	26033.467

8215.225 rpm
 BW (Backward Whirl)

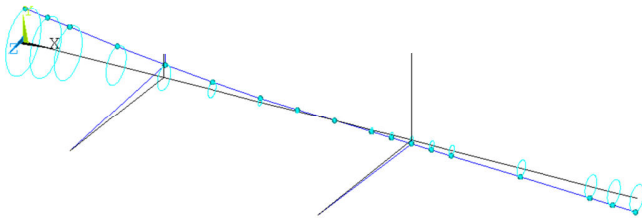

Fig. 7 Deflection shape relating to 1st BW

26033.467 rpm
 BW (Backward Whirl)

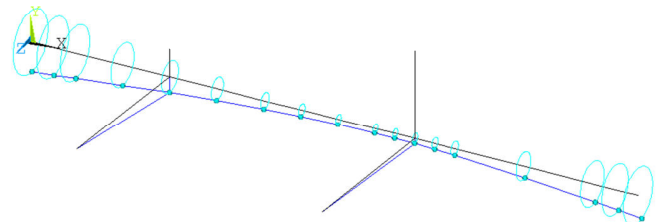

Fig. 11 Deflection shape relating to 3rd BW

11751.541 rpm
 FW (Forward Whirl)

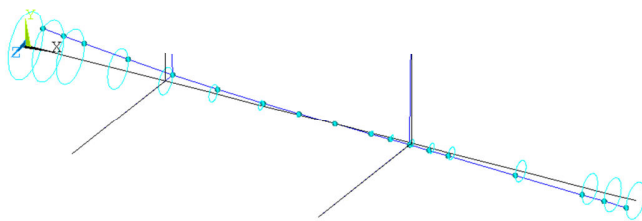

Fig. 8 Deflection shape relating to 1st FW

18610.909 rpm
 BW (Backward Whirl)

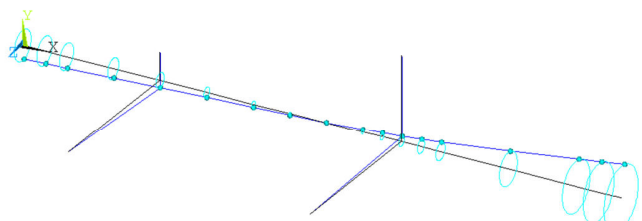

Fig. 9 Deflection shape relating to 2nd BW

21017.776 rpm
 FW (Forward Whirl)

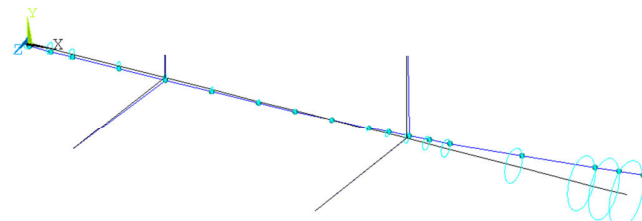

Fig. 10 Deflection shape relating to 2nd FW

Unbalance response analysis is carried out to investigate the dynamic behaviors of spindle systems which provide validation for the frequency found by modal analysis through harmonic analysis. An unbalance of 9.981×10^{-5} kg m at the center gravity of the cutting tool is considered in the APDL model. The nodal solutions of unbalance responses have been obtained using the APDL FE model which is tabulated in Table VI.

TABLE VI
 NODAL SOLUTION OF UNBALANCE RESPONSE

Node	APDL MODEL (Hz)	Maximum Amplitude (m)
Node 1 (Disk 1)	197	0.364×10^{-4}
Node 5 (Bearing set 1)	197	0.146×10^{-4}
Node 1 (Disk 1)	351	5.510×10^{-6}
Node 12 (Bearing set 2)	351	4.370×10^{-6}

As can be seen from the table, the maximum amplitudes occur near at the 1st forward whirling and 2nd forward whirling critical speeds points which were calculated in the Table V. It's mean that if the system has damping, the system will resonant when it approaches at these critical points. It is looked at the Table VII, the maximum amplitudes are not coincide 195.8 Hz and 350.3 Hz which were calculated previously in modal analysis. The percentage difference between both model analyses are in very good agreement and the maximum difference is about 0.61 %.

TABLE VII
 NODAL SOLUTION OF UNBALANCE RESPONSE

Critical Speed	Modal Analysis (Hz)	Harmonic Analysis (Hz)
1 st forward whirling	195.8	197
2 nd forward whirling	350.3	351

Based on this unbalance response analysis, it is easy to understand that the critical speed of the spindle is the speed corresponding to the intersection of the natural frequency (Hz) equal to spindle spin's (rpm) line with only the forward whirl mode. Fig. 12 shows the unbalance response of the spindle-bearing system that was evaluated at nodal points 1, 5, and 12, which stated disk 1 (cutting tool), bearing set 1, and bearing set 2, respectively. Figs. 13 and 14 show the mode shapes at two first critical speeds.

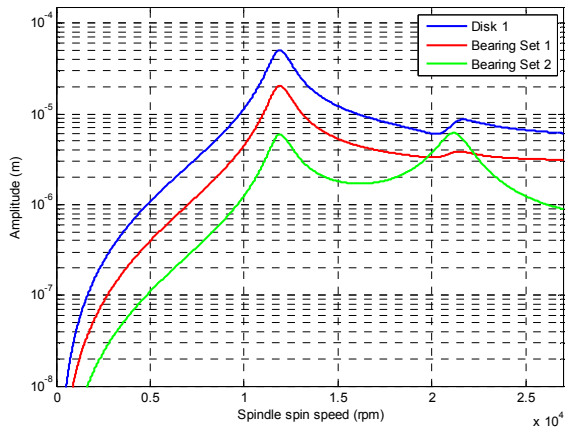

Fig. 12 Unbalance response of spindle system (APDL model)

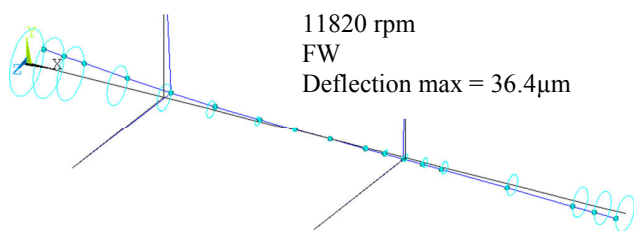

Fig. 13 The behavior of the system at the 1st forward critical speed

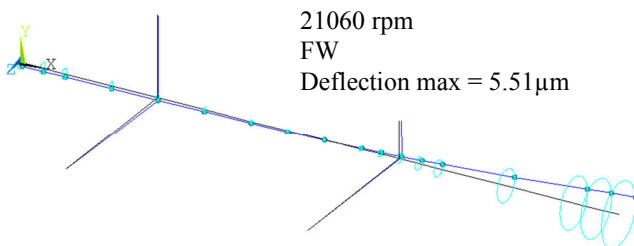

Fig. 14 The behavior of the system at the 2nd forward critical speed

V. CONCLUSION

A program named ANSYS Parametric Design Language (APDL) based on finite element method has been implemented to make the full dynamic analysis and evaluation of the results. A grinding spindle system with certain geometrical and mechanical properties is modeled as beam APDL model technique. The deflection shapes of the spindle at operating speeds, the Campbell diagrams, critical speeds, and unbalance response are obtained. Based on this unbalance response analysis that the critical speeds of the spindle are the 1st forward whirling and 2nd forward whirling, which the speed corresponding to the intersection of the natural frequency (Hz) equal to spindle spin's (rpm) line with only the forward whirl mode. These critical speeds are still far from the operating speed range of the spindle, thus, the spindle would not experience resonance, and the maximum unbalance response at operating speed is still with acceptable limit. Thus, APDL program can be used by spindle designer as tools in order to increase the product quality, reducing cost, and time consuming in the design and development stages.

REFERENCES

- [1] C.W. Lin, Y.K. Lin, C.H. Chu, Dynamic models and design of spindle-bearing system of machine tools: a review, *International Journal of Precision Engineering and Manufacturing* 14 (2013) 513-521.
- [2] C.W. Lin, Optimization of bearing locations for maximizing first mode natural frequency of motorized spindle-bearing systems using a genetic algorithm, *Applied Mathematics* 5 (2014) 2137-2152.
- [3] H.D. Nelson, J.M. McVaugh, The Dynamics models of rotor-bearing systems using finite elements, *Journal of Engineering for Industry, Transactions of the ASME* 93 (1976) 593-600.
- [4] H.D. Nelson, A finite rotating shaft element using Timoshenko beam theory, *Journal of Mechanical Design, Transactions of the ASME* 102 (1980) 793-803.
- [5] E. Zorzi, H.D. Nelson, Finite element simulation of rotor-bearing systems with internal damping, *Journal of Engineering for Power, Transactions of the ASME* 7 (1977) 71-76.
- [6] Y. Cao, Y. Altintas, A general method for the modeling of spindle-bearing system, *Journal of Mechanical Design* 120 (2004) 1089-1104.
- [7] A. Erturk, H.N. Ozguven, E. Budak, Analytical modeling of spindle-tool dynamics on machine tools using Timoshenko beam model and receptance coupling for the prediction of tool point FRF, *International Journal of Precision Machine Tools & Manufacture* 46 (2006) 1901-1912.
- [8] E. Chatelet, F. D'Ambrosio, G. Jacquet-Richardet, Toward global modeling approaches for dynamic analyses of rotating assemblies of turbomachines, *Journal of Sound and Vibration* 282 (2005) 163-178.
- [9] R. Whalley, A. Abdul-Ameer, Contoured shaft and rotor dynamics, *Mechanism and Machine Theory* 44 (2009) 772-783.
- [10] H. Taplak, M. Parlak, Evaluation of gas turbine rotor dynamic analysis using the finite element method, *Measurement* 45 (2012) 1089-1097.
- [11] M.H. Jalali, M. Ghayour, S. Ziaei-Rad, B. Shahriari, Dynamic analysis of high speed rotor-bearing system, *Measurement* 53 (2014) 1-9.
- [12] C. Villa, J.J. Sinou, F. Thouverez, Stability and vibration analysis of a complex flexible rotor bearing system, *Communications in Nonlinear Science and Numerical Simulation* 13 (2008) 804-821.
- [13] B. Bai, L. Zhang, T. Guo, C. Liu, Analysis of dynamic characteristics of the main shaft system in a Hydro-turbine based on ANSYS, *Procedia Engineering* 31 (2012) 654 - 658.
- [14] B. Gurudatt, S. Seetharamu, P. S. Sampathkumaran, V. Krishna, Implementation of ANSYS Parametric Design Language for the determination of critical speeds of a fluid film bearing supported multi-sectioned rotor with residual unbalance through modal and out-of-balance response analysis, *Proceedings of world congress of Engineering* 2 (2010) 1592-1596.
- [15] K. Jagannath, Evaluation of critical speed of Generator Rotor with external load, *International Journal of Engineering Research and Development* 1 (11) (2012) 11-16.
- [16] M. Lalanne, B.G. Ferraris, *Rotordynamics prediction in engineering*, Wiley, New York 1998.
- [17] M.I. Friswell, J.E.T. Penny, S.D. Garvey, A.W. Lees, *Dynamics of rotating machines*, Cambridge University Press, 2010.
- [18] T. Yamamoto, Y. Ishida, *Linear non linear rotordynamics a modern treatment with applications*, John wiley and sons, USA 2001.