

Effects of Cerium Oxide Nanoparticle Addition in Diesel and Diesel-Biodiesel Blends on the Performance Characteristics of a CI Engine

Abbas Alli Taghipoor Bafghi, Hosein Bakhoda, Fateme Khodaei Chegeni

Abstract—An experimental investigation is carried out to establish the performance characteristics of a compression ignition engine while using cerium oxide nanoparticles as additive in neat diesel and diesel-biodiesel blends. In the first phase of the experiments, stability of neat diesel and diesel-biodiesel fuel blends with the addition of cerium oxide nanoparticles is analyzed. After series of experiments, it is found that the blends subjected to high speed blending followed by ultrasonic bath stabilization improves the stability. In the second phase, performance characteristics are studied using the stable fuel blends in a single cylinder four stroke engine coupled with an electrical dynamometer and a data acquisition system. The cerium oxide acts as an oxygen donating catalyst and provides oxygen for combustion. The activation energy of cerium oxide acts to burn off carbon deposits within the engine cylinder at the wall temperature and prevents the deposition of non-polar compounds on the cylinder wall results reduction in HC emissions. The tests revealed that cerium oxide nanoparticles can be used as additive in diesel and diesel-biodiesel blends to improve complete combustion of the fuel significantly.

Keywords—Diesel engine, cerium oxide, diesel-biodiesel blends, nanoparticles.

I. INTRODUCTION

THE compression ignition engines are widely used due to its reliable operation and economy. As the petroleum reserves are depleting at a faster rate due to the growth of population and the subsequent energy utilization, an urgent need for search for a renewable alternative fuel arise. Also the threat of global warming and the stringent government regulation made the engine manufacturers and the consumers to follow the emission norms to save the environment from pollution. Among the many alternative fuels, biodiesel (vegetable methyl esters) is considered as a most desirable fuel extender and fuel additive due to its high oxygen content and renewable in nature [1], [2]. Biodiesel is a renewable and eco-friendly alternative diesel fuel for diesel engine. Biodiesel has higher viscosity, density, pour point, flash point and cetane number than diesel fuel. Biodiesel is an oxygenated fuel which contains 10–15% oxygen by weight percent. Also it can be

said a Sulfur free fuel. These facts lead biodiesel to total combustion and less exhaust emissions than diesel fuel. Furthermore also the energy content or net calorific value of biodiesel is about 12% less than that of diesel fuel on a mass basis. Using optimized blend of biodiesel and diesel can help reduce some significant percentage of the world's dependence on fossil fuels without modification of CI Engine, and it also has important environmental benefits. For example using optimized blend of biodiesel and diesel instead of the conventional diesel fuel significantly reduces the exhaust emissions particulate matter (PM), carbon monoxide (CO), sulfur oxides (SO_x), and unburned hydrocarbons (HC). Moreover additives are an essential part of today's fuels. Together with carefully formulated base fuel composition, they contribute to efficiency reliability and long life of an engine. They can have surprisingly large effects even when used in parts per million (PPM) range. With use of fuel additives in the blend of biodiesel and diesel fuelled in CI Engine which furthers more improve performance, combustion, and diminish emission characteristics and also improved fuel properties which enhance the combustion characteristics.

Among the various techniques available to reduce exhaust emissions, the use of fuel-borne catalyst is currently focused due to the advantage of increase in fuel efficiency while reducing harmful greenhouse gas emissions and the health-threatening chemicals such as NO_x and particulate matter. The influence of cerium oxide additive on ultrafine diesel particle emissions and kinetics of oxidation was studied by Jung et al. [3]. They found that addition of cerium to diesel cause significant reduction in number weighted size distributions and light-off temperature and the oxidation rate was increased significantly. Escribano et al. [4] studied the structural and morphological characterization of a Ce-Zr mixed oxide supported Mn oxide as well as on its catalytic activity in the oxidation of particulate matter arising from Diesel engines. Mn-Ce-Zr catalyst shows high activity in the soot oxidation producing CO₂ and CO as a by-product in the range 425-725 K. Idriss studied the complexity of the ethanol reactions on the surfaces of noble metals/cerium oxide catalysts [5]. The hazard and risk assessment with the use of nanoparticle cerium oxide bases diesel fuel was studied by [6]. Auffan et al. [7] studied the potential in vitro cyto- and genotoxicity of nano-sized CeO₂ on human dermal fibroblasts. Ali Keskin et al. [8] investigated the influences of Mg and Mo based fuel additives on diesel engine performance running with tall oil biodiesel. A

Abbas Alli Taghipoor Bafghi and Fateme Khodaei Chegeni are with the Department of Mechanical Engineering, Dezful Branch, Islamic Azad University, Dezful, Iran (e-mail: taghipoor460@yahoo.com, Khodaei333@gmail.com).

Hosein Bakhoda is with the Department of Agricultural Machinery Engineering, Faculty of Agriculture and Natural Resources, Tehran Science and Research Branch, Islamic Azad University, Tehran, Iran (e-mail: hossein.bakhoda@gmail.com).

single cylinder DI diesel engine was used in the tests. The authors found that the engine performance values did not change significantly with biodiesel fuels. In the present work, castor oil methyl ester as additive is used with the diesel fuel and the emission reduction potential are investigated using cerium oxide nanoparticles as fuel borne additive with neat diesel and diesel-biodiesel blends on the compression ignition engine.

II. EXPERIMENTAL STUDY

The experimental investigations were carried out in two phases. In the first phase, the various physicochemical properties of diesel – biodiesel blends were determined. The properties studied were the flash point, cloud and pour points and viscosity. Standard ASTM test procedures were used in the experiments. In the second phase, performance tests were conducted on a single cylinder compression ignition engine using the modified and base fuels. The method of preparation of the fuels with the additive nanoparticles along with the experimental methods for obtaining the fuel properties and the details of the performance test facility are all presented below.

A. Preparation of Modified Fuels

Biodiesel used in this investigation was supplied from National Bioenergy Research Center (NBERC) of Tarbiat Modares University, Tehran, Iran. The biodiesel was produced by transesterification method from fried oil. The biodiesel would meet the requirements of international standard of ASTM D6751-09. Table I gives the different diesel-biodiesel fuel blends used in this study. Six fuel mixture samples with different percentages of two types of fuel was prepared and indicated by the acronym BxDy-z where B denotes biodiesel, x is biodiesel percentage in the sample, D is pure diesel, y is the percentage of pure diesel and z is nanoparticle (ppm) in the fuel blend. Some of the major properties of biodiesel are shown in Table II.

TABLE I
 DIESEL AND BIODIESEL FUEL BLENDS USED IN THIS STUDY

B0D100	B5D95	B20D80
--------	-------	--------

The fuel additive used in this investigation is cerium oxide, in the form of commercially available nanoparticles of size 10 to 30 nanometers and density of 7.13 g/mL. The dosing level of the cerium oxide nanoparticle samples (by weight) in the base fuel was varied from 5 to 25 ppm. The required quantity of the nanoparticle sample required for each dosing level was measured using a precision electronic balance and mixed with the fuel by means of an ultrasonic shaker, applying a constant agitation time of 30 minutes to produce a uniform suspension. The modified fuel was utilized immediately after preparation, in order to avoid any settling or for sedimentation to occur.

B. Determination of Fuel Properties

The viscosity, flash, pour and cloud points were measured using standard test methods. The viscosity was measured using the Pethrotest viscometer [9]. One of the main characteristics of the fuel used in cold weather conditions is

could point. This point is a temperature, which the first wax network is created in the cooling liquid to cloud. It is the lowest temperature that the fuel can be used. Using fuel in temperature lower than cloud point can cause fuel filter clogging. The cloud point is determined according to ASTM D5773 standard by observing the fuel transparency that is cold under the controlled conditions [10]. The pour point is the lowest temperature, which the fuel can flow. Then the fuel becomes solid after this temperature and it's not useable. This point is very important to transfer the fuels in cold temperatures. ASTM D97 is the standard to determine the point. A Cleveland open cup flash and fire point apparatus [11] was used for measuring the flash point.

TABLE II
 PROPERTIES OF BIODIESEL AND DIESEL

Diesel Fuel	Biodiesel	unit	Specifications
C16H34	C20H39O2	----	Chemical formula
57.5	62.1	----	Cetane number
42.57	41.3	J/kg	Heat value
3.09	6.482	cSt	Kinematic viscosity at 40°C
0.839	0.878	gr/cm ³	Density at 25°C
----	10.5	%w	amount of oxygen

C. Description of the Test Engine

The experiments were carried out in thermodynamic laboratory, technical faculty, Islamic Azad University, Dezfoul Branch, Dezfoul, Iran. In order to study the effect of different diesel and biodiesel fuel blends on small diesel engine performance parameters a test set up unit (Gunt model CT 159, Germany) was used in this study (Fig. 1). The set up stand consists of three main components including a CT 159 for mounting of the engine and as a control unit, a universal drive and brake unit or dynamometer, (HM 365) as a load unit, and a four-stroke diesel engine (CT 151). The main function of CT 159 is to mount the engine, supply it with fuel and air and record and display relevant measurement data. The engine is mounted on a vibration-insulated base plate and connected by way of a belt drive to HM 365 dynamometer. After the engine warmed up the dynamometer acts as a brake for applying resistant load to the engine. The lower section of the mobile frame contains fuel tanks and a vessel for the intake air. A measuring tube for fuel consumption is also included in the test unit. The speed and torque are adjusted and displayed on the dynamometer. The measured values are transmitted directly to a personal computer via USB and the data acquisition software. The diesel engine brake power, torque and brake specific fuel consumption was measured at four engine speed levels (1500, 2000, 2400 and 2600 rpm) for the diesel-biodiesel fuel blends. The specifications of the direct injection diesel engine to carry out the tests are given in Table II.

A four stroke, single cylinder, air-cooled compression ignition engine was used to conduct the performance and emission studies. Engine is coupled to an eddy current dynamometer. A computerized data acquisition system is used to collect and store the data during the engine testing. Specifications of the engine used for the performance study

are given in Table III, and a schematic block diagram of the experimental test facility is illustrated in Fig. 1.

TABLE III
 ENGINE SPECIFICATIONS

Hatz 1B20-6	Model
Gunt	Company
1	Number of Cylinder
mm 62	Stroke
69mm	Bore
approx. 1.5 kW	Rated output
21: 1	Compression ratio
Air cooled	Cooling System
DI	Type of fuel system
l×w×h 485 × 355 × 520 mm	Dimension
0.9 Lit	Oil Volume

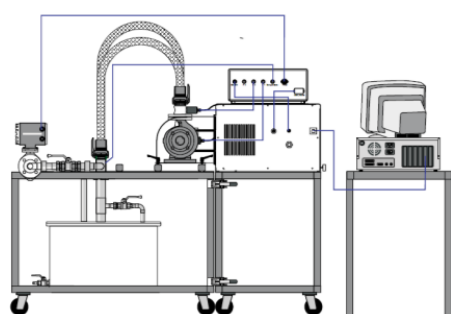

Fig. 1 Schematic of the experimental set up

III. RESULTS AND DISCUSSION

The ASTM standard tests to determine various physicochemical properties of the base fuels (Bio diesel) as well as the modified fuels were carried out under identical laboratory condition so that the results could be compared. The primary objectives of this investigation were to determine the variations in the properties of the fuels, due to the addition of the cerium oxide nanoparticles and to estimate the effect of the level of inclusion of the additives (dosing level) on these variations. Performance tests were conducted on the diesel engine using the modified fuel samples and compared with those with the base fuels, to determine the engine performance enhancement and the reduction of emissions, due to the addition of the catalyst. Based on the experimental results, the variations in the physicochemical properties of the fuel, and the variations in the efficiency and emissions of the CI engine using the modified fuels were determined with various dosing levels as given below. Some indications on the existence of optimum additive nanoparticle dosing levels were also obtained as discussed in this section.

A. Fuel Properties

The flash point of the fuel gives an indication of the volatility of a fuel. The lower the volatility, the higher the flash and fire points are. Fig. 2 shows the variation of the flash point of the diesel-biodiesel blends as a function of the dosing level. As illustrated, the bio diesel shows an increasing trend for the flash point with the dosing level, which indicates a successive decrease in the volatility of the fuel with increases

in the quantity of the fuel additive. As illustrated in Fig. 2, this increase is nearly linear. Higher flash point temperatures are desirable for safe handling of the fuel. In this context, and because of its higher flash point temperature, the fuels modified with cerium oxide nanoparticles are inherently safer than the base fuels.

The influence of the dosing level of the additive on the kinematic viscosity of diesel-biodiesel blends are illustrated in Fig. 3, which indicates that the viscosity of the fuels decrease with an increase for all dosing levels. The change in the viscosity of the fuel affects the engine performance as well as the hydrocarbon emissions. Lower fuel viscosities may not provide sufficient lubrication of fuel injection pumps or injector plungers resulting in leakage or increased wear thus reducing the maximum fuel delivery. This imposes a limitation on the quantity of the fuel additive that can be used in enhancing the combustion performance of the fuel. The fuel atomization is affected by the fuel viscosity, and the fuel with higher viscosity tends to form larger droplets on injection, which can cause poor combustion and increased exhaust smoke and emissions. Thus, the selection of the dosing level of the catalyst should be based on a compromise between these two mutually contradicting effects on the performance of the engine.

Figs. 4 and 5 show the variation of the pour and cloud points of the diesel-biodiesel blends as a function of the dosing level. As illustrated, the fuels show a decreasing trend for the cloud and pour points with the dosing levels.

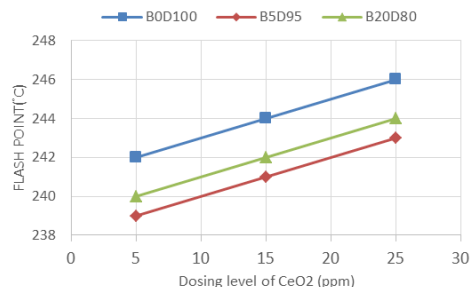

Fig. 2 Variation of flash point with nanoparticle dosing level for diesel- biodiesel blends

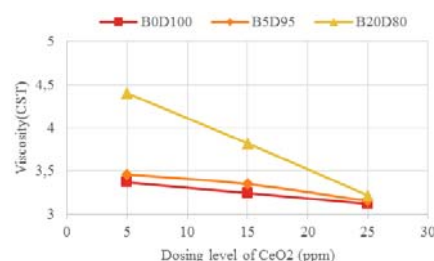

Fig. 3 Variation of viscosity with nanoparticle dosing level for diesel-biodiesel blends

A. Engine Power

Using the data of power, torque, fuel consumption and specific fuel consumption tests, Figs. 6-9 were drawn by Excel software. In Fig. 6, changes of engine power under experiment

relative to engine revolution rate have been shown using mixtures of diesel-biodiesel fuels and nanoparticles.

Diagrams related to power changes relative to engine revolution rate shows that all fuel mixtures have the maximum power at 2400 rpm. Among these mixtures, B5D95-25 has greater maximum power and B0D100 has the lowest maximum power. In the general state, the power of mixtures increases gradually up to 2400-rpm speed. In addition, in 2400 to 2600 rpm, the power of mixtures decreases or in some compounds increases slightly. In almost all speeds, power resulted from pure diesel fuel is less than the power of biodiesel-diesel compounds and nanoparticles, though in some references it has been stated that engine power in biodiesel fuel compounds should be less than pure diesel fuel due to the lower heating value of biodiesel fuel [12]. Therefore, it seems that since biodiesel fuel and nanoparticles have oxygen, full combustion of the power resulted from diesel-biodiesel fuel compounds and nanoparticles increases.

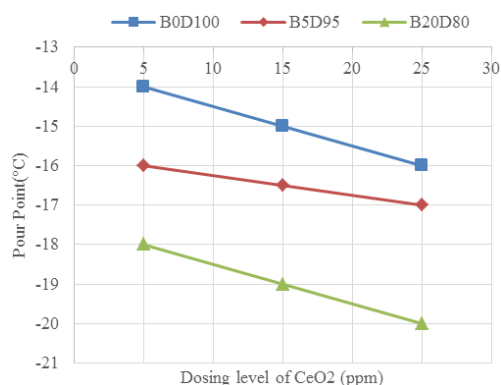

Fig. 4 Variation of pour point with nanoparticle dosing level for diesel- biodiesel blends

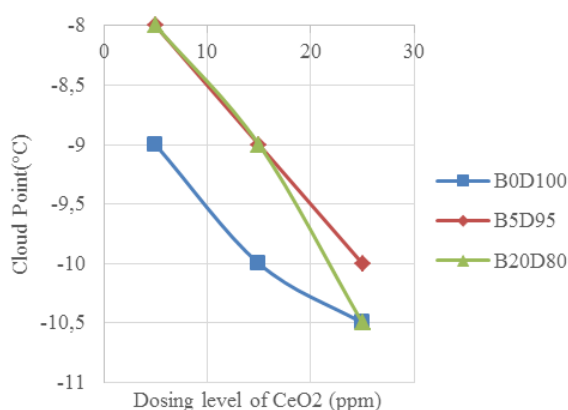

Fig. 5 Variation of cloud point with nanoparticle dosing level for diesel- biodiesel blends

B. Engine Torque

Changes of engine torque under experiment relative to engine revolution rate using biodiesel-diesel fuel mixtures and nanoparticles are shown in Fig. 7. As can be seen in Fig. 7, by increasing engine speed, torque decreases gradually in all fuels. In these speed ranges, B5D95-25 mixture has the highest value and B0D100 fuel has the lowest value. By more

increasing the speed, torque decreases and then remains constant in almost all mixtures. Generally, the cause of engine torque changes is well filling of the cylinder in the breathing stage. In very high speeds, breathing time is lesser and consequently the cylinder is not filled fully. As a result, compaction pressure and combustion pressure become lesser, inertial forces of mobile parts of the engine increase, and finally the real torque of the engine decreases.

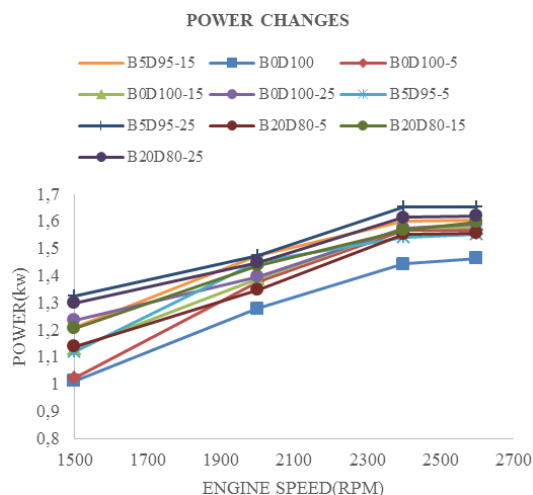

Fig. 6 The relationship between engine power-speed in different diesel-biodiesel-nanoparticle fuel blends

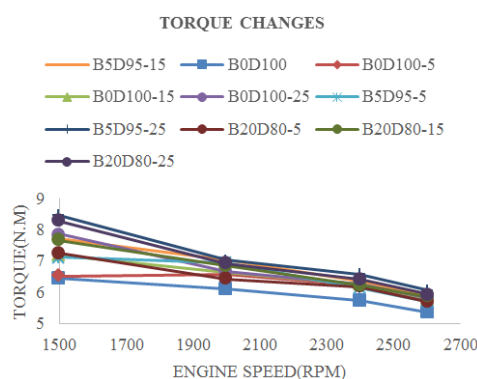

Fig. 7 The relationship between engine torque-speed in different diesel-biodiesel-nanoparticle fuel blends

C. Engine Fuel Consumption and Brake Specific Fuel Consumption

It is observed in Fig. 8 that fuel consumption amount of B20D80-5 compound in all speeds are less than other compounds. In contrast, B5D95-15 compound has the highest fuel consumption, which actually has an irregular behavior; up to 2000 rpm, fuel consumption is high, from 2000 to 2400 rpm, it decreases gradually, and from 2400 to 2600 rpm, it increases. It was expected that by increasing biodiesel amount in the compounds, given the fact that biodiesel heating value is less than diesel fuel, more amounts of fuel be consumed for producing the same amount of power. However, it was not true. The reason can be the existence of the used nanoparticles. In all compounds except B20D80-5 and B5D95-15, by increasing engine speed, no significant changes

were observed. It is seen in Fig. 8 that when B5D95-15 fuel compound is used, specific fuel consumption is more than that in other compounds, and B20D80-5 compound has the lowest specific fuel consumption compared to other used fuel compounds. Of course in all compounds, no regular behavior is seen in speed changes.

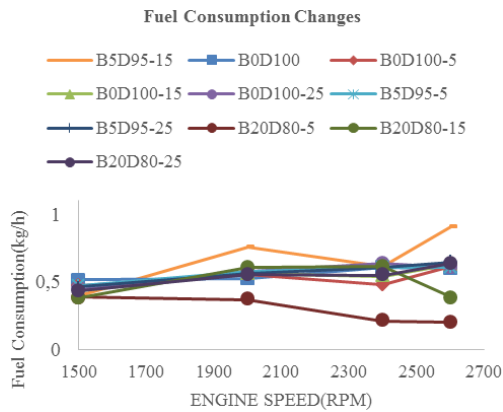

Fig. 8 The relationship between engine bsfc-speed in different diesel-biodiesel-nanoparticle fuel blends

IV. CONCLUSIONS

One of the methods to vary the physicochemical properties and combustion characteristics of a hydrocarbon fuel is the use of additives, which are found to be especially effective in nanoparticle form, due to the enhancement of the surface area to volume ratio. ASTM standard tests for the fuel property measurements and engine performance tests were reported in this paper for bio diesel modified by the addition of cerium oxide nanoparticles. Experiments were carried out at different dosing levels of the nanoparticle additives, to investigate the influences on the physicochemical properties, engine performance. The major observations and inferences are listed below.

- The bio diesel shows an increasing trend for the flash point with the dosing level, which indicates a successive decrease in the volatility of the fuel with increase in the quantity of the fuel additive this increase, is nearly linear. Higher flash point temperatures are desirable for safe handling of the fuel. In this context, and because of its higher flash point temperature, the fuels modified with cerium oxide nanoparticles are inherently safer than the base fuels.
- Viscosity of the fuels decrease with an increase for all dosing levels. The change in the viscosity of the fuel affects the engine performance as well as the hydrocarbon emissions. The fuel atomization is affected by the fuel viscosity, and the fuel with higher viscosity tends to form larger droplets on injection, which can cause poor combustion and increased exhaust smoke and emissions. Thus, the selection of the dosing level of the catalyst should be based on a compromise between these two mutually contradicting effects on the performance of the

engine. Also the cloud and pour points with the dosing levels are reduced.

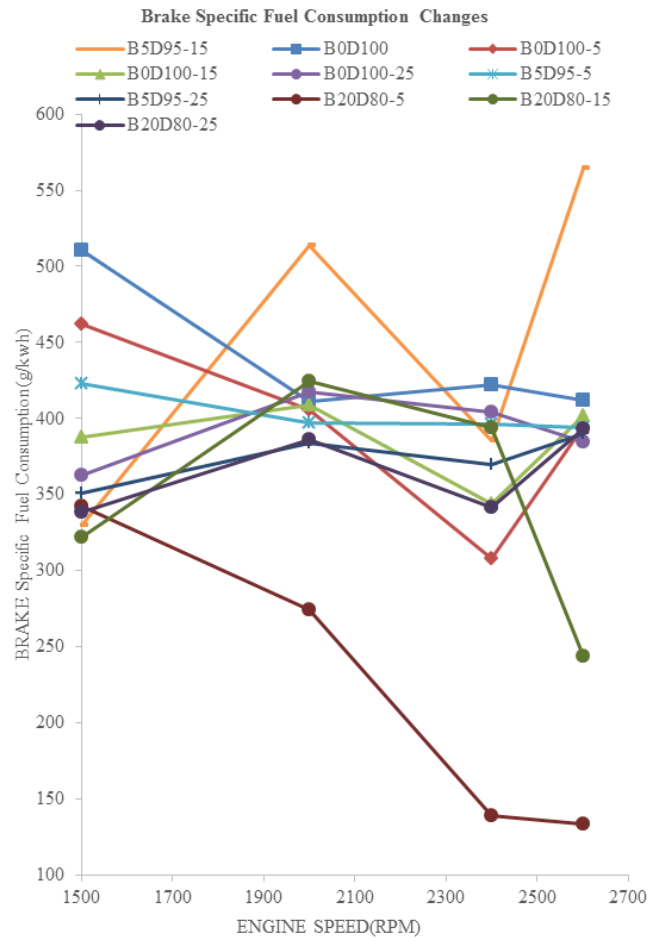

Fig. 9 The relationship between engine bsfc-speed in different diesel-biodiesel-nanoparticle fuel blends

- In all compounds, by decreasing revolution rate and increasing engine load, the amount of the resulted power has increased compared to pure diesel fuel. In general, up to 2400 rpm speed range, the power of mixtures increases gradually. In 2400 to 2600 rpm range, the power of mixtures decreases or in some compounds increases slightly. The same behavior applies for torque. By increasing engine speed, torque decreases gradually in all fuels. In these speed ranges, B5D95-25 mixture has the highest value and BOD100 fuel has the lowest value. By more increasing the speed, torque decreases and then remains constant in almost all mixtures.
- B20D80-5 compound has the highest fuel consumption reduction compared to other compounds. B5D95-15 compound has the highest fuel consumption. Of course no specific trend is observed in increasing fuel consumption and increasing biodiesel compound and nanoparticles and it requires more study.
- It shows the amount of changes in specific fuel consumption of the engine in each of the compounds compared to the pure diesel fuel. It is observed that

B20D80-5 compound has the highest specific fuel consumption reduction compared to other compounds. B5D95-15 compound has the lowest specific fuel consumption reduction. Specific fuel consumption is obtained by dividing fuel consumption rate by power.

- B5D95-25 compound has the highest amount of power and torque increase, while its specific fuel consumption increase is about 1.4% compared to pure diesel fuel. In higher percent of biodiesel and nanoparticles, B20D80-5 compound is a suitable compound due to having low fuel consumption and specific fuel consumption and relatively good power and torque.

REFERENCES

- [1] Prommes Kwanchareon, Apanee Luengnaruemitchai, Samai Jai-In. 2007. Solubility of a Diesel-Biodiesel-Ethanol Blend, Its Fuel Properties, and Its Emission Characteristics from Diesel Engine. *Fuel*. 86: 1053-1061.
- [2] Arul Mozhi Selvan V., Anand R.B., Udayakumar M. 2008. Stability and Performance Characteristics of Diesohol Using Biodiesel as Additive in Compression Ignition Engine. *Proc. of the Int. conference on Fascinating Advances in Mechanical Engineering, India*. pp. 667-673.
- [3] Heejung Jung, David B. Kittelson, Michael R. Zachariah. 2005. The Influence of a Cerium Additive on Ultrafine Diesel Particulate Emissions and Kinetics of Oxidation. *Combustion and Flame*. 142: 276-288.
- [4] Sanchez Escribano.V., Fernandez Lopez. E., Gallardo-Amores. J.M., Hoyo Martínez C. del., Pistarino.C, Panizza. M., Resini. C., Buscac. G. 2008. A Study of a Ceria-Zirconia-Supported Manganese Oxide Catalyst for Combustion of Diesel Soot Particles. *Combustion and Flame*. 153: 97-104.
- [5] Idriss H. 2004. Ethanol Reactions over the Surface of Noble Metal/Cerium Oxide Catalysts. *Platinum Metals Rev.* 48(3): 105-115.
- [6] Barry Park, Kenneth Donaldson, Rodger Duffin, Lang Tran, Frank Kelly, Ian Mudway, Jean Paul Morin, Robin Guest, Peter Jenkinson, Zissis Samaras, Myrsini Giannouli, Haris Kouridis, Patricia Martin, 2008. Hazard and Risk assessment of a Nanoparticulate Cerium Oxide based Diesel Fuel Additive-A Case Study. *Inhalation Toxicology*. 20(6): 547-566.
- [7] Melanie Auffan, Jerome Rose, Thierry Orsiere, Michel De Meo, Antoine Thill, Ophelie Zeyons, Olivier Proux, Armand Masion, Perrine Chaurand, Olivier Spalla, Alain Botta, Mark R. Wiesner, Jean-yves Bottero. 2009. CeO₂ Nanoparticles Induce DNA Damage towards Human Dermal Fibroblasts in vitro. *Nanotoxicology*. DOI: 10.1080/17435390902788086.
- [8] Ali Keskin, Metin Guru, Duran Altuparmak "Influence of Tall Oil Biodiesel with Mg and Mo Based Fuel Additives on Diesel Engine Performance and Emission" *Ersin University, Turkey, Bio Resource Technology* 99 (2008) 6434–6438.
- [9] ASTM D 445, "Test Method for Kinematic Viscosity of Transparent and Opaque Liquids".
- [10] ASTM 97-05a, "Test Method for Pour Point of Petroleum Products".
- [11] ASTM D92-05a, "Test Method for Flash and Fire Points by Cleveland Open Cup Tester".
- [12] Clark, S. L., Wagner, L. and Schrock, M. D. (1997). Methyl and Ethyl Soybean as Renewable Fuels for Diesel Engine. *JAOCS*, 10: 632-637.