

Experimental Study of LPG Diffusion Flame at Elevated Preheated Air Temperatures

A. A. Amer, H. M. Gad, I. A. Ibrahim, S. I. Abdel-Mageed, T. M. Farag

Abstract—This paper represents an experimental study of LPG diffusion flame at elevated preheated air temperatures. The flame is stabilized in a vertical water-cooled combustor by using air swirler. An experimental test rig was designed to investigate the different operating conditions. The burner head is designed so that the LPG fuel issued centrally and surrounded by the swirling air issues from an air swirler. There are three air swirlers having the same dimensions but having different blade angles to give different swirl numbers of 0.5, 0.87 and 1.5. The combustion air was heated electrically before entering the combustor up to a temperature about 500 K. Five air to fuel mass ratios of 15, 20, 30, 40 and 50 were also studied. The effect of preheated air temperature, swirl number and air to fuel mass ratios on the temperature maps, visible flame length, high temperature region (size) and exhaust species concentrations are studied. Some results show that as the preheated air temperature increases, the volume of high temperature region also increased but the flame length decreased. Increasing the preheated air temperature, EINO_x, EICO₂ and EIO₂ increased, while EICO decreased. Increasing the preheated air temperature from 300 to 500 K, for all air swirl numbers used, the highest increase in EINO_x, EICO₂ and EIO₂ are 141, 4 and 65%, respectively.

Keywords—Preheated air temperature, air swirler, flame length, emission index.

I. INTRODUCTION

COMBUSTION processes are the prime generator of energy in our civilization, which is burning fossil fuels at an ever-increasing rate. Fossil fuels remain the main source of energy for domestic heating, power generation, boilers, transportation, and other forms of industrial combustion, e.g. in furnaces. The combustion produces pollutants such as oxides of nitrogen (NO), CO, soot, and unburned hydrocarbon (HC). There are techniques for reducing NO and CO emissions levels such as combustion with a highly preheated air and low-oxygen concentration. These techniques provide significant energy savings reduce pollution and equipment size, and uniform thermal characteristics within the combustion chamber. However, the fundamental understanding of this technique is limited [1]-[3]. Many designs are used by combustion researchers to improve thermal efficiency, get stable flame, and controlled flames with low emissions and minimum cost. Furnaces used in industries such as aluminum, glass, steel and other metal casting need improving thermal efficiency and reduction pollutant emission. Preheated air combustion can be

used in industrial furnaces and regenerative combustion systems due to it is considered to be an emerging technique of reducing emission levels while enhancing combustion efficiency [4], [5].

Kumar and Mishra [5] studied experimentally the effect of adding H₂ into composite LPG-H₂ fuel jet diffusion flame with preheated reactants. The inlet temperature is preheated to 470K. The results indicated that by increasing H₂ addition, the flame length reduced and the peak gas temperature increased. It is noted that with increasing preheated air and reactants the flame length reduced and the peak gas temperature increased. The NO_x emission level reduces with H₂ addition. In contrast emission index (EINO_x) is observed to be enhanced with preheating of air and preheating reactants as compared to unheated case.

The effect of oxidant preheating and diluting on propane/oxygen and natural gas/oxygen laminar diffusion flames are experimentally investigated by [6]. Oxidant preheated up to 480K and compared with non-preheated tests. Preheating increases flame stability with respect to dilution process. The results show that preheating process increases flame maximum temperature and also luminous increases as compared to normal temperature flame. Lim, Gore, and Viskanta [7] investigated the effects of air preheat on flame structure in counter flow methane-air diffusion flames. The air temperatures change from 300 to 560 K. The results show that, as the air temperatures increase, both the measured and the predicted NO profiles showed approximately a 70% increase in the peak mole fractions.

Reddy [8] studied experimentally the effect of preheated air on the structure of coaxial jet diffusion flame. Liquefied Petroleum Gas (LPG) is used as the fuel. The results show that, by increasing the preheated air temperature, the flame length decreases, the CO concentration decreases and the NO_x concentration in the flue gas increases as it depends on the flame temperature and residence time in the high temperature region. Also, the flame is totally yellow in color, almost without any blue flame base.

Mohammad Ghaderi [3] studied experimentally the effects of preheated combustion air on laminar co flow diffusion flames under normal and low-gravity conditions. The results show that increasing the combustion air temperature by 400 K (from 300K to 700 K), causes a 37.1% reduction in the flame length and about a 25% increase in peak flame temperature. It can be concluded that preheating the combustion air increases the energy release intensity, flame temperature, C₂ concentration, and, presumably, NO_x production. Lamige, Galizzi, André, Baillot, and Escudié [9] studied experimentally

A. A. Amer, H. M. Gad, I. A. Ibrahim, S. I. Abdel-Mageed and T. M. Farag are with the Mechanical Power Engineering Department, Faculty of Engineering, Suez Canal University, Ismailia, Egypt (phone: +201222431596, +201007254810, +01005154486, +201222705234, e-mail: eng.ahmed_amer@yahoo.com, hamada_zzdd@yahoo.com, hema_bb76@yahoo.com, si_mageed@yahoo.com, faragtm@yahoo.com).

the impact of preheating and dilution on methane/air non-premixed flame stability. The initial reactant temperature is between 295 K and 850 K. Four diluents gases are added on the air-side, either CO₂, N₂, Ar or a (CO₂ + Ar) mixture having the same molar heat capacity as N₂. It is shown that flame stability is increased with preheating and dilution, since an attached flame is able to sustain much higher jet velocities with higher initial reactant temperatures.

An experimental and modeling study of burner-stabilized flames was conducted to understand the effect of preheat on syngas production by Smith, Pineda, and Ellzey [10]. The effect of preheat was studied by preheating reactants up to 630 K while holding the inlet velocity and equivalence ratio constant. Experiments show that preheating of reactants increased the rich limit for stable operation from 1.26 to 1.75 for a given inlet velocity, and syngas yields were shown to increase with equivalence ratio. It was also found that further preheat does not enhance syngas production.

The main objective of the present work is to study the effect of preheated air temperature on the gaseous fuel (LPG) diffusion flame at different air mass ratios and different air swirl numbers. The combustion air is heated electrically to a temperature up to about 500 K. The studied air to fuel mass ratios and the swirl numbers are 15-50 and 0.5 -1.5, respectively.

II. EXPERIMENTAL TEST RIG

The experimental test rig consists of air and commercial LPG fuel lines, air swirler and vertical tube water-cooled combustor. The schematic diagram of the experimental test rig is shown in Fig. 1. The air line consists of air blower, control valve, air duct, U-tube water manometer, and electrical heat

source unit for preheating air. The LPG fuel line consists of cylinder, gas regulator valve, gas hoses, pressure regulator valve, pressure gauges, an orifice and the fuel nozzle. The main chemical compositions of the commercial LPG fuel are Butane and Propane fuels of 90 and 10% by volume, respectively. The burner head was fitted coaxially with the combustor of 200 mm inner diameter and 1225 mm in length. The burner head is designed so that the LPG fuel issued centrally and surrounded by the swirling air issues from an air swirler.

The air flow rate is controlled and measured by using a control valve and a U-tube water manometer connected to an orifice meter. An air preheating unit (APU) is used to heat the combustion air for different preheated air temperatures. The air preheating unit consists of five electrical heaters, steel pipe, insulation, and automatic electric switches with lighting lamps. The total power of all the electrical helical coil heaters is 10 kilowatts and the power of each electrical heater is 2 KW. These electrical heaters have been placed inside iron pipe of length 1000 mm and 100 mm in diameter.

There are five automatic electric switches and five lighting lamps are connected to the five electrical heaters. The temperature of air is controlled by using specified number of electrical heaters. The electrical heaters are calibrated by changing the air mass flow rate with changing number of electrical heaters. The construction and assembly of air preheating unit is shown Fig. 2. The inlet temperature of combustion air was measured by using a digital thermometer.

The air swirler is used in the present work. The objective of the air swirler is control the stability and intensity of combustion and the size and shape of the flame region. The dimensions and detailed construction of one of the used swirlers are shown in Fig. 3.

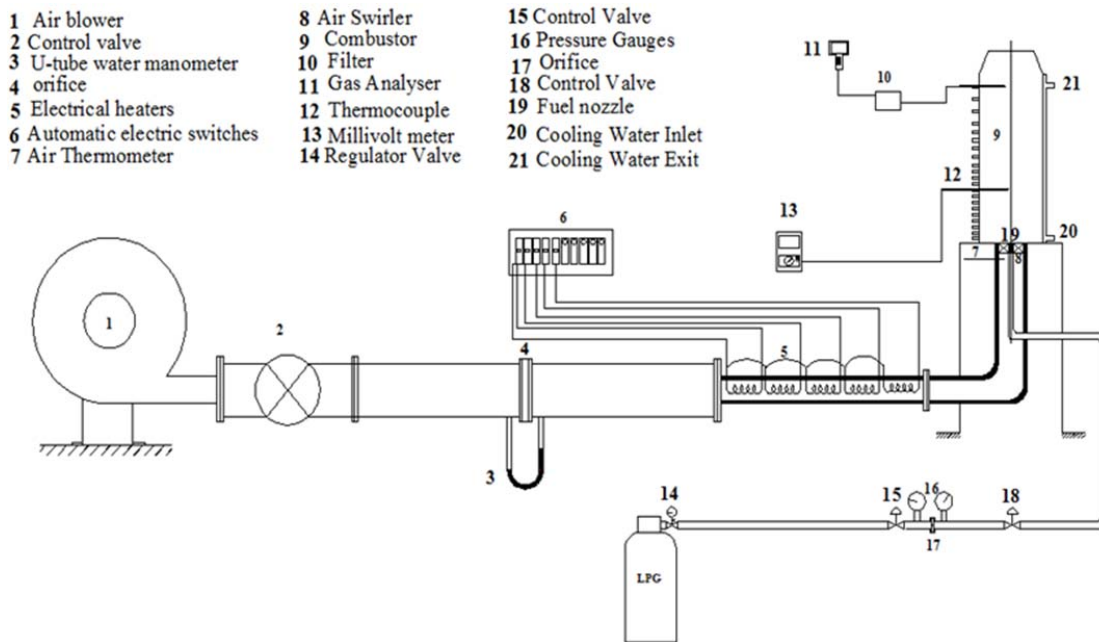

Fig. 1 Experimental test rig

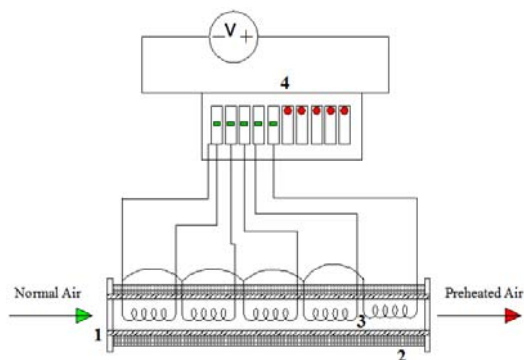

Fig. 2 Air preheating unit (1-Steel pipe, 2-Insulation, 3-Electrical heaters, 4-Automatic electric switches)

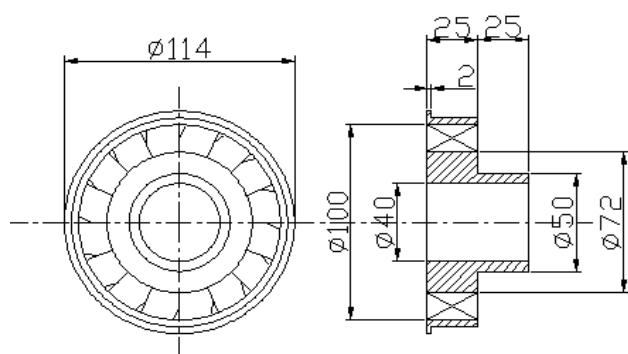

Fig. 3 Dimensions and detailed construction of the combustion air swirler, (Dimensions in mm)

The dimensions and assembly of the combustion chamber are shown in Fig. 4. The test section is water-cooled, vertical, cylindrical steel tube of 200 mm inner diameter and 1225 mm long. The combustor has a twenty three measuring tapings distributed along its length as shown in the figure.

III. EXPERIMENTAL RESULTS AND CONCLUSIONS

A. Temperature Distributions (Temperature Maps)

The temperature distributions of the flame are measured at both radial and axial directions along the flame to obtain complete feature of temperature patterns. The temperature maps and isothermal contours of temperature are chosen due to it is a good description for the temperature distribution inside the combustor in radial and axial directions. Surfer program is used to draw the radial and the axial temperatures distributions at the different operating conditions. The temperature is measured by a water-cooled Pt/Pt (13%Rh) type R bare wire thermocouple of 0.3 mm diameter.

1. Effect of Air to Fuel Mass Ratio on Temperatures Distributions

The effect of changing air to fuel mass ratio of 15,20,30,40 and 50 for air swirl numbers of 0.5 and 1.5 on temperature distributions are studied in the present section. The temperatures distribution in the radial and axial directions for different air to fuel mass ratios at air swirl number of 0.5 is shown in Fig. 5. It is shown that the region of high temperatures (1300 to 1400 K) is found at air to fuel mass ratios equals and

more than of 20. This region is not appeared in small air to fuel mass ratio of 15 due to the small amount of combustion air leading to bad combustion. For fuel mass ratio of 15, the flame color is light yellow at the bottom of combustor and orange close to red from the middle of combustor to the top. The flame diameter is very thin at the combustor end.

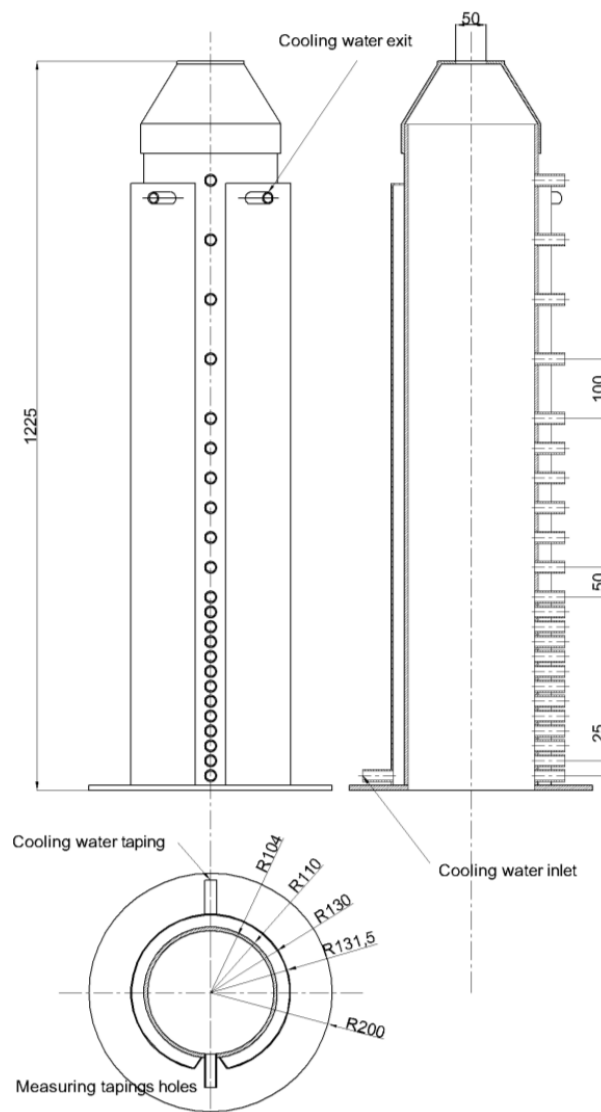

Fig. 4 Combustor dimensions and tapping ports, (Dimensions in mm)

The flame became shorter and the high temperatures region shifts upstream and became nearest to the burner when the air to fuel mass ratio increases and the flame temperatures generally decrease. This decreasing in the temperature is due to increasing of the quantity of combustion air. The reduction in flame length is due to increasing the combustion air mass flow rate, which increasing the reversed axial velocity which in turn the mixing and the chemical reaction increased.

The temperatures distribution in the radial and axial directions for different air to fuel mass ratios at higher air swirl number of 1.5 is shown in Fig. 6. The region of high temperatures (1300 to 1400 K) shifts upstream nearest to the air

swirler by increasing the air to fuel mass ratio. When the combustion air mass flow rate increased, the axial velocity increased, the mixing rate increased, and chemical reaction rate also increased, so the time of combustion is reduced and flame length is consequently, reduced. Also the reversed axial

velocity of the recirculation hot gases is increased causing a reduction in flame length. The low temperatures region (700 to 800 K) is found at the burner exit and it decreased with increasing air to fuel mass ratio.

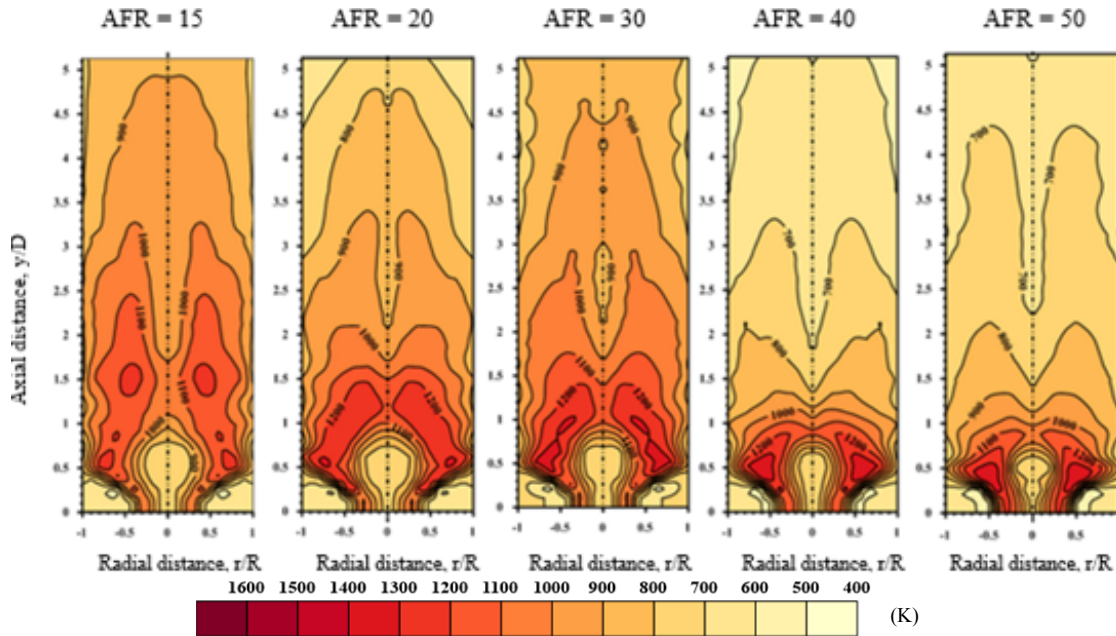

Fig. 5 Effect of air to fuel mass ratio on temperatures maps at air swirl number of 0.5 and combustion air temperature of 300 K

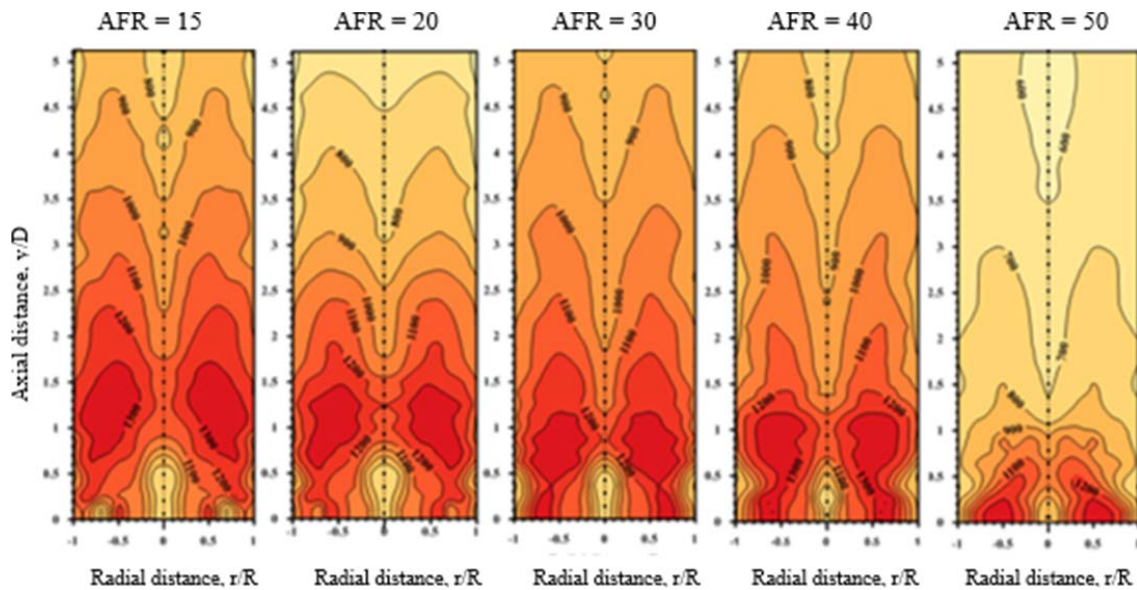

Fig. 6 Effect of air to fuel mass ratio on temperatures maps at air swirl number of 1.5 and combustion air temperature of 300 K

2. Effect of Air Swirl Number on Temperatures Distributions

To study the effect of swirl number on temperatures distributions, the fuel flow rate and air mass flow rate maintained constant. Three air swirlers are used in the experimental study which having blade angles of 30°, 45° and 60° to give air swirl numbers of 0.5, 0.87, and 1.5, respectively. The swirl number of an annular swirler with constant setting vane angle α can be determined from an expression given by

[11]. Three experimental runs are implemented to quantify the air swirl number effect on the temperatures patterns. During these runs, the other operating conditions are kept constants such as air to fuel mass ratio equals 30 and combustion air temperature of 300 K and 400 K.

The temperatures distribution in the radial and axial directions for air swirler numbers of 0.5, 0.87, and 1.5 and at constant air to fuel mass ratio of 30 are shown in Fig. 7. It is

shown that, the region of high temperatures (1300 to 1400 K) is shifted upstream nearest to the burner, it is moved inward to center line, and it is increased in volume by increasing air swirler numbers. Small size of low temperature region appeared at the nozzle exit and at the inlet combustor wall. By increasing the air swirl number, the volume of both regions decreased as shown for air swirl number of 1.5 due to wider flame appeared. It is shown that, the flame length reduced due to the stronger of the recirculation zone and the increasing of the mixing rate resulting from increasing the air swirl number.

The temperatures distribution in the radial and axial directions for air swirler numbers of 0.5, 0.87, and 1.5 at preheated air temperature of 400 K at constant air to fuel mass ratio of 30 are shown in Fig. 8. The high temperature regions can be divided into two regions; the first region of the high temperatures is changed from 1300 to 1400 K and the other region of the high temperatures is changed from 1400 to 1500 K. It is noted that, the high temperature region is increased in diameter by increasing the air swirl number and it is shifted upstream toward the burner due to increasing the mixing rate.

Comparing between the two Figs. 7 and 8, increasing the preheating temperature from 300 to 400 K the whole flame temperatures also increased due to the increase in chemical reaction rate.

B. Volume of High Temperatures Region

The volume for the high temperature regions is estimated from the temperatures map as an indication for the heat released from combustion. The amount of heat released indicates to the combustion quality. The volume, V_h , of the high temperatures region is calculated for the temperature ranges from 1300 to 1600 K. The volume, V_h , is indicated as dimensionless by dividing it by the combustor volume.

The effect of the preheated air temperature on the volume ratio (V_h /combustor volume, V_c) of the high temperatures region for different air swirl numbers and constant air to fuel mass ratio of 30 is shown in Fig. 11. The volume ratio of the high temperatures region is increased by increasing the preheated air temperature for all different air swirl numbers. Increasing the preheating temperature from 300 to 500 K, the volume ratio increased by about 432, 149 and 133 % for swirl number 0.5, 0.87 and 1.5, respectively. The increase in the volume ratio of the high temperatures region is higher for swirl number 0.5 than that of the others one.

It is found also that, the highest and the lowest values of the volume ratio, V_h/V_c , are about 18, 11, and 9 %, and 8, 5, and 2 % for air swirl numbers of 1.5, 0.87, and 0.5, respectively. When the preheated air temperature is increased, the chemical reaction rate is increased, and then consequently the time of combustion is reduced which leading to good combustion, the heat released is increased, the flame temperature levels are increased and then consequently increasing the volume of the high temperatures region.

The effect of preheated air temperature on the visible flame length at AFR = 30 and different air swirl numbers is shown in Fig. 14. Increasing preheated air temperature from 300 to 500 K (66.7 %), the flame length decreased by about 45, 42 and 26%, for air swirl numbers of 0.5, 0.87 and 1.5, respectively. It found that, the reduction in flame length when increasing preheated air temperature at strong air swirl number of 1.5 is lesser than the reduction in the other ones. The reduction in flame length at air swirl number of 0.5 and 0.87 is clear because the flame size is large. When preheated air temperatures increased, the chemical reaction rate increased and then the time of combustion reduced leading to reduction in flame length.

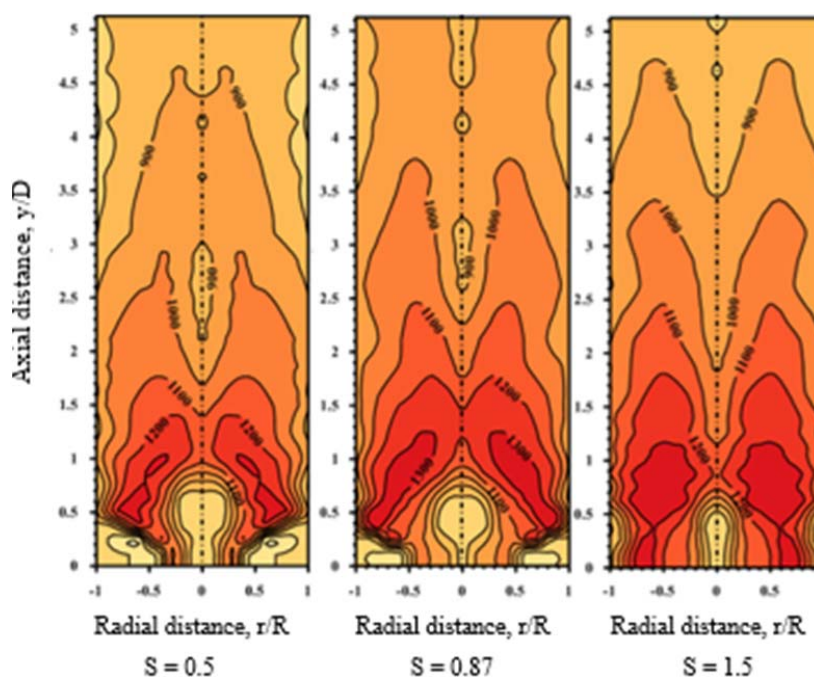

Fig. 7 Effect of air swirl number on temperatures maps at AFR = 30 and combustion air temperature of 300 K

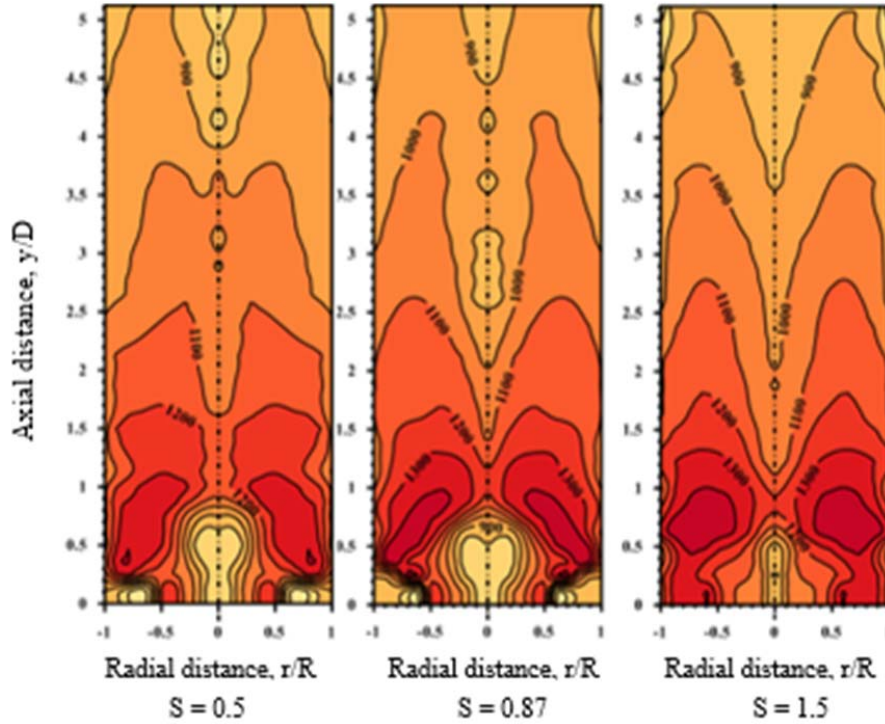

Fig. 8 Effect of air swirl number on temperatures maps at AFR = 30 and preheated air temperature of 400 K

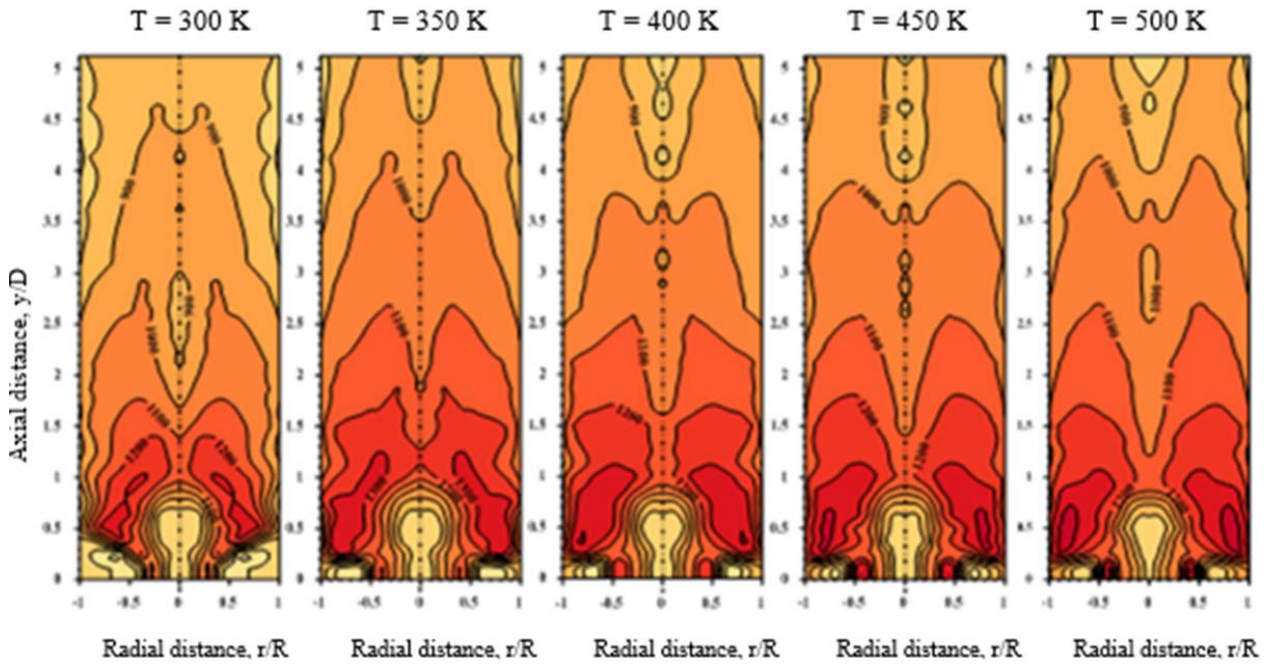

Fig. 9 Effect of preheated air temperatures on temperature maps at air swirl number of 0.5 and AFR of 30

C. Exhaust Species Concentrations

In the present study, the exhaust species concentrations such as NO_x , CO_2 , CO and O_2 were measured by a digital gas analyzer (Model Type Testo350). These species concentrations are measured in the end of combustor at the last measuring tapping point to avoid the effect of the atmospheric air in the measurement. The value of each species concentration was

recorded. The effect of preheated air temperature on the emission index of (NO_x , CO_2 , CO and O_2) is studied.

The emissions were represented as emissions index that defined as the amount of the mass of species i measured to the mass of fuel burned by the combustion process. Assuming all of the fuel carbon appears as either CO_2 or CO , the emission index is estimated as:

$$E_{li} = \left(\frac{x_i}{x_{co} + x_{co_2}} \right) \left(\frac{n \times MW_i}{MW_f} \right)$$

where X_i is mole fraction of the i th species in the flue gas; n is the number of moles of carbon in a mole of fuel, MW_i and MW_f are the molecular weight of i th species and fuel, respectively [5], [12].

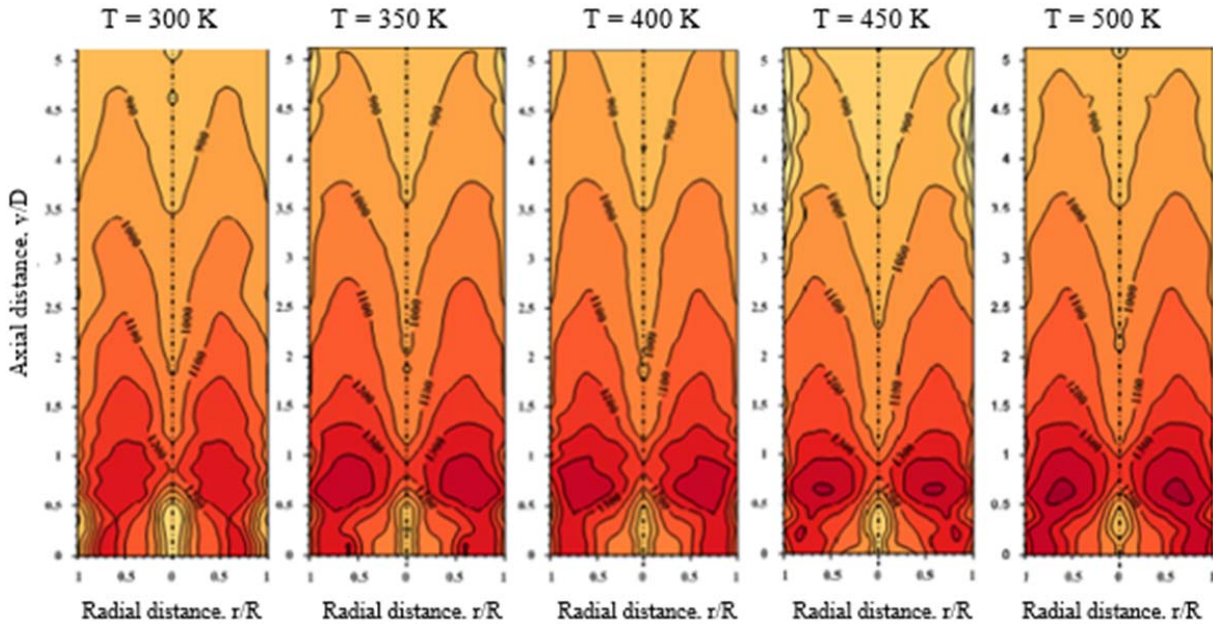

Fig. 10 Effect of preheated air temperature on temperatures maps at air swirl number of 1.5 and AFR of 30

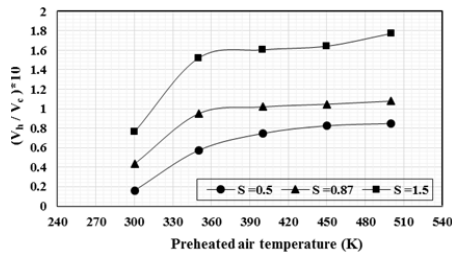

Fig. 11 Effect of preheated air temperature on the volume of the high temperatures region at different air swirl numbers and air to fuel mass ratio of 30

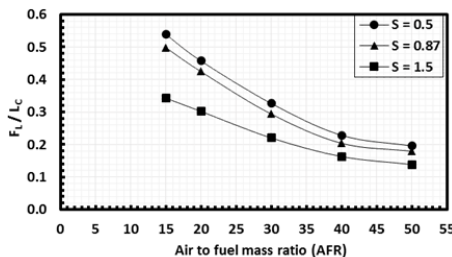

Fig. 12 Effect of air to fuel mass ratio on the flame length for different air swirl numbers

The effect of preheated air temperature on the emissions index at air to fuel mass ratio of 30 and swirl numbers of 0.5, 0.87, and 1.5 is shown in Figs. 15-18. It is shown that, increasing the preheated air temperature, E_{NOx} , E_{ICO_2} and E_{IO_2} increased, but E_{ICO} decreased. At given air swirl number 0.5, Figs. 15-18 show that increasing the preheated air

temperature from 300 to 500 K, E_{NOx} , E_{ICO_2} and E_{IO_2} increased by about 67, 4.0, 59%, respectively while E_{ICO} decreased by about 92%. At air swirl number of 0.87, increasing the preheated air temperature from 300 to 500 K, E_{NOx} , E_{ICO_2} and E_{IO_2} increased by about 141, 0.4, 49%, respectively while E_{ICO} decreased by about 67%. At air swirl number of 1.5, increasing the preheated air temperature from 300 to 500 K, E_{NOx} , E_{ICO_2} and E_{IO_2} increased by about 56, 0.04, 65%, respectively while E_{ICO} decreased by about 33%.

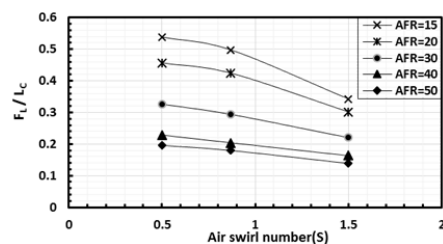

Fig. 13 Effect of air swirl number on flame length for different air to fuel mass ratios

In general, increasing the preheated air temperature, the E_{NOx} , E_{ICO_2} and E_{IO_2} increased, but E_{ICO} decreased.

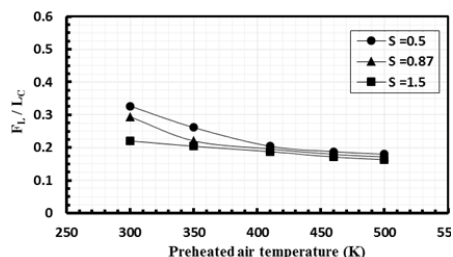

Fig. 14 Effect of preheated air temperature on flame length for different air swirl number and air to fuel mass ratio of 30

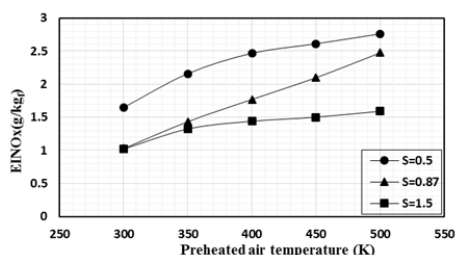

Fig. 15 Effect of preheated air temperature on the EINOx at air swirl numbers of 0.5, 0.87, and 1.5 and at air to fuel mass ratio of 30

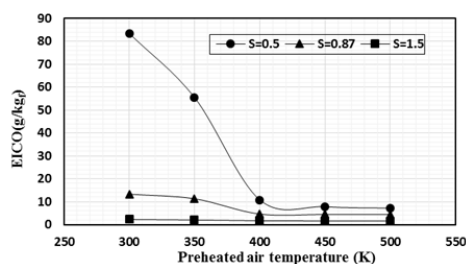

Fig. 16 Effect of preheated air temperature on the EICO at air swirl numbers of 0.5, 0.87, and 1.5 and at air to fuel mass ratio of 30

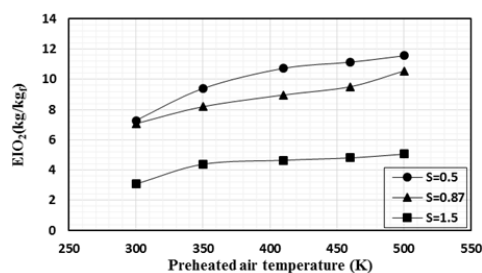

Fig. 17 Effect of preheated air temperature on the EIO₂ at air swirl numbers of 0.5, 0.87, and 1.5 and at air to fuel mass ratio of 30

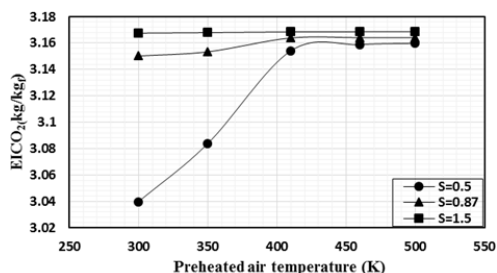

Fig. 18 Effect of preheated air temperature on the EICO₂ at air swirl number of 0.5, 0.87, and 1.5 and at air to fuel mass ratio of 30

VI. CONCLUSIONS

From the experimental results, the main conclusions can be obtained.

1. Increasing the air to fuel mass ratio from 15 to 50, the flame length decreases by about 64, 62, and 60% for air swirl numbers of 0.50, 0.87, and 1.50, respectively.
2. Increasing the air swirl number from 0.5 to 1.5, the flame length decreases by about 37% at AFR=15 and combustion air inlet temperature of 300 K.
3. Increasing the preheated air temperature from 300 to 500 K, the chemical reaction rate increases and then the time of combustion reduces which consequently leading to increasing the flame temperature levels and then consequently increasing in the volume of the high temperatures region, while decreasing in the flame length. The flame length is decreased by about 45, 42 and 26% for air swirl numbers of 0.50, 0.87, and 1.50, respectively. The volume of the high temperatures region ratio increased by about 432% for air swirl number of 0.50. The highest value of the volume of the high temperatures region ratio is about 18% for air swirl number of 1.50 and preheated air temperature of 500K. The EINOx, EICO₂ and EIO₂ increase, while EICO decreases. The highest reduction in EICO is 92% at air swirl number of 0.50 and the highest increase in EINOx is 141% at air swirl numbers of 0.87.

REFERENCES

- [1] P. Dockrill, and F. Friedrich, "Boilers and Heaters: Efficiency, Improving Energy," 2001.
- [2] N. Peters, "Turbulent Combustion" Cambridge University Press, 2000.
- [3] Y.M Ghaderi., "Effects of Preheated Combustion Air on Laminar Coflow Diffusion Flames under Normal and Microgravity Conditions," Ph.D. Thesis, Maryland, 2005.
- [4] H. M. Gad, "Study of Combustion Characteristics of Diffusion Flame Using Different Gaseous Additives in Air Stream," M.Sc. Thesis Mechanical Power Engineering Suez Canal University, 2004.
- [5] D. Mishra and P. Kumar, "Experimental Investigation of Laminar LPG-H₂ Jet Diffusion Flame with Preheated Reactants " Fuel, Vol. 87, pp. 3091-3095, 2008.
- [6] B. Kashir., S. Tabejamaat, and M. M. Baig, "Experimental Study on Propane/Oxygen and Natural Gas/Oxygen Laminar Diffusion Flames in Diluting and Preheating Conditions," Thermal Science, Vol. 16, Pp. 1043-1053, 2012.
- [7] J. Lim, J. Gore, and R. Viskanta, "A Study of the Effects of Air Preheat on the Structure of Methane/Air Counter Flow Diffusion Flames," Combustion and Flame, Vol. 121, Pp. 262-274, 2000.
- [8] S. S. Reddy, "Effect of Preheated Air on the Structure of Coaxial Jet Diffusion Flame," International Archive of Applied Sciences & Technology, Vol. 4, 2013.
- [9] S. Lamige, C. Galizzi, F. André, F. Baillet, and D. K. Escudie, "On Preheating and Dilution Effects in Non-Premixed Jet Flame Stabilization," Combustion and Flame Vol. 160, 6, Pp. 1102-1111, 2013.
- [10] C.H. Smith, D.I. Pineda, and J. L. Ellzey, "Syngas Production from Burner-Stabilized Methane/Air Flames: The Effect of Preheated Reactants," Combustion and Flame Vol. 160 Pp. 557-564, 2013.
- [11] Beer J. M. and Chigier, "Combustion Aerodynamics", Applied Science Publisher, London, 1972.
- [12] S. R. Turns, "An Introduction to Combustion: Concepts and Applications." Ed: Mcgraw-Hill, New York, 1996.