

# Performance Evaluation of Discrete Fourier Transform Algorithm Based PMU for Wide Area Measurement System

Alpesh Adeshara, Rajendrasinh Jadeja, Praghnessh Bhatt

**Abstract**—Implementation of advanced technologies requires sophisticated instruments that deal with the operation, control, restoration and protection of rapidly growing power system network under normal and abnormal conditions. Presently, the applications of Phasor Measurement Unit (PMU) are widely found in real time operation, monitoring, controlling and analysis of power system network as it eliminates the various limitations of supervisory control and data acquisition system (SCADA) conventionally used in power system. The use of PMU data is very rapidly increasing its importance for online and offline analysis. Wide area measurement system (WAMS) is developed as new technology by use of multiple PMUs in power system. The present paper proposes a model of Matlab based PMU using Discrete Fourier Transform (DFT) algorithm and evaluation of its operation under different contingencies. In this paper, PMU based two bus system having WAMS network is presented as a case study.

**Keywords**—DFT-Discrete Fourier Transform, GPS-Global Positioning System, PMU-Phasor Measurement System, WAMS-Wide Area Monitoring System.

## I. INTRODUCTION

THE phasors are widely used in power system for analysis of the alternating quantities with the assumption of constant frequency since many years [1]. Currently new technique known as synchronized phasor measurement is developed that uses WAMS for different power system applications by using PMU [2]. PMU measures positive sequence voltage and current which provides instantaneous state of power system and therefore PMU is more advantageous than a conventional SCADA system for various power system applications [3].

A reliable, effective and most importantly, affordable transmission systems are required to deliver the power to the consumer from the generating stations. The problem of grid congestion, system reliability and increase in cost rises if more power is transmitted per line. However, if above problems predominate, they may result in system instability, blackouts or rolling blackout, communication failure etc.

This is not a desirable condition and ultimately numbers of power plants have to be shut down due to cascading effects. During the survey of blackouts, the main reasons found were

Alpesh Adeshara is PhD Scholar, School of Engineering, R. K. University, Rajkot, Gujarat, India (e-mail: alpeshsays@yahoo.com).

Rajendrasinh Jadeja is Dean of Faculty of Engineering, Marwadi Education Foundation, Rajkot, Gujarat, India (e-mail: rbjadeja2001@gmail.com).

Praghnessh Bhatt is Professor of Department of Electrical Engineering, CSPIT, Changa, Gujarat, India (e-mail: praghnesshbhatt.ee@charusat.ac.in).

the inefficiency of the system and responding capacity of operator in such a condition. Therefore, it was possible to prevent these blackouts and also boosting immunity to cascading would have been possible. [4].

Nowadays, the power system becomes very complex and numbers of operations are required simultaneously. The energy demand is increasing very quickly. So, the only way is to either the power generation is required to increase or the efficiency of the existing system has to be increased by establishing smart grid. Power generation is concerned with so many non-technical factors like government policies, initial high cost etc. So, to improve the efficiency by smart grid is the only way to implement. For improvement in power system reliability, continuous monitoring of the system as well as training and enforcement of standards within the system are essential. Due to which, in critical situations, a quick response can be possible over a largest area within the shortest period of time with minimum affecting human interference. So, Wide Area Monitoring, Control and Protection system which is a form of the smart grid are required to maintain a secure system state means the system can survive for each specified contingency [5].

Today, WAMS is becoming more popular in the latest technologies for upgrading the traditional electric grid. All around the world, it is very necessary to modernize the electricity delivering system. However, there are various algorithms developed in the early period for real time monitoring of power systems\_network with the evaluation of working frequency. Before 1990s, the first time, a synchronized phasor measurement unit (PMUs) was introduced [6]. These PMUs, in wide area measurement systems, become the vital data acquisition technology with a lot of applications at present under development around the world [7], [8].

Various electrical industries in the world are facing some serious problems like grid reliability and transmission congestion. To face above mentioned operational challenges within the industries SCADA has been used in smart grid with varying security devices [9]. But the reporting rate of the SCADA system is very slow which make difficult to analyze the power system in a dynamic state. Hence, phasor technology is one of the advanced tools in this area which improve overall performance of the power system. By applying PMU with very high sampling rate (30 samples per seconds), snapshots of a power system for different behaviors are taken because instantaneous data is the heart of real time

estimation. In this way, WAMS balances existing SCADA system by giving resolution of micro seconds as well as larger perspective to cater with the needs of monitoring for wide area, with continuous application of SCADA. The main advantage of using the WAMS is that the actual system states can be measured and it performs very precisely without relying on offline studies for its assessment and comprehensive system models, which would be outdated as well as inaccurate [10].

The objective of this paper is to present a Matlab based PMU, which uses DFT algorithm and to explore its application for WAMS. The Matlab platform can process simulated power system WAMS based network. It is proposed that this simulated network will present a hands-on understanding for the algorithms and substitution involved in the phasor measurement process. Finally, the proposed PMU performance is verified under different operating scenarios.

The paper is organized as follows: Section II presents PMU basics and its architecture, Section III describes PMU application in WAMS and Section IV demonstrates the proposed MATLAB based PMU with DFT algorithm. The test system, results and discussion of the proposed approach are contained in Section V. Section VI deals with a conclusion.

## II. PMU BASICS AND ITS ARCHITECTURE

Synchrophasor provides information of voltage or current phasor with reference to time. The information is in the form of time signal provided by global positioning system (GPS) and this signal is generated at 1 pulse per second (1 pps) by GPS [11]. There is not much significance of the phasor angle with the arbitrary time signal, simply by collecting all PMUs output at the same timing reference gives the phase angle difference between phasors are and it will provide data helpful for monitoring & control of the power system [12]. The first prototype of PMU was installed at Virginia Tech. and Macrodyne using phasor measurement technique (model 1690) [13].

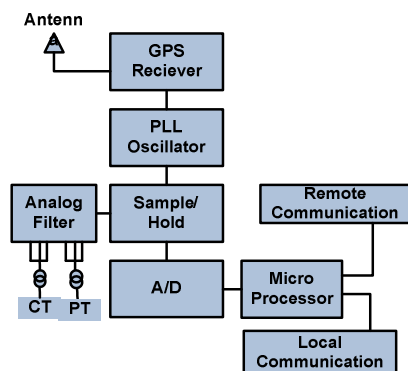

Fig. 1 Phasor Measurement Unit Architecture

The requirements for PMU performance are reported in various standards [14]-[15]. The former standard only introduces a requirement for PMU steady state performance,

but later on it has been revised to analyze dynamic behavior of power systems.

## III. PMU APPLICATIONS IN WIDE AREA MEASUREMENT SYSTEM

The conventional method (SCADA) used in power system application has some limitations such as the limitations of control techniques, algorithms, operational boundaries, data measurement speed and accuracy. So, it is very difficult to get real time system behavior or to make a dynamic analysis of the power system. Recently, the WAMS has become the powerful system to do the real time monitoring and for control of the power system. Some applications of PMUs are listed below to improve power system performance:

### A. Visualization Tool/ Power System Event Analysis

The main and very useful application of synchrophasor unit (PMU) is Wide area measurement systems (WAMS). This system refers to the possibility of visualizing a wide area of the electrical grid with PMUs [16]. From measured data, a surface plot of an angle measured can be possible by using PMUs which are located in widely dispersed location across a power system. As the earlier power system did not have time synchronized recorders and loggers, it is difficult to analyze the event. But in WAMS, a GPS based PMU is used for time synchronization that cuts down time coordination problem from hours to seconds [17].

### B. Power System State Estimation

The state variables of the power system can be measured with the help of State Estimation. With the help of that the operator can compare the estimated value with the measurement set and this can become an essential tool for any supply provider's control center. Before WAMS, power system state was not directly measured, but contingent using unsynchronized power flow data. But now with the WAMS, State estimation uses line data and its injections, real power and reactive power for bus voltage and its magnitude calculation. It also gives high accuracy compared to SCADA system and sturdiness of bad data. In WAMS with PMU gives state estimation for all the phases during unbalance conditions [18], [19].

### C. Line Parameter Calculation

If we use the Wide area measurement system, the data at the end of the line can be used for line parameters calculation which helps in comparing design data also. Continuous monitoring of line parameter and its calculation helps in modeling, fault location detection [20] and for line outage detection [21].

### D. Real Time Congestion Management

In the real power system, to manage demand with the economic aspect without effecting transmission limits is very difficult. In power system, all the lines having their own thermal capability, voltage and stability margin which are pre calculated. Then, to run the power system in a true manner, line is compared with nominal transfer capacity. The real time

high speed and accurate data obtain with PMU can improve congestion management and reduces excessive margins [22].

#### E. Power System Protection

In conventional protection system, the system acted in response to faults irrespective of the existing condition in a predetermined manner. But Adaptive relaying assumes system characteristics and protection data should be coordinated with existing conditions. Out of step relays and line relays gives best protection and reliability [23]. PMU provides an accurate measure of line impedance for fault, location [24]. Moreover, the conventional power system, zone-3 distance relay or backup relay was operated by heavy loads and which forced to remove backup protection. But in WAMS, the backup zone is constantly supervised by PMUs and hence false tripping is avoided. PMU uses Wide area measurements to control for load swing or fault. But that coordinates with other PMUs measurements and differentiate fault and load swing [25].

#### F. Voltage Stability Monitoring

In the power system, voltage stability plays a major role because voltage instability for a long time led to blackouts. Therefore, voltage stability needs careful monitoring [26]. With the help of measurement taken from WAMS, voltage stability assessment becomes easy, fast, and precise. Moreover, the voltage monitoring taken by placing PMUs at each end of a transmission line become very easy tool and the power margin can be evaluated securing voltage stability on the line [27].

#### G. Power System Oscillation Monitoring

For the power system, small signal oscillations are very important to observe in real time, which are electromechanical oscillation caused by generator angles oscillating each other. In WAMS, this oscillation is observed by the frequency variation caused by the machine rotor and the frequency spectrum is calculated through DFT in PMUs. The electromechanical oscillation if remains for a longer time, it may damage the generator and thus it must be damped [28].

Also, PMUs is used to get depth observability. It means the voltage phasor and line current of the connected bus can be measured immediately. Moreover, the application of the PMU are greatly reduced the act of data acquisition equipments and tools required throughout the network.

### IV. MATLAB BASED PMU WITH DFT ALGORITHM

Discrete Fourier Transform (DFT) is used for estimating the Fourier transform of small number of samples for input signal  $x(t)$  [29]. On the real time in the power system, to achieve the voltage and current phasor synchronously, DFT algorithm has been used. Simulink blocks are used for finding out the positive sequence component from the available signals [30]. By using relationship of Fourier series coefficients with DFT algorithm, the phasor for  $k_{th}$  are obtained.

First of all DFT can be described by considering the Pure sinusoidal input signal in the following form:

$$x(t) = X_m \cos(\omega t + \theta) \quad (1)$$

where,  $\omega$  = frequency of signal (radian per second);  $\theta$  = phase angle (radian);  $X_m$  = Peak amplitude of the signal. So,  $X_m/\sqrt{2}$  is the RMS value of the signal  $x(t)$  and which is helpful to calculate active and reactive power for AC Network.

$$x(t) = Re (X_m e^{j(\omega t + \theta)}) \quad (2)$$

$$x(t) = [\{e^{j\omega t}\} X_m e^{j\theta}]$$

In (2), the term  $e^{j\omega t}$  can be ignored by considering the frequency is  $\omega$  and it can be represented by complex value X in terms of phasor representation.

$$X = X_r + jX_i \quad (3)$$

$$X = (X_m/\sqrt{2})(\cos \theta + j \sin \theta) \quad (4)$$

Now let's take the signal  $x(t)$  is sampled N times per period of 50Hz signal to generate the any order of harmonic component is given by,

$$X(k) = \frac{2}{N} \sum_{m=0}^{N-1} x(n) e^{-j 2\pi k m / N} \quad (5)$$

where,  $k$  = order of harmonic;

$N$  = Total number of sample per window;

$n$  =  $n_{th}$  no. of sample

$m$  =  $m_{th}$  no. of sample =  $(n - 1)_{th}$  no. of sample

$x(n)$  = Discrete signal

$$\omega = 2\pi f, f = \left(\frac{1}{T_s N}\right), \omega = \frac{2\pi}{T_s N}$$

$$\theta = \frac{2\pi}{NT} t = \frac{2\pi n}{N} \text{ (where } t = nT \text{)}$$

Now, (6) can be expanded using (5) and it is rewritten as:

$$X(k) = \left[ \frac{2}{N} \sum_{m=0}^{N-1} x(n) \cdot \cos\left(\frac{2\pi m}{N}\right) \right] - j \left[ \frac{2}{N} \sum_{m=0}^{N-1} x(n) \cdot \sin\left(\frac{2\pi m}{N}\right) \right] \quad (6)$$

For the RMS value,

$$X(k) = \frac{1}{\sqrt{2}} \left[ \frac{2}{N} \sum_{m=0}^{N-1} x(n) \cdot \cos\left(\frac{2\pi m}{N}\right) \right] - j \left[ \frac{2}{N} \sum_{m=0}^{N-1} x(n) \cdot \sin\left(\frac{2\pi m}{N}\right) \right]$$

$$X(k) = \left[ \frac{\sqrt{2}}{N} \sum_{m=0}^{N-1} x(n) \cdot \cos\left(\frac{2\pi m}{N}\right) \right] - j \left[ \frac{\sqrt{2}}{N} \sum_{m=0}^{N-1} x(n) \cdot \sin\left(\frac{2\pi m}{N}\right) \right] \quad (7)$$

The RMS value of amplitude for voltage or current signal and phase angle of any of these signals can be obtained as:  
Phase angle,

$$\theta = \tan^{-1} \left( \frac{\frac{\sqrt{2}}{N} \sum_{m=0}^{N-1} x(n) \cdot \sin\left(\frac{2\pi m}{N}\right)}{\frac{\sqrt{2}}{N} \sum_{m=0}^{N-1} x(n) \cdot \cos\left(\frac{2\pi m}{N}\right)} \right) \quad (8)$$

$$\text{RMS Amplitude, } X_{rms} = (X_r + X_i) / 2 \quad (9)$$

So, (7) gives the fundamental FFT equation to find out the any order harmonic component. PMU can only measure fundamental signals. So take  $k=1$  in the equation 1. Moreover, (6) is the expansion of (5) which gives real and imaginary part

of this FFT equation. Equation (8) gives the angle and (9) gives the RMS amplitude of measuring signal.

## V. TEST SYSTEM, RESULTS AND DISCUSSION

### A. Test System

In this proposed system 11kV Generator is connected with 100kW active load. Transmission line length between two buses is 50km and on each bus PMU is connected. Each PMU is synchronized with GPS and transfers data through the communication line.

TABLE I  
NETWORK SIMULATION PARAMETERS

Parameter	Value
Voltage Source	11kv
System Frequency	50 Hz
Transmission Line Length	50 km
Fault Timer	[0 0.5]
Fault Resistance	0.001 $\Omega$
RL branch Resistance	0.01 $\Omega$
RL branch Inductance	0.0031 H
Load	100kw
PT ratio	11000/110
CT ratio	1:1
Line Constant	$R_0 = 0.01273 \Omega / \text{km}; R_I = 1.03864 \Omega / \text{km}$ $L_0 = 0.9337 \text{mH} / \text{km}; L_I = 4.1264 \text{mH} / \text{km}$ $C_0 = 12.74 \text{nF} / \text{km}; C_I = 7.751 \text{nF} / \text{km}$

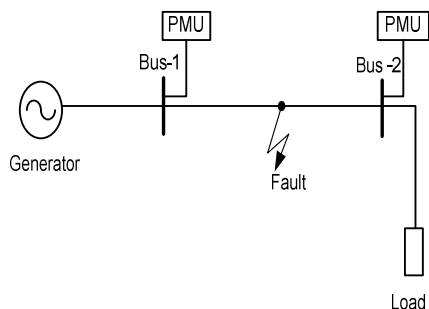

Fig. 2 Single Line Diagram of Two Bus Power System Network with PMUs

TABLE II  
CASE STUDIES FOR THE SIMULATED WAMS NETWORK

Case No.	Results	Events
Case-1	Voltage Phase Angle Comparison	Reference Signal during normal condition
		Single line to Ground fault (SLGF)
		Double line to Ground fault (DLGF)
Case-2	Voltage Magnitude Comparison	Triple line to Ground fault (TLGF)
		Harmonic Injection (HI)
Case-3	Current Phase Angle Comparison	Reference Signal during normal condition
Case-4	Current Magnitude Comparison	SLGF,DLGF,TLGF

### B. Results and Discussion

In the test system, four different contingencies are created to compare the behavior of variation of different parameters as per Table II. Here, reference signal generated in MATLAB

simulated PMU is compared with system signals during normal condition and it is observed that there is no deviation in Magnitude as well as Phase angle (Figs. 3 (a), 4 (a), 5 (a) and 6 (a)) means they are overlapped. Hence, for all contingencies, it is considered as a reference signal.

#### 1. Case-1

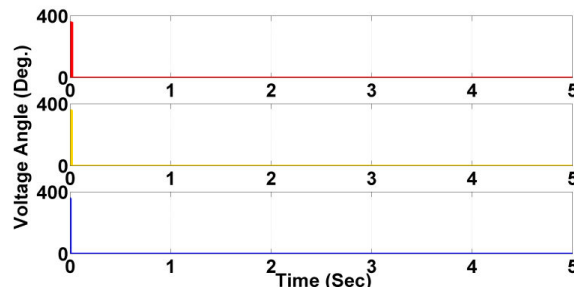

Fig. 3 (a)  $V_R, V_Y, V_B$  voltage phase angle during normal condition as a reference signal

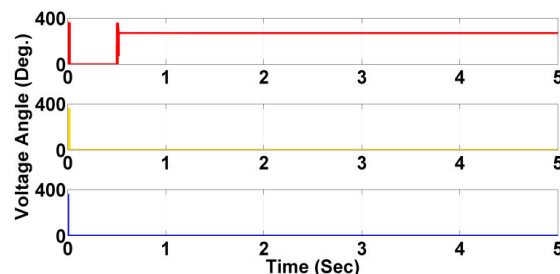

Fig. 3 (b)  $V_R, V_Y, V_B$  voltage phase angle during SLGF

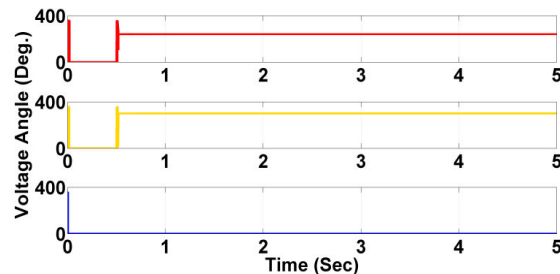

Fig. 3 (c)  $V_R, V_Y, V_B$  voltage phase angle during DLGF

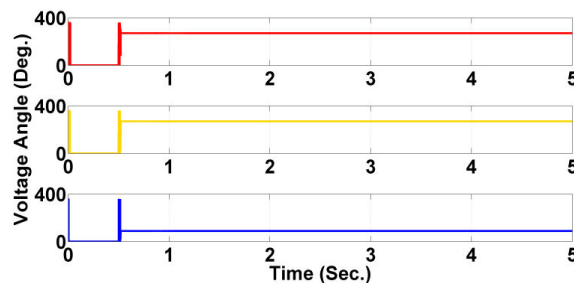

Fig. 3 (d)  $V_R, V_Y, V_B$  voltage phase angle during TLGF

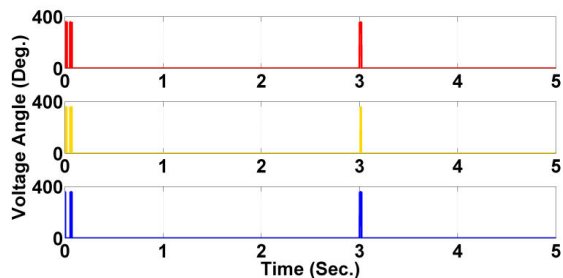

Fig. 3 (e)  $V_R, V_Y, V_B$  voltage phase angle during harmonic addition in input signal

From the case 1, If SLGF is generated at 0.5 second, the phase angle difference can be found in R-phase (Fig. 3 (b)) while Y and B phase angle difference remain same as Fig. 3 (a). Fig. 3 (c) shows the DLGF condition in which phase angle difference are observed in R and Y phase while B phase is not affected. During TLGF (Fig. 3 (d)), deviation of 0 to 360° is found in R and Y phase but in B phase 0 to 100° is observed which can be clearly seen. When harmonics are added at 3seconds (Fig. 3 (e)), the output voltage phase angle from the PMU remain same as positive sequence voltage and zero phase angle difference like (Fig. 3 (a)) can be obtained. Hence, from the above results, it is concluded that voltage phase angle output of the PMU is unaffected even if the input signal is full of harmonic.

2. Case-2

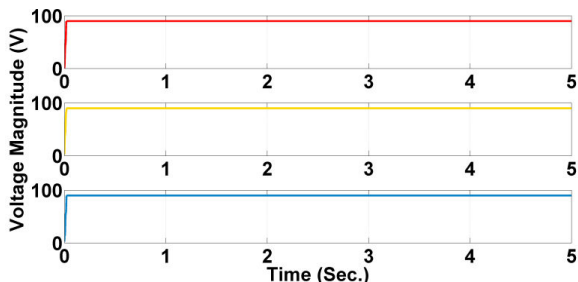

Fig. 4 (a)  $V_R, V_Y, V_B$  voltage magnitude during normal condition as a reference signal

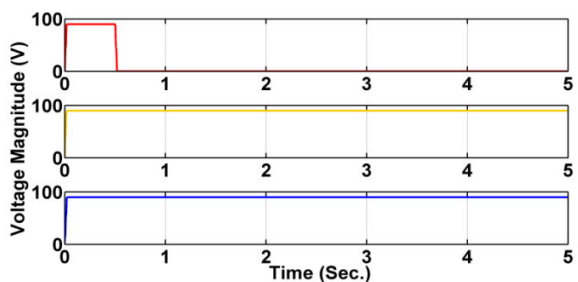

Fig. 4 (b)  $V_R, V_Y, V_B$  voltage magnitude during SLGF.

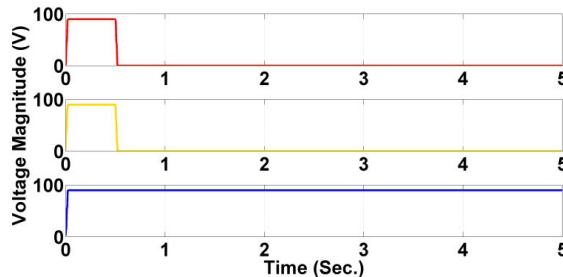

Fig. 4 (c)  $V_R, V_Y, V_B$  voltage magnitude during DLGF

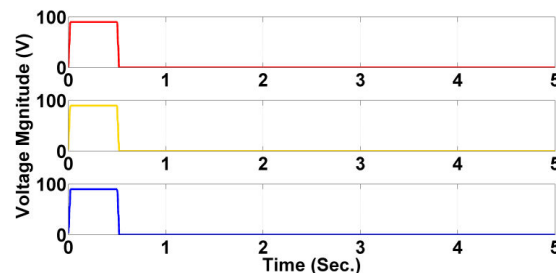

Fig. 4 (d)  $V_R, V_Y, V_B$  voltage magnitude during TLGF

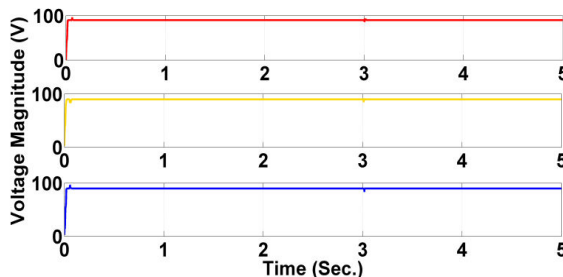

Fig. 4 (e)  $V_R, V_Y, V_B$  voltage magnitude during harmonic addition in input signal

The voltage magnitudes for various events have been shown in Figs. 4 (a)-(e). During SLGF, the voltage of that respective phase (R phase in Fig. 4 (b)) become zero at 0.5 second. The same result is obtained during DLGF (RYG) in Fig. 4 (c) and TLGF (RYBG) in Fig. 4 (d). Two dots indicating (all phases) harmonic injection at initial and at 3 second can be seen, but PMU output voltage magnitude is harmonic free (Fig. 4 (e)). In the above discussion, all the faults are created at 0.5 second and they are not cleared.

3. Case-3

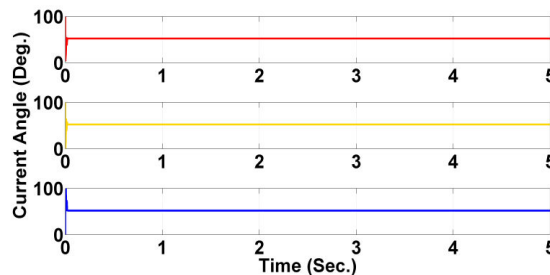

Fig. 5 (a)  $I_R, I_Y, I_B$  Current phase angle difference during normal condition as a reference signal

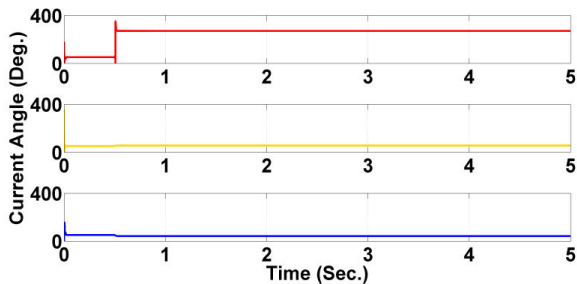

Fig. 5 (b)  $I_R, I_Y, I_B$  Current phase angle difference during SLGF

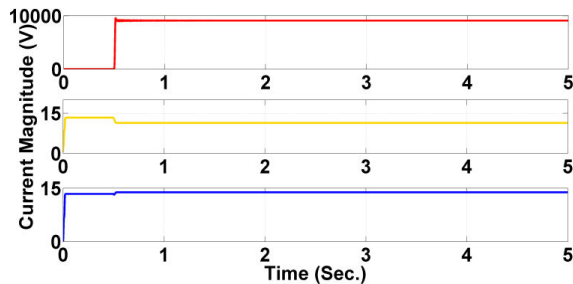

Fig. 6 (b)  $I_R, I_Y, I_B$  current magnitude during SLGF

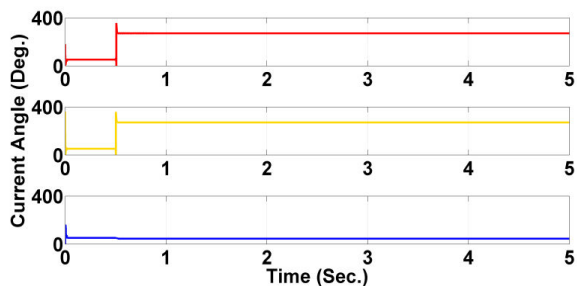

Fig. 5 (c)  $I_R, I_Y, I_B$  Current phase angle difference during DLGF

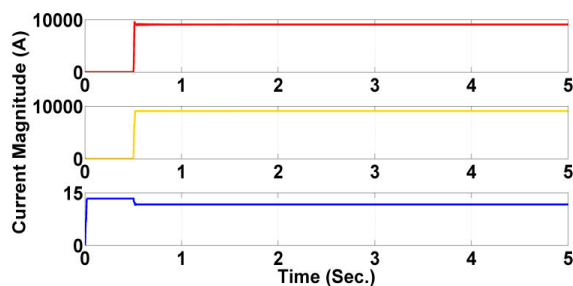

Fig. 6 (c)  $I_R, I_Y, I_B$  current magnitude during DLGF

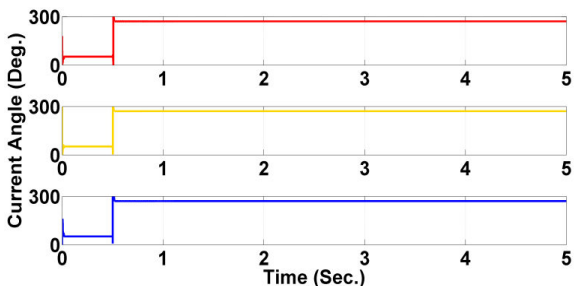

Fig. 5 (d)  $I_R, I_Y, I_B$  Current phase angle difference during TLGF

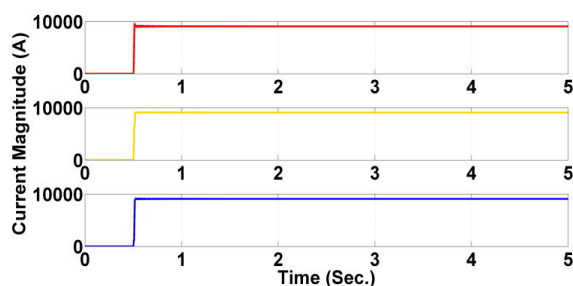

Fig. 6 (d)  $I_R, I_Y, I_B$  current magnitude during TLGF

From the case study 3, the effect of line to ground fault occurred at 0.5 second can be seen from Fig. 5 (b). Here, the phase angle of R phase varies from  $0^\circ$  to  $290^\circ$ . Similarly, the effect of DLGF in R and Y phase shown in Fig. 5 (c) and TLGF in R, Y and B phase is shown in Fig. 5 (d).

#### 4. Case- 4

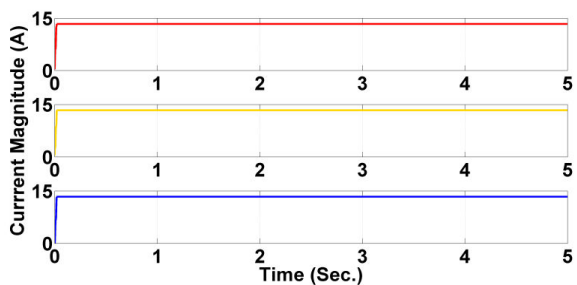

Fig. 6 (a)  $I_R, I_Y, I_B$  current magnitude during normal condition as a reference signal

In the case 4, the current magnitudes for different events are represented in Figs. 6 (a)-(d). Due to SLGF (Fig. 6 (b)), the current magnitude of R phase becomes thousands of ampere at fault time or at 0.5 second which can be seen. The same results are obtained during DLGF and TLGF which are shown in Figs. 6 (c) and (d) respectively.

#### VI. CONCLUSION

In this paper, PMU based simulated model with 11kv source is connected to 100kw load having a 50km long transmission line at 50Hz is presented and 30 samples per each cycle for voltage and current signals are taken. The test is carried out for healthy network as well as different fault condition like SLGF, DLGF and TLGF. After this test, voltage magnitude, current magnitude and their angles are compared with a reference signal. It is concluded that DFT based PMU model gives positive sequence and harmonic free fundamental output. The main purpose of this software is to explore the function of internal algorithm in the PMU performance under different contingencies. This simulation explores the concept implied in the phasor measurement unit for phasor estimation in wide area measurement system.



REFERENCES

- [1] Complex Quantities and their use in Electrical Engineering; Charles Proteus Steinmetz; Proceedings of the *International Electrical Congress, Chicago, IL; AIEE Proceedings*, 1893, pp 33-74.
- [2] Phadke, A. G.; "Synchronized phasor measurements-a historical overview," Transmission and Distribution Conference and Exhibition 2002: *Asia Pacific. IEEE/PES*, Vol. 1, no., pp. 476- 479 vol.1, 6-10 Oct. 2002.
- [3] R. Moxley, "Synchrophasors in the Real World," Schweitzer Engineering Laboratories, Inc. Available: <http://www.selinc.com/techpprs.html>.
- [4] Horowitz, S. H.; Phadke, A. G., "Boosting immunity to blackouts," *Power and Energy Magazine, IEEE* , Vol. 1, no. 5, pp. 47- 53, Sept.-Oct. 2003
- [5] Salehi, V.; Mazloomzadeh, A.; Fernandez, J. F.; Mohammed, O. A., "Real-time power system analysis and security monitoring by WAMPAC systems," *Innovative Smart Grid Technologies (ISGT), 2012 IEEE PES* , vol., no., pp.1-8, 16-20 Jan. 2012.
- [6] A New Measurement Technique for Tracking Voltage Phasor, Local System Frequency, and Rate of Change of Frequency; A. Phadke, J. Thorp, M. Adamiak; *IEEE Trans.* vol. PAS-102 no. 5, May 1983, pp 1025-1038.
- [7] De La Ree, J., Centeno, V., Thorp, J. S., Phadke, A.G.: Synchronized phasor measurement applications in power systems. *IEEE Trans. Smart Grid 1(1)*, pp 20–27, 2010.
- [8] Mahmoud M, Amin, Heba B. Moussa, Osama A. Mohammed: Wide area measurement system for smart grid application involving hybrid energy sources. *Springer verlat 2012 Energy System*, pp 3-21.
- [9] Metke, A. R., Ekl, R. L.: Security technology for smart grid networks. *IEEE Trans. Smart Grid 1(1)*, 99–107, 2010.
- [10] Pipattanasomporn, M., Feroze, H., Rahman, S.: Multi-agent systems in a distributed smart grid: design and implementation. In: *IEEE PES 2009 Power Systems Conference and Exposition (PSCE'09), Seattle, USA 2009*.
- [11] Krishna, R. V.; Ashok, S.; Krishnan, M. G., "Synchronised Phasor Measurement Unit" *Power Signals Control and Computations (EPCICON)*, 2014 International Conference on, vol., no., pp.1,6,6-11 Jan. 2014.
- [12] M. Zima, T. Krause and G. Andersson, "Evaluation of System Protection Schemes, Wide Area Monitoring and Control Systems," 2002.
- [13] Phadke, A. G., "Synchronized phasor measurements-a historical overview," Transmission and Distribution Conference and Exhibition 2002: *Asia Pacific. IEEE/PES*, vol.1, no., pp.476, 479 vol.1, 6-10 Oct. 2002.
- [14] "IEEE Standard for Synchrophasors for Power Systems", C37.118-2005. Sponsored by the Power System Relaying Committee of the Power Engineering Society, pp 56–57.
- [15] IEEE Draft Standard for Synchrophasor Measurements for Power Systems, *IEEE C37.118.1*, 2011.
- [16] Wang Bo; Dai Ze Mei; Lu Jin Jun; Zheng Tao; Shan Xin; Liu Dong, "The visualization design and realization of wide area measurement system," *Innovative Smart Grid Technologies - Asia (ISGT Asia)*, 2012 IEEE , vol., no., pp.1,6, 21-24 May 2012.
- [17] Heydt G. T., Lie C. C., Phadke A. G., and Vital V., "Solutions for the crisis in electric power supply," *IEEE Comput. Appl. Power Mag.*, vol.14, no. 3, pp. 22–30, 2001.
- [18] Zhao L., and Abur A., "Multiarea State Estimation Using Synchronized Phasor Measurements", *IEEE Trans on Power Systems*, Vol. 20, No. 2, pp. 456-462, 2005.
- [19] Aminifar, F.; Shahidehpour, M.; Fotuhi-Firuzabad, M.; Kamalinia, S., "Power System Dynamic State Estimation with Synchronized Phasor measurements," *Instrumentation and Measurement, IEEE Transactions on*, vol.63, no.2, pp.352, 363, Feb. 2014.
- [20] Jiang J. A., Lin Y. H., Yang J. Z., Too T. M, and Liu C. W., "An Adaptive PMU Based Fault Detection/Location Technique for Transmission Lines—Part II: PMU Implementation and Performance Evaluation," *IEEE Trans. On Power Delivery*, Vol. 15, No. 4, pp 486-493, 2000.
- [21] Tate J. E., and Overbye T. J., "Line Outage Detection Using Phasor Angle Measurements," *IEEE Trans. On Power Systems*, Vol. 23, No. 4, pp. 1644-1652, 2008.
- [22] Jizhong Zhu; Hwang, D.; Sadjadpour, A., "Real Time Congestion Monitoring and Management of Power Systems," Transmission and Distribution Conference and Exhibition: *Asia and Pacific, 2005 IEEE/PES*, vol., no., pp.1-5, 2005.
- [23] Xiying Chen; Weixing Li; He Chen; Zhizhong Guo; "Research of Out-of-Step Protection System Based on Wide Area Measure System," *Power System Technology*, 2006. Power Con 2006. International Conference on Vol., no., pp.1-5, 22-26 Oct. 2006.
- [24] Salehi-Dobakhshari, A.; Ranjbar, A. M., "Application of synchronised phasor measurements to wide-area fault diagnosis and location," *Generation, Transmission & Distribution, IET*, vol.8, no.4, pp.716, 729, April 2014.
- [25] Chao Zhang; Zhiqian Bo; Baohui Zhang; Klimek, A.; Min Han; Jiancheng Tan, "An integrated PMU and protection scheme for power systems," *Universities Power Engineering Conference (UPEC)*, 2009 Proceedings of the 44th International, vol., no., pp.1-4, 1-4 Sept. 2009.
- [26] Prabha Kundur: "*Power System Stability and Control*", McGraw- Hill, Inc, 1994.
- [27] V. Balamourougan, T. S. Sidhu, and M. S. Sachdev, "Technique for online prediction of voltage collapse," *IEEE Proc. C*, vol. 151, pp.453–460, 2004.
- [28] Younis, M.R.; Irvani, R., "Wide-area damping control for inter-area oscillations: A comprehensive review," *Electrical Power & Energy Conference (EPEC)*, 2013 IEEE, vol., no., pp.1, 6, 21-23 Aug. 2013.
- [29] A.G. Phadke and J.S. Thorp, *Synchronized Phasor Measurements and their Applications*, Springer, 2008.
- [30] Karimi-Ghartemani, M.; Boon-Teck Ooi; Bakhshai, A., "Investigation of dft-based phasor measurement algorithm," *Power and Energy Society General Meeting*, 2010 IEEE , vol., no., pp.1,6, 25-29 July 2010.