

Haemodynamics Study in Subject Specific Carotid Bifurcation Using FSI

S. M. Abdul Khader, Anurag Ayachit, Raghuvir Pai, K. A. Ahmed, V. R. K. Rao, S. Ganesh Kamath

Abstract—The numerical simulation has made tremendous advances in investigating the blood flow phenomenon through elastic arteries. Such study can be useful in demonstrating the disease progression and hemodynamics of cardiovascular diseases such as atherosclerosis. In the present study, patient specific case diagnosed with partially stenosed complete right ICA and normal left carotid bifurcation without any atherosclerotic plaque formation is considered. 3D patient specific carotid bifurcation model is generated based on CT scan data using MIMICS-4.0 and numerical analysis is performed using FSI solver in ANSYS-14.5. The blood flow is assumed to be incompressible, homogenous and Newtonian, while the artery wall is assumed to be linearly elastic. The two-way sequentially coupled transient FSI analysis is performed using FSI solver for three pulse cycles. The hemodynamic parameters such as flow pattern, Wall Shear Stress, pressure contours and arterial wall deformation are studied at the bifurcation and critical zones such as stenosis. The variation in flow behavior is studied throughout the pulse cycle. Also, the simulation results reveal that there is a considerable increase in the flow behavior in stenosed carotid in contrast to the normal carotid bifurcation system. The investigation also demonstrates the disturbed flow pattern especially at the bifurcation and stenosed zone elevating the hemodynamics, particularly during peak systole and later part of the pulse cycle. The results obtained agree well with the clinical observation and demonstrates the potential of patient specific numerical studies in prognosis of disease progression and plaque rupture.

Keywords—Fluid-Structure Interaction, arterial stenosis, Wall Shear Stress, Carotid Artery Bifurcation.

I. INTRODUCTION

THE advancements in numerical simulation in recent years has led to aid the investigation of cardiovascular diseases. These studies shall be helpful to clinicians or physiologists to understand the mechanical environments in normal and diseased arteries or diseased organs. Especially, the flow in regions, such as bifurcation or arterial curvature is quite complex and more prone to development of atherosclerosis/

Dr. S. M. Abdul Khader and Dr. Raghuvir Pai. B are with the Mechanical Engineering Department, Manipal Institute of Technology, Manipal University, Manipal – 576104, India. (Phone: +91-0820-2925465; e-mail: smak.quadri@gmail.com, raghuvir.pai@gmail.com).

Dr. Anurag Ayachit is with the Radio-diagnosis and Imaging Department, Kasturba Hospital, Manipal University, Manipal – 576104, India (Phone: +91-0820-2925465; e-mail: ayachit@gmail.com).

Dr. Kamarul Arifin bin Ahmed is with the Aerospace Engineering Department, Universiti Putra Malaysia, Selangor – 43499, Malaysia. (Phone: +006- 03-8946405; e-mail: aekamarul@eng.upm.edu.my).

Dr. V.R.K. Rao is Clinical Director- Radiology, KIMS, Secunderabad, India (e-mail: vedula@gmail.com).

Dr. Ganesh Kamath is with the Cardio Vascular and Thoracic Surgery Department, Kasturba Medical College, Manipal University, Manipal – 576104, India. (Phone: +91-0820-2922313; e-mail: sevagur@hotmail.com).

constriction [1]. The flow behavior through normal and healthy artery is quite different in contrast to the stenosed artery with elevated stresses and high resistance to flow. The study of such important physiological simulation of flow through stenosis has profound implications for the diagnosis and treatment of vascular disease [3], [4]. Investigating the realistic physiological blood flow phenomenon accurately can be achieved through complex interaction of flexible arterial wall with the blood flow using coupled field analysis such Fluid Structure Interaction (FSI).

Several past flexible and rigid wall studies have considered both the idealistic and patient specific geometry models based on *in-vivo* data. The flow in idealistic stenosis had been of much interest as it provided the nature of flow behavior demonstrating the highly complex flow in the down-stream side of stenosis [5], [6]. Further, pulsatile flow through stenosed elastic artery was also investigation and it was reported that intense increase in the pressure drop and wall shear stress are associated with the flow and increased stenosis severity. The flow resistance in arteries increases abruptly due to the influence of high grade stenosis [7], [8]. Also, the constriction and high blood pressure causes high flow velocity, high wall shear stress and low pressure at the throat of the stenosis, while in the distal side of stenosis, there will be low wall shear stress, flow separation and wall compression. However, the much required observation of flow behavior in critical areas such as bifurcation, carotid bulb, flow separation or turbulence in realistic anatomical models is possible only through subject specific flow simulation [9]. A reliable flow simulation requires the realistic 3D vascular geometric model and unsteady flow boundary conditions.

There are several studies which have investigated the importance of 3D realistic geometry and different techniques of actual model generation. The geometry data is obtained through *in-vivo* measurements such as MRI slides, ultrasound and angiogram data such as CT, DSA and x-ray [10], [11]. There was good agreement in the results obtained between the numerical simulation results and both phantom and *in-vivo* experiments. Thus, the resulting hemodynamic observation can be compared with the *in-vivo* data and used to assess the health risk, of occlusion, embolism, or plaque rupture, posed by a particular plaque deposit [12]. Hence, in the present study hemodynamics is studied in subject specific model considering a case study of patient diagnosed with partial narrowing of complete right Internal Carotid Artery and normal left carotid bifurcation. The numerical investigated is carried out considering two-way sequentially coupled transient FSI analysis focusing on flow parameters like velocity, wall

shear stress, pressure profile, arterial wall deformation and von-Mises stresses in detail. Thus, these observations are beneficial in predicting the outcome of severity of stenosis and help the medical fraternity in detailed understanding of flow behavior across stenosis and its progression.

II. METHODOLOGY

The blood flow behavior in common carotid artery is assumed to be governed by the Navier–Stokes equations of incompressible flows. The fluid domain in FSI simulation is solved using modified momentum equation adopting moving velocity along with continuity equation as given in (1) [2], [11], [12]:

$$\frac{\partial}{\partial t} \int_{\Omega} \rho \delta \Omega + \int_S \rho (v - v_b) \cdot n \delta S = \int_S (\tau_{ij} i_j - P i_i) \cdot n \delta S + \int_{\Omega} b_i \delta \Omega \quad (1)$$

where ρ is the density, τ is the stress tensor, v is the velocity vector, v_b is the grid velocity, P is the pressure, b_i is the body force at time t .

The artery wall is assumed to be elastic, isotropic, incompressible and homogeneous and the transient dynamic structural solution is given by (2) [4]. The stiffness matrix is updated in each time step and the Newmark method is adopted in updating the displacement terms at each time interval and further the stiffness matrix is solved using direct solver in particular sparse solver for each time step.

$$[M]\{\ddot{U}\} + [C]\{\dot{U}\} + [K]\{U\} = \{F^a\} \quad (2)$$

where M is the structural mass matrix, C is the structural damping matrix, K is structural stiffness matrix, F^a is the applied load vector and \ddot{U} , \dot{U} and U represent acceleration, velocity and displacement vector respectively.

The two-way sequentially coupled transient FSI analysis is performed using FSI solver in ANSYS 14.0. FSI solver solves fluid and solid domain separately using ANSYS CFX and ANSYS MECHANICAL respectively as shown in Fig. 1. The pressure loads from initial ANSYS CFX solution is transferred to the solid domain through FSI interface and later ANSYS structural domain is solved. Further details of FSI solver are described in detail as observed in [2], [13].

In the present study, a case study of old patient is taken up whose left carotid system is normal and right Common Carotid Artery (CCA) is also normal with partial narrowing of approximately 60% of the entire segment of Internal Carotid Artery (ICA). However, external carotid artery (ECA) in both the carotids appears to be normal. The partially stenosed right ICA is highlighted in three different views as shown in Fig. 2 (a), and similarly the normal left carotid bifurcation is shown in Fig. 2 (b). The 3D fluid and solid surface models of normal and stenosed carotid bifurcation system aneurysm are generated using MIMICS-14 based on CT angio data. The solid model is generated using CATIAV5R20.0, versatile geometric modeling software and further transferred to ANSYS 14.0 for the meshing.

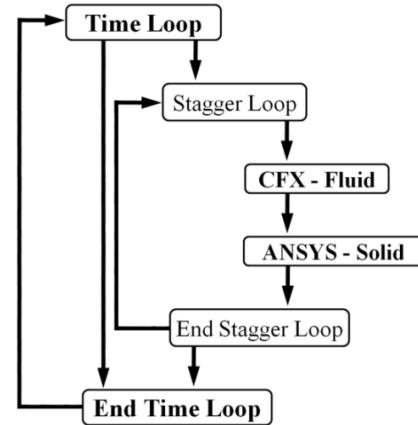

Fig. 1 FSI algorithm

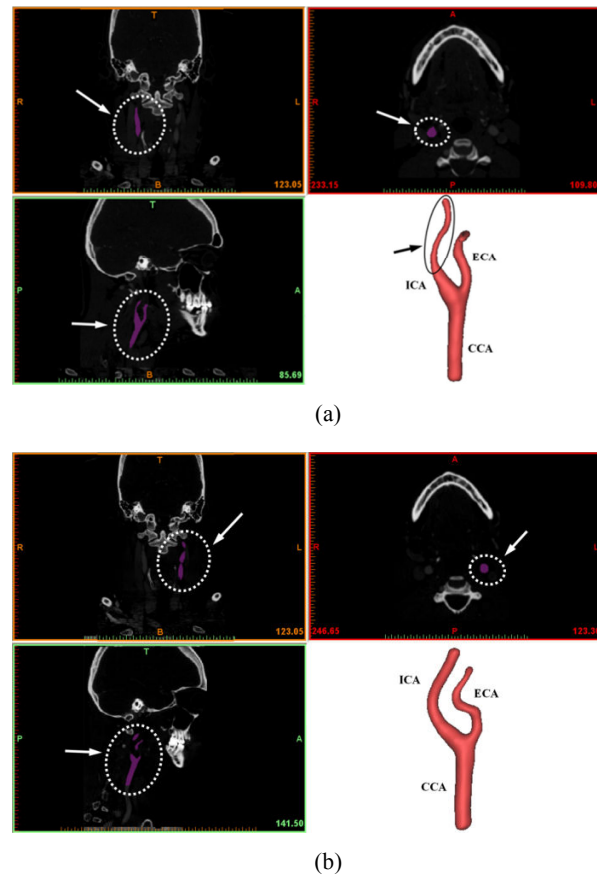

Fig. 2 Different views of CT scan of case-2 carotid bifurcation, (a) Right carotid– partial ICA stenosis and (b) Left carotid – normal

The normal carotid fluid and solid models are meshed with 35,000 and 28,000 hexahedral elements respectively as shown in Fig. 3. Similarly, stenosed carotid bifurcation solid and fluid models are discretized into 33420 and 26820 hexahedral elements as shown in Fig. 3. In the present study, time varying velocity pulse is applied at inlet of both normal and stenosed carotid system based on patient specific Ultrasound Duplex scan as shown in Fig. 4. To include the peripheral resistance, a time varying pressure wave form is applied at the outlet as shown in Fig. 4 [5]. Each pulse cycle for a time period of 0.8 s

is discretized into 180 time steps to simulate the flow behavior more accurately. The inlet and outlet of both the normal and stenosed carotid solid models are constrained by specifying zero-displacement in all the directions and rest of the nodes are left free to undergo displacement in any direction [14], [15].

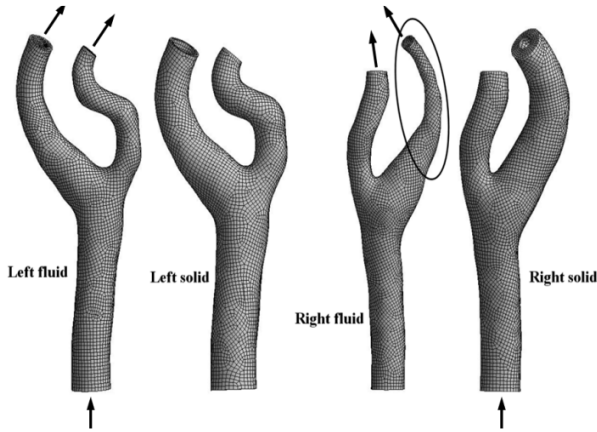

Fig. 3 FSI carotid bifurcation model

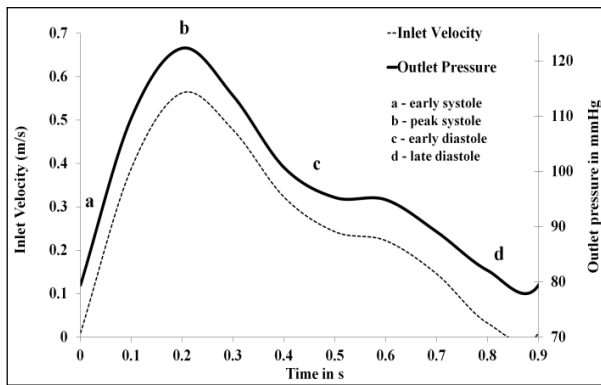

Fig. 4 Flow boundary conditions

Even though blood flow is non-Newtonian physiologically, however in the present study, since the focus is on large arteries, Newtonian assumption is acceptable as relatively high shear rate occurs. In medium and smaller arteries, non-Newtonian assumption is valid as shear rate is lower than $100s^{-1}$ and shear stresses depend non-linearly on the deformation rate. The density and dynamic viscosity of the blood is considered to be $1050 kg/m^3$ and $0.004N\text{-sec}/m^2$ respectively [15].

The arterial wall is assumed to behave linearly-elastic with density of $1120 kg/m^3$, Poisson's ratio of 0.40 and elastic modulus is 0.9 MPa [10], [15]. The convergence criteria of fluid flow and across the fluid-surface interface is set at 10^{-4} and 10^{-3} respectively and low Reynolds $k-\omega$ model is used to model the turbulence behavior [8]. These simulation results provide useful data in quantifying the hemodynamic changes to medical fraternity in understanding the clinical cases indicating the potential of atherosclerotic progression and rupture.

III. RESULTS AND DISCUSSION

The simulation of both the carotids is carried out for 3 pulse cycle and results in the last cycle is considered for the investigation. The hemodynamics parameters like velocity, wall shear stress, pressure, arterial wall deformation and von-Mises stress are studied at specific instants of pulse cycle like early systole, peak systole, early diastole and late diastole. WSS, von-Mises stress are considered to be the most crucial and interesting hemodynamic parameters related to the atherosclerotic progression. It varies with time due to the pulsatility of the flow waveform and the maximum value generally occurs at the peak systole when the inflow is maximum.

The velocity streamlines contours of stenosed and normal carotid at peak systole is compared as shown in Fig. 5. The partial narrowing of concentric nature in right ICA has substantially increased the velocity at the stenosed region. The flow pattern in right side stenosed carotid bifurcation is moderately altered in comparison with the left side normal carotid bifurcation; whereas, similar flow pattern is demonstrated in CCA of both the carotids [10].

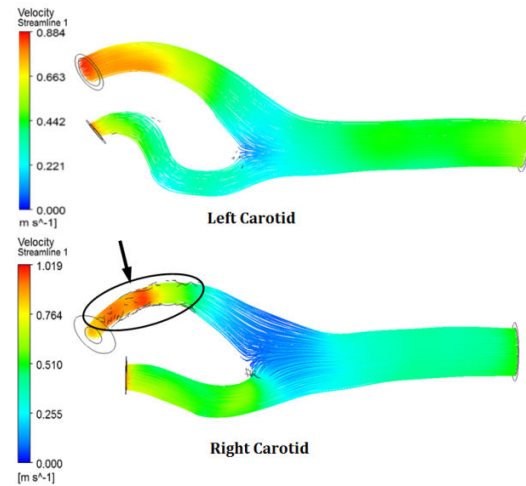

Fig. 5 Comparison of velocity contours

Flow separation can be clearly observed at the bifurcation region, especially at the carotid bulb oriented towards ICA root of both the carotids. The flow separation zone extends to longer range towards distal part of stenosed ICA due to partial narrowing when compared with normal ICA [3]. The normal carotid bifurcation shows the typical flow distribution at the bifurcation tip with higher flow rate in ICA than in ECA. The stenosed right ICA restricts the flow moderately and partially diverts the remaining flow towards left ECA [5]. The right stenosed carotid bifurcation has higher velocity range in comparison with the left normal carotid (Fig. 5).

WSS contours of stenosed and right carotid system is compared as shown in Fig. 6 at peak systole. Even though the left carotid appears to be normal; but, WSS profile is quite distinct unlike typical WSS pattern in carotid bifurcation, because of the extremely tortuous ECA and ICA. The WSS is moderately higher in CCA, drops drastically at the bifurcation

region, and increases again at inner wall of ECA and ICA at distal end [18]. However, in stenosed carotid system, due to partial narrowing of complete ICA till distal end, the WSS behavior is highly altered, particularly in the bifurcation region [16]. At this location, flow separation is found to be quite intense, resulting in significantly low WSS, covering larger area in CCA and ICA [19]. Also, there is significant rise in WSS, near the apex towards the inner wall of ECA, and maximum at stenosed region in right ICA. The highly disturbed flow in the right carotid bifurcation will increase the vortex formation and further induce the atherosclerotic damage to arterial wall.

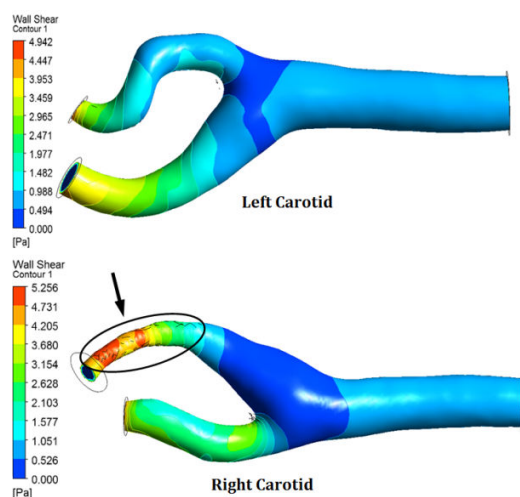

Fig. 6 Comparison of wall shear stress contours

The right carotid has higher deviation in WSS when compared with the left carotid system (Fig. 7). The shear stress is distributed to larger area occupied by ICA and at bifurcation zone, thus stimulating the aggravation of atherosclerosis and inducing endothelial dysfunction [19]. Also, the higher wall shear stress at the maximum stenosed region, especially during head down position will increase the platelet aggregation and accelerating the plaque formation and increasing the risk of thrombosis [10].

The pressure contours at peak systole in stenosed and normal carotid bifurcation are compared in Fig. 7. The pressure distribution pattern shows significant changes in both the carotids [20]. The flow restriction in right ICA has elevated the pressure at the bifurcation apex extending it up to the proximal location of narrowing [10]. It also influences in elevating the pressure in CCA proximal to bifurcation region. This increased pressure profile exists till the mid diastole due to the flow restriction, while the normal left carotid bifurcation demonstrates a typical pressure profile with the maximum pressure at the bifurcation tip [19]. The left ECA is severely tortuous influencing the pressure rise when compared with right ECA, which has smaller curvature.

The arterial wall deformation distribution of normal and stenosed carotid is shown in Fig. 8. The maximum wall deformation is found to be at the bifurcation region in both the carotids, similar to that of normal carotid bifurcation

throughout the pulse cycle. However, the variation in deformation magnitude varies due to the difference in the lumen diameter, severity of tortuous in region of bifurcation zone, ICA and ECA.

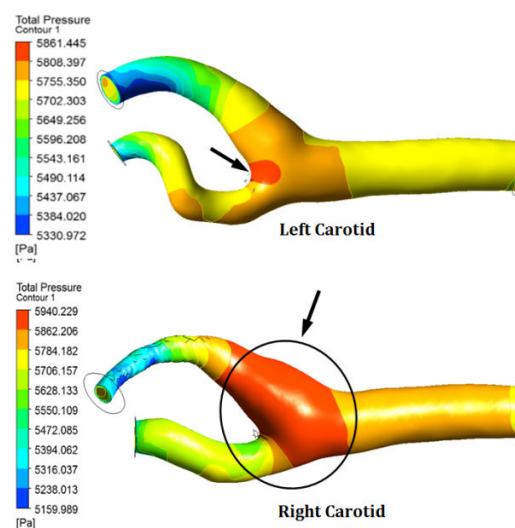

Fig. 7 Comparison of pressure contours

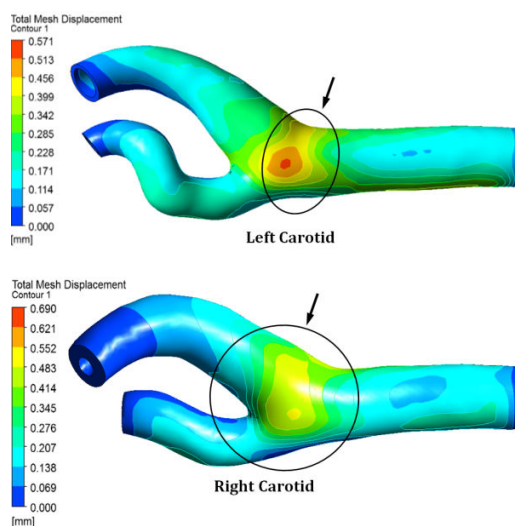

Fig. 8 Comparison of arterial wall displacement contours

The concentric mild stenosis till the distal end of right ICA has influenced the increase in stiffness of the artery and further resulted in reduced deformation at the stenosed region, as observed from Fig. 8 [14]. However, the increased pressure proximal to the entrance of stenosis considerably increases the wall displacement [17]. When compared with stenosed carotid, there are no traces of arterial wall stiffening, and wall deformation is observed in the entire branch of ICA in normal carotid [18]. When flow decelerates during end diastole, the turbulence in bifurcation region and carotid bulb aggravates, resulting in pressure drop and reduced wall deformation.

The von-Mises stress distribution is shown in Fig. 9 at peak systole in both the carotids [1]. The maximum stress is located at the bifurcation zone in both carotid systems [7]. Due to

partial narrowing of entire right ICA, the entire stretch of stenosis is influenced by very low stress and subjected to compression when compared with the left carotid [10]. The steep stress gradient in right carotid is more significant unlike to that observed in left carotid system [18]. The combination of low pressure, high wall shear stress and compressive von Mises stress influences the atherosclerotic progression and even lead to rupture.

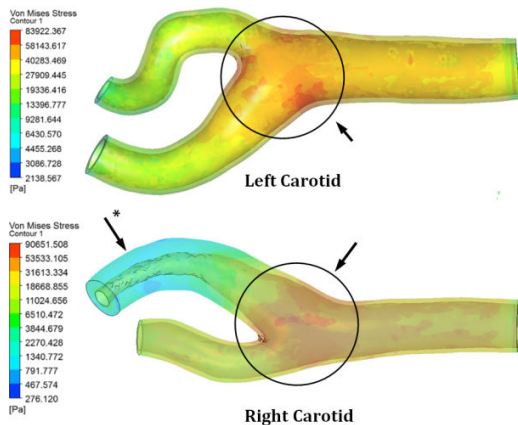

Fig. 9 Comparison of von Mises stress contours

The stress concentration factor is 2.2 and 3.75 in the apex region of left and right carotid respectively. The presence of partial narrowing has influenced the increased pressure in upstream which is related to rise in von Mises stress considerably. Hence, the stress pattern is more distributed and stretched in right CCA when compared with the left carotid bifurcation. Therefore, the present investigation can simulate the risk or prognosis of arterial disease and it cannot be neglected as it has profound influence on the altering the flow dynamics, WSS distribution, stress levels and wall deformation.

IV. CONCLUSIONS

The present case simulated using FSI is a combination of normal and partially stenosed carotid bifurcation. The right ICA is partially narrowed, while the rest of the carotid system is diagnosed to be normal. The flow restriction offered by the partial stenosis has considerably affected the flow in downstream side. However, due to mild narrowing (less than 70%), clinically it is termed to be less significant with low risk factor. From the present investigation, significantly variation is observed in right carotid in contrast to the left carotid system. The partial narrowing has reduced the arterial wall stiffness (due to increased pressure) and increased the arterial wall deformation. The increased WSS in the region of maximum stenosis has the large risk of atherosclerotic plaque rupture. The low wall shear stress at the bifurcation is found to be more in right carotid than the left carotid highlighting the region is prone to atherosclerosis progression. The large variation in pressure in turn increases the wall deformation, which affects the stiffness of the arterial wall. The arterial wall becomes stiffer with the increased severity of stenosis. Severe

stenosis will increase the pressure and in turn increasing the arterial wall stiffness. The risk factor associated is quite high in the right carotid than the left carotid system.

REFERENCES

- [1] M. Bathe, R. Kamm, "A Fluid Structure Interaction finite element analysis of pulsatile blood flow through a compliant stenotic artery", *Journal of Biomechanical Engineering Transactions of the ASME*, vol. 121, pp.361-369, 1999.
- [2] R. Torii, M. Oshima, T. Kobayashi, K. Takagi and T.E. Tezduyar, "Fluid-Structure Interaction modeling of aneurismal conditions with high and normal blood pressures", *Computational Mechanics*, vol.38, pp.482-490, 2006.
- [3] Ku, D.N., "Blood Flow in Arteries", *Annual Review of Fluid Mechanics*, 29 (1), 399-434, 1999.
- [4] Q. Long, X. Xu, "Numerical Investigations of physiological pulsatile flow through arterial stenosis", *Journal of Biomechanics*, vol. 34, pp.1229-1242, 2001.
- [5] Deshpande, M.D., Vinay Ballal, Shankapal, S.R., Vinay, M.D. Prabhu and Srinath, M.G., "Subject specific blood flow simulation in the human carotid artery bifurcation", *Current Science*, 97 (9), 1303-1312, 2009.
- [6] K. Perktold, G. Rappitsch, "Computer simulation of local blood flow and vessel mechanics in a compliant carotid artery bifurcation model", *Journal of Biomechanics*, vol. 25, pp.845-856, 1995.
- [7] D. Tang, C. Yang, "Wall stress and strain analysis using a 3D thick-wall model with fluid-structure interactions for blood flow in carotid arteries with stenosis", *Computers and Structures*, vol. 72, pp.341-356, 1999.
- [8] Oh, T.S., Ko, Y.B., Park, S., Yoon, K., Lee, "Computational Flow Dynamics Study in Severe Carotid Bulb Stenosis with Ulceration", *Neurointervention*, vol. 5, pp. 97-102, 2010.
- [9] Marshall, I., Zhao, S., Papathanasopoulou, P., Hoskins, P., and Xu, Y., "MRI and CFD studies of pulsatile flow in healthy and stenosed carotid bifurcation models", *Journal of Biomechanics*, 37 (5), 679-687, 2004.
- [10] Lee, S.H., Kang, S., Hur, N., and Jeong, S.K., "A fluid-structure interaction analysis on hemodynamics in carotid artery based on patient-specific clinical data", *Journal of Mechanical Science and Technology*, 26 (12), 3821-3831, 2013.
- [11] J. Ferziger, M. Peric, "Computational Methods for Fluid Dynamics", Berlin Heidelberg, 2002.
- [12] Y. Fung, "Biodynamics-Circulation", Springer Verlag, New York Inc, 1984.
- [13] ANSYS Release 14.0 Documentation (2012), ANSYS Company, Pittsburgh, PA.
- [14] S. Zhao, X. Xu, M. Collins, "Blood flow and vessel mechanics in physiological realistic model of a human carotid arterial bifurcation", *Journal of Biomechanics*, vol. 32, pp.975-984, 2000.
- [15] C.A. Figueroa, I.E. Vignon-Clementel, K.C. Jansen, T.J.R. Hughes, C.A. Taylor, "A Coupled Momentum Method for Modelling Blood Flow in Three-Dimensional Deformable Arteries," *Computer Methods in Applied Mechanics and Engineering*, vol. 195, (41-43), pp. 5685-5706, 2006
- [16] Valencia, A. and Villanueva, M, "Unsteady flow and mass transfer in models of stenotic arteries considering fluid-structure interaction", *International Communications in Heat and Mass Transfer*, vol.33 (8), pp.966-975, 2006.
- [17] Tada, S. and Tarbell, J.M, "A computational study of flow in a compliant carotid bifurcation-stress phase angle correlation with shear stress", *Annals of Biomedical Engineering*, vol. 33(9), pp. 1202-1212, 2005.
- [18] Younis, H.F., Kaazempur-Mofrad, M.R., Chan, R.C., and Isasi, A G., "Hemodynamics and wall mechanics in human carotid bifurcation and its consequences for atherogenesis: investigation of inter-individual variation", *Biomechanics and Modeling in Mechanobiology*, 3 (1), 17-32, 2004.
- [19] Lee, S.H., Choi, H.G., and Yool, J.Y., "Finite element simulation of blood flow in a flexible carotid artery bifurcation", *Journal of Mechanical Science and Technology*, 26 (5), 1355-1361, 2012.
- [20] Li, Z. Y., Taviani, V., Tang, T., Sadat, U., Young, V., Patterson, Graves, M., and Gillard, J.H., "The mechanical triggers of plaque rupture: shear stress vs pressure gradient", *The British Journal of Radiology*, 82, S39-45, 2009.

Dr. S. M. Abdul Khader was born in Bhadravathi in the year 1983 on 5th August. He has graduated in Mechanical Engineering in 2005 from Visweswariah Technological University, Karnataka. He completed his Masters Degree in Computer Aided Mechanical Design and Analysis in 2007. He joined Manipal Institute of Technology, Manipal as Lecturer in Department of Mechanical and Manufacturing Engineering in 2007 and recently finished his PhD in the area of Fluid-Structure Interaction. His areas of interest are Fluid-Structure Interaction, Computational Bio-fluid Mechanics, CFD, Structural Analysis and Machine Design.

Dr. Anurag Ayachit was born and brought up in Dehradun. He finished his graduated in Medicine in the year 2002 from Ganesh Shankar Memorial Medical College (GSVM), Kanpur. He completed his M.D in Radiodiagnosis in 2007 from Himalayan Institute of Medical Sciences, Dehradun.

Dr. Ayachit is presently working as Associate Professor in Department of Radio-Diagnosis and Imaging, Kasturba Hospital, Manipal University. His core expertise is in the domain of Advanced Ultrasound Imaging, Advanced CT applications such as CT Enteroclysis, Virtual Endoscopy, Perfusion imaging and Cardiac imaging, Advanced MR imaging and Diagnostic and Therapeutic Interventional Radiology. He has been the University topper during his PG entrance examination. He has recent publication in the area of numerical analysis of blood flow to his credit.

Dr. Raghuvir Pai. B born in Ballambat on 26/03/1964 had his Bachelors in Mechanical Engineering in 1982 from the University of Mysore. In 1988, he went to the Indian Institute of Technology, Kharagpur and completed his Doctoral degree in Tribology. From February 1995 to February 1996, he had worked as a Department of Science and Technology (Government of India), BOYSCAST Postdoctoral research fellow at Cranfield University, England.

He has research and teaching experience of 2 years (2000-2002) at Queensland University of Technology, Brisbane, Australia. Dr. Pai has published more than 100 research papers in Journals, International and National conferences. He has supervised 04 Ph.D. students in the area of Tribology Water Lubricated Bearings, Externally adjustable bearings and Tri-taper bearings and Tribology of machining metal matrix composites. He was a principal investigator for research projects by Philips, Bharat Heavy Electricals and GE JFWTC Global Research Centre, Bangalore. He has conducted more than 10 short courses in the field of Tribology. Currently he is the Director-Research (Technical) in Manipal University, Manipal.

Dr. V.R.K. Rao was born in Anakapalle on 13th July 1948. He obtained his M.B.B.S degree in 1970 from Andhra University, post-graduate in D.M.R.D from Delhi University in 1974 and M.D. Radiology in 1977 from Banaras Hindu University. He has research and teaching experience of thirty one years in field of Diagnostic and Interventional Radiology. He started his career as Asst. Prof. in Shree Chitra Tirunal Institute for Medical Sciences and Technology, Thiruvanthapuram from 1977-1982, Associate Prof. from 1982-1987 and Prof. and Head from 1987-1993. Later he moved to Al-Jazeera and Central Hospitals, Abu Dhabi as Head of Radiology Department and worked there till 2005. He had his short stay as Head of Radiology Department in Kerala Institute of Medical Sciences, Thiruvanthapuram till 2006 and shifted to Kasturba Hospital, Manipal as the Head of Radiology and Diagnostic Imaging till July 2013. Currently he is the Clinical Director, KIMS, Secunderabad, India.

Dr. Rao has over 88 publications to his credit and has presented more than 110 lectures at various conferences and seminars. He is a member of various National and International associations in field of Neurology, Neuroradiology and Interventional Radiology and has many awards and Honours to his credit. His research areas are development of suitable embolic agents for endovascular treatment, Radiology Information and Management Systems and Development of endovascular prostheses.

Dr. S. Ganesh Kamath was born in 07/07/1960 and finished his under graduation in Medicine in 1984 in Kasturba Medical College, Mangalore. From the same institute, he completed his post-graduation in General Surgery (M.S.) in 1989. He secured the post-doctoral degree of MCh in Cardiovascular Thoracic Surgery in 1992 from Kasturba Medical College, Manipal.

He is the Head of Department of Cardio-Vascular and Thoracic Surgery in KMC, Manipal from 2002 onwards and has 17yrs of experience of Post MCh teaching experience. 2