

# Towards an E-Learning Platform Multi-Agent Based On the E-Tutoring for Collaborative Work

Badr Hssina, Belaid Bouikhalene, Abdelkrim Merbouha

**Abstract**—This article presents our prototype MASET (Multi Agents System for E-Tutoring Learners engaged in online collaborative work). MASET that we propose is a system which basically aims to help tutors in monitoring the collaborative work of students and their various interactions. The evaluation of such interactions by the tutor is based on the results provided by the automatic analysis of the interaction indicators. This system is predicated upon the middleware JADE (Java Agent Development Framework) and e-learning Moodle platform. The MASET environment is modeled by AUML which allows structuring the different interactions between agents for the fulfillment and performance of online collaborative work. This multi-agent system has been the subject of a practical experimentation based on the interactions data between Master Computer Engineering and System students.

**Keywords**—AUML, Collaborative work, E-learning, E-tutoring, JADE, Moodle, SMA, Web Agent.

## I. INTRODUCTION

TEACHERS are always looking for different ways to increase the quality of their teaching. Currently, the use of computers and new technologies has become an important aspect of education. They allow the teaching community to redefine some of the strategies and teaching-learning concepts. For these reasons, e-learning [1] has largely become an indispensable teaching tool in universities.

Today, e-learning platforms have become increasingly complex, the fact which has made the task of monitoring and e-tutoring learners become more challenging. This work tries henceforth to facilitate e-tutoring [3]-[10] in new and different ways. The objective is to foster collaborative work on an e-learning platform.

Despite the many services offered by the platform LMS (Learning Management System), tutors still find it difficult to control and keep a close eye on their students' work [11]. The tutor has in the middle of all this to understand, decipher and reconstruct the learners' activities without having ample data. This task of reconstruction is tedious but yet mandatory as it allows the tutor to know and be able to effectively respond whenever learners have any learning difficulties.

The tutor needs tools to perform and organize follow-up tasks, keep structured traces of learners and groups' activities, have easy access to these traces and be able to summarize them quickly. A path that seems particularly promising to

Badr Hssina, Belaid Bouikhalene, and Abdelkrim Merbouha are with the Sultan Moulay Slimane University, Faculty of sciences and technology Beni Mellal, Morocco; (e-mail:hssina.badr@hotmail.fr, bbouikhalene@yahoo.fr, merbouhak@yahoo.fr).

meet the needs of tutors is the exploitation of interaction traces left by users and the development of indicators that can help the tutor in their monitoring task [4]. Several research studies have focused on the analysis of interaction data and the development of cognitive, social and emotional indicators [12]. By analyzing the different indicators reported in the literature, it becomes clear that the definition of some indicators requires specific competencies such as the didactics of the teaching area, sociology and social network analysis among others. It is thanks to this that the idea of reusing indicators, presented in this work, springs.

We adopt a modeling approach by agents to the design and development of our prototype MASET (Multi Agents System for E-Tutoring Learners engaged in online collaborative work). The reason behind implementing our system with SMA technology (multi-agent system) is its ability to adapt to changes and developments. In fact, SMA's distributed nature, the locality of its reasoning, the possibility of addition and removal of agents in the same operation greatly facilitate the system's adaptability to any changes.

The tutor is based on some calculated indicators extracted from discussions in forums and messages exchanged between students in each group over a period of time. These indicators allow the tutor to identify groups where there has been a debate in the forum and those in which there are no interactions which require his intervention to initiate interactions.

The evaluation of this experiment shows that tutors, using MASET during training, manage to derive qualitative information about the activity of learners and groups, and thus be able to estimate both the need for action and when to choose the most appropriate time to do it.

## II. THE INDICATORS OF LEARNERS' PRODUCTIVITY CALCULATED BY AGENTS

The needs of tutors at follow-up collaborative learning activities are the subject of several automatic interaction analysis systems [13] have been developed, integrating cognitive, social and emotional indicators to help tutors in the monitoring of learners and groups.

The following diagram reveals indicators calculated by MASET to assist the collaborative work of learners. The tutor agent collects these indices to communicate with the tutor actor:

Building on the work of [14]-[18], we identify two types of indicators.

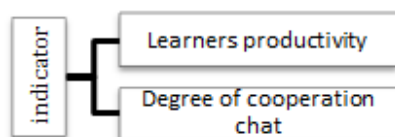

Fig. 1 Indicators calculated by MASET

These indicators can be classified into two categories:

- Learners Indicator productivity
- Social character indicator

For the first category "Learners Indicator productivity", we have chosen to implement the index "learners' Productivity in the forum." This indicator is calculated from data collected from the forum spaces based on the number of documents filed by each learner.

The second category "social character Indicators": These indicators refer to the mode or the quality of communication and collaboration within a group. These indicators relate to activity and contributions of other members in the group workspace and are based on simple indicators such as:

"Indicators of collaboration" This type of indicator reflects the quality of interactivity during an activity. The index "degree of interactivity for learners chat" which calculates the number of messages exchanged in the chat per period.

### III. INTELLIGENT AGENTS AND MULTI-AGENT SYSTEM (MAS)

However, we will start with a brief overview of the concepts of intelligent agents [19] and multi-agent system and a brief introduction to the JADE multi-agent platform [2] we use.

Intelligent agents are artificial intelligence tools commonly used in e-Learning. Here are some selected definitions of intelligent agent concept:

- Russell & Norvig [15], the concept of intelligence agent Artificial refers to "Anything That Can Be viewed as Perceiving it environment through sensors and acting upon That environment through effectors."
- Patti Maes[16], agents are seen as "computational systems that inhabit some complex dynamic environment, sense and act autonomously in this environment, and by doing so realize a set of goals or tasks for which they are designed".
- Finally IBM[17] described as agents: "software entities that carry out some set of operations on behalf of a user or another program with some degree of independence or autonomy, and in doing so, employ some knowledge or representations of the user's goals or desires".

According to these definitions, we define an agent as a software entity with the capacity to perceive its environment and act more or less autonomously to achieve a goal.

We quote later what platform to use for the development of multi-agent systems:

**MADKIT:** (Multi-Agent Development Kit) was developed in 1998 at LIRMM (Montpellier) by Olivier Gutcheck is a flexible platform agent, capable to support multiple communication models simultaneously.

**JADE:** (Java Agent DEvelopment) is a development framework of multi-agent systems, open source and based on the Java language. In particular, it provides advanced support of the FIPA-ACL standard [7], as well as syntax validation tools messages between agents based on ontologies [9].

**GAMA:** GAMA (Gis & Agent-based Modeling Architecture): A concentrated platform capacity at the complex geographic information system (GIS) as an environment for agents, the ability to process a large number of agents, the ability to provide a platform for automated control experience and the ability to easily interact with agents in simulations.

**JADEX:** JADEX is a multi-agent platform developed in Java by the University of Hamburg, compatible with many standard and capable of developing agents following the BDI model (Belief Desire Intention).

TABLE I  
 COMPARISON BETWEEN DIFFERENT PLATFORMS

characteristic	GAMA	JADEX	MADKIT	JADE
State	Free software	Free software	Generic.	Free software
Documentation	Average availability.	Average availability.	Average availability	High availability
Compliance FIPA	Compliant	Compliant	No compliant	compliant
Language programming	JAVA	JAVA, KQML, XML	GAML	JAVA, XML

In summary, we can say that all four platforms discussed in this section meets the needs of developers. Each provides the right tools to allow agents to communicate it either internally with agents that are on the same node or externally with agents that are on different nodes

### IV. THE MULTI-AGENT PLATFORM JADE

The JADE platform (Java Agent Development Framework) [5]-[6] is used for the implementation and management agents. JADE is completely developed in JAVA, following the specifications issued by the agency FIPA (Foundation for Intelligent Physical Agent) [7], a group of industrial and academic researchers have proposed many standards in connection with the agents.

Jade is a middleware that facilitates the development of multi-agent systems (MAS).

The next section is a brief description of the main characteristics of JADE. JADE contains:

- A Runtime Environment: the environment where agents can live. This runtime environment must be enabled in order to launch the agents.
- A library of classes that developers use to write their agents
- A suite of graphical tools that facilitate the management and supervision of the platform agents.

Each instance of the JADE is called "Container" and may contain multiple agents. A set of containers are a **platform**. Each platform must contain a special container called **main-container** and all other containers register with this one from launch.

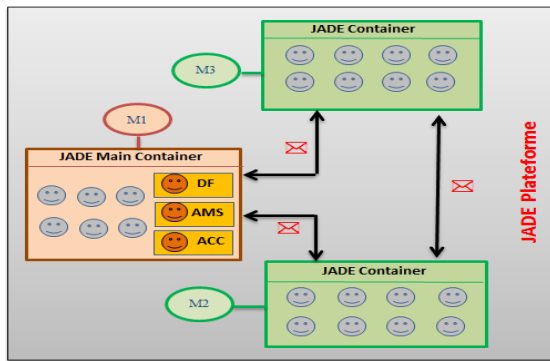

Fig. 2 Architecture of the Jade platform

A main-container differs from other "simple" containers in that it always contains three special agents called AMS (Agent Management System), DF (Directory Facilitator) and ACC (Agent Communication Channel) [10] that are automatically launched at the launch of the main-container.

Another special agent to monitor communications between other agents is (Sniffer Agent): This agent specializes in monitoring streams of communication between agents.

✓ Behaviors

In JADE, agents are autonomous in the sense of independence of operation. In practice, they are characterized by their ability to perform a set of tasks. These tasks are called "behaviors".

✓ FIPA-ACL Language

A language of communication is necessary for all SMA for interaction between different agents [8]. This language is based on communication acts theory [9]. In addition, a message between agents will be directly linked to an action or a very specific act of communication. In this language, a number of communicative acts, called "Performative", are defined. These communicative acts are used to label a message based on its overall objective.

V. MODELING AUML (AGENT UML)

AUML (Agent UML) [20] is a notation to support the development of agent-oriented systems. It uses the UML language and extends it to represent the agents, their behavior, and the interactions between them. In this section, we propose to use AUML to model the interaction between agent protocols.

SMA is generally characterized, as elaborated in the above section, by the ability of exchange and communication between agents defined therein. Our prototype is developed based on the JADE platform; these exchanges use the ACL language. In what follows, we present some interactions MASET implanted in our system. These communications use the list of ACL performative.

As explained above, the tutor agent can interact with other agents that are responsible for providing services. Fig. 3 illustrates the protocol that governs this type of interactions.

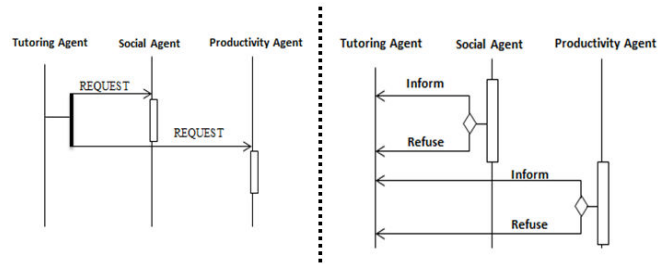

Fig. 3 Communication protocol between agents MASET

Fig. 4 represents the system sequence diagram:

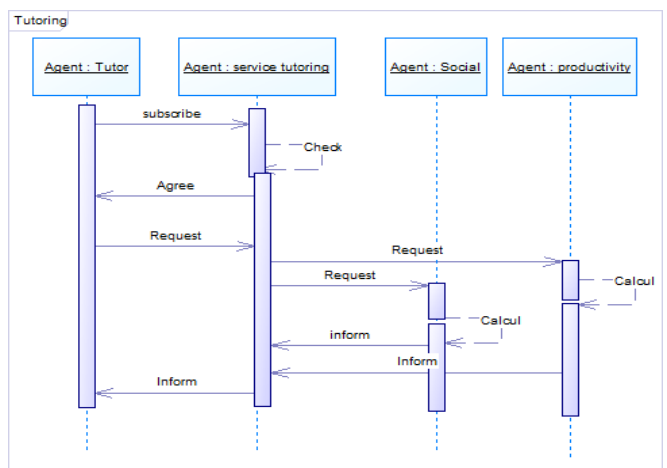

Fig. 4 The sequence diagram of MASET

VI. DESCRIPTION OF MASET SYSTEM

Our prototype (MASET) incorporates JADE middleware and e-learning Moodle platform to monitor collaborative work between the learner and easy online tutoring for Tutor actor.

MASET we propose is a system that has as main objective the analysis of interactions to assist the tutor in monitoring learners and groups. The evaluation of the interaction by the tutor based on the results provided by the automatic analysis of the interaction indicators. Originally, these indicators have been developed in different environments. To help achieve these goals, we have opted for a multi-agent architecture. The agents communicate and collaborate with each other to achieve the tasks entrusted to them.

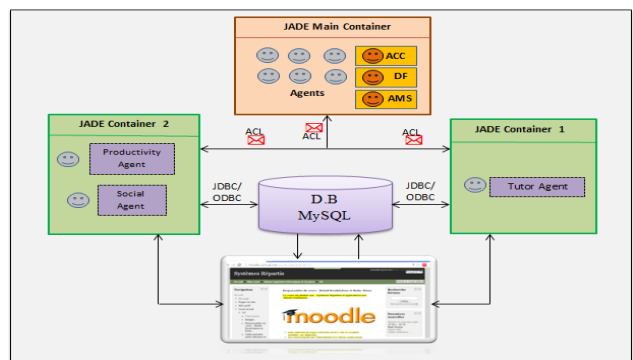

Fig. 5 MASET Architecture System

A distributed multi-agent system was created on mobile devices that support the Android system and on computers desktops. This application allows a teacher to monitor the activities of learners in the forums and chat sessions.

We created three agents which are Tutor Agent, Social Agent and Productivity Agent; each of these agents works as already explained in the diagram above.

- The Tutor Agent's interface allows the agent to be deployed by entering the IP address of the machine that contains the main-container and name.



Fig. 6 The login interface for tutor

The social agent and productivity agent are deployed on a container on the central computer that contains the main-container. It is in this computer where all other agents will be deployed because it contains the main-container.

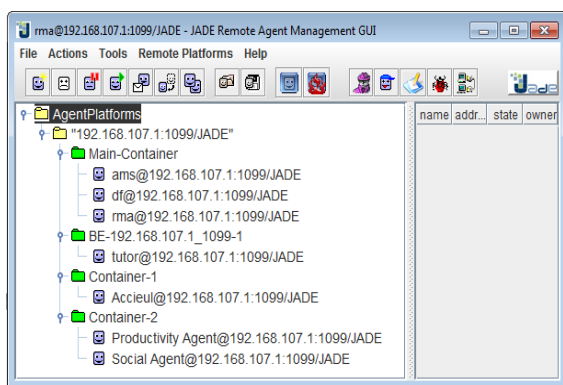

Fig. 7 JADE Remote Agent Management GUI of MASET

ID_Apprenant	Indice_doc_forum	Indice_msg_chat
1	0.11	0.12
2	0.05	0.03
3	0.05	0.06
4	0.0	0.03
5	0.11	0.04
6	0.11	0.04
7	0.05	0.0
8	0.17	0.02
9	0.05	0.02
10	0.05	0.04
11	0.0	0.09
12	0.0	0.08
13	0.17	0.0
14	0.0	0.0
15	0.0	0.0
16	0.17	0.0
17	0.0	0.0
18	0.0	0.0
19	0.0	0.0
20	0.0	0.0
21	0.0	0.0
22	0.0	0.0
23	0.0	0.0
24	0.0	0.0

Fig. 8 The results of calculations of the indicators

These last two agents use a display interface of interactions stored in the database.

This interface is used to display the results of the calculated indicators returned by agents.

## VII. RESULTS AND EVALUATION

To evaluate our MASET multi-agent system, an experiment has been conducted among 24 master students of Computer Engineering and System. A number of courses and practical work have been uploaded to our University Moodle platform, courses that are part of a training module. The collaboration between students is required when carrying out their activities.

The analysis of the interactions between students using agents and automatic analysis indicators is illustrated by the following figures.

Productivity agent is responsible for calculating the indicator of productivity of students in the forum:

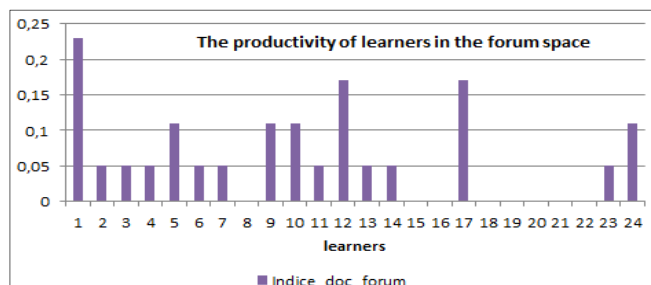

Fig. 9 The productivity of learners in the forum space

Social agent is responsible for calculating degree of learners' interactions in chat:

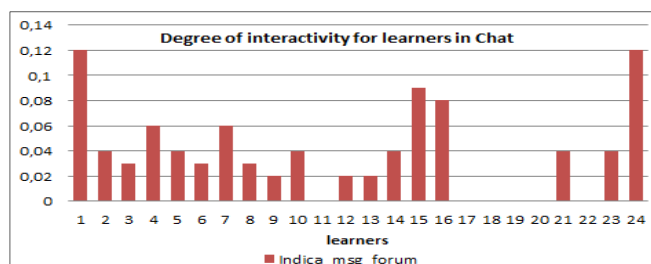

Fig. 10 Degree of interactivity of learners in the forum space

## VIII. CONCLUSION

This article stresses the importance of using a multi-agent approach to building the concrete implementation of MASET.

It also presents the specifications that we have followed for developing the MASET prototype, a prototype which has been put into practice among university students in an e-learning Moodle platform. Subsequently, we introduced the automatic analysis of the interaction indicators. This prototype's main objective is to help tutors in monitoring the collaborative work of students and their various interactions.

REFERENCES

- [1] Blanchard, E., Razaki, R., Frasson, C. (2005). Cross-cultural adaptation of e-Learning: a methodology. International Conference on e-Learning (ELEARN2005), Vancouver, Canada.
- [2] Wooldridge, M. (2002). An Introduction to MultiAgent Systems. Chichester, England: John Wiley & Sons.
- [3] P. Brusilovski, "Distributed Intelligent Tutoring on the Web". 8th World Conference of Artificial Intelligence in Education. IOS Press. pp. 482-489, 1997.
- [4] Aleven, V., McLaren, B., Roll, I., Koedinger, K. (2004). Toward tutoring help seeking: applying cognitive modeling to meta-cognitive skills. Intelligent Tutoring Systems (ITS 2004), Springer-Verlag LNCS 3220, Maceio, Alagoas, Brésil, pp. 227-239.
- [5] G. Caire and D. Cabanillas, "JADE tutorial: creating and using application specific ontologies", 2004.
- [6] Jade. (2009). Java Agent Development Framework, <http://jade.tilab.com>.
- [7] FIPA00037. (2002). FIPA ACL communicative act library specification. Technical report, FIPA..
- [8] FIPA ACL Message Structure Specification. Accessible en ligne à :<http://www.fipa.org/specs/fipa00061/SC00061G.html>.
- [9] Bailin and Truszkowski, 2002 Sidney C. Bailin and Walt Truszkowski. Ontology
- [10] <http://jade.tilab.com/> Website JADE (Java Agent DEvelopment Framework).
- [11] Guéraud, V., Michelet, S., Adam, J "Suivi de classe à distance: propositions génériques et expérimentation en électricité", Environnements Informatiques pour l'Apprentissage Humain, Lausanne 2007.
- [12] Dimitracopoulou, A., Bruillard, E. (2007). Enrichir les interfaces de forums par la visualisation d'analyses automatiques des interactions et du contenu, Revue STICEF, Volume 13, 2006, ISSN : 1764-7223, mis en ligne le 21/02/2007.
- [13] Charlier, Daele, Docq, Lebrun, Lusalusa, Peeters, Deschryver (1999). Tuteurs en ligne : quels rôles, quelle formation? Deuxièmes Entretiens internationaux sur l'enseignement à distance, CNED, Poitiers, France, p. 337-345.
- [14] Bratitsis, T., Dimitracopoulou, A. (2006). Indicators for measuring quality in asynchronous discussion forums, International Conference on Cognition and Exploratory Learning in Digital Era (CELDA2006), IADIS (International Association for Development of the Information Society) 8-10 December, 2006, Barcelona, Spain.
- [15] Russell, S., Norwig, P. (2003). Artificial Intelligence: A Modern Approach (2nd ed.). Upper Saddle River, NJ: Prentice Hall.
- [16] Maes, P. (1995). Artificial life meets entertainment: life like autonomous agents. Communications of the ACM, vol. 38 (11), pp. 108-114.
- [17] Gilbert, D., Aparicio, M., Atkinson, B., Brady, S., Ciccarino, J., Grosz, B., O'Connor, P., Osisek, D., Pritko, S., Spagna, R., Wilson L. (1995). The role of intelligent agents in the information infrastructure. IBM Report.
- [18] Angélique Dimitracopoulou, Éric Bruillard « Enrichir les interfaces de forums par la visualisation d'analyses automatiques des interactions et du contenu » Volume 13, 2006
- [19] Wooldridge, M., Jennings, N. R. (1995). Intelligent agents: theory and practice. The knowledge engineering review, vol. 10(2), pp. 115-152
- [20] Abdelhamid Zouhair, El Mokhtar En-Naimi, Patrick Person, Cyrille Bertelle «Our System IDCBR-MAS: from the Modelisation by AUML to the Implementation under JADE Platform» LIST Lab, The University of Abdelmalek Essaâdi, FST of Tangier, Morocco LITIS Lab, The University of Le Havre, France.