

Design and Characterization of CMOS Readout Circuit for ISFET and ISE Based Sensors

Yuzman Yusoff, Siti Noor Harun, Noor Shelida Sallehand, Tan Kong Yew

Open Science Index, Electronics and Communication Engineering Vol:7, No:10, 2013 publications.waset.org/10001593.pdf

Abstract—This paper presents the design and characterization of analog readout interface circuits for ion sensitive field effect transistor (ISFET) and ion selective electrode (ISE) based sensor. These interface circuits are implemented using MIMOS's 0.35um CMOS technology and experimentally characterized under 24-leads QFN package. The characterization evaluates the circuit's functionality, output sensitivity and output linearity. Commercial sensors for both ISFET and ISE are employed together with glass reference electrode during testing. The test result shows that the designed interface circuits manage to readout signals produced by both sensors with measured sensitivity of ISFET and ISE sensor are 54mV/pH and 62mV/decade, respectively. The characterized output linearity for both circuits achieves above 0.999 Rsquare. The readout also has demonstrated reliable operation by passing all qualifications in reliability test plan.

Keywords—Readout interface circuit (ROIC), analog interface circuit, ion sensitive field effect transistor (ISFET), ion selective electrode (ISE), ion sensor electronics.

I. INTRODUCTION

ION sensor is a quick and convenient analytical device that can provide real time information on the existence and the concentration of specific ions in aqueous solution [1]. Among various classes of ion sensors, ion selective electrode (ISE) and ion sensitive field effect transistor (ISFET) are the most frequently used potentiometric sensors during laboratory analysis as well as in industry, process control, medical diagnosis, and environmental monitoring.

Ion sensing membrane is the key component of all ion sensors. It establishes the preference of a sensor to respond to the ion of interest in presence of other ionic components. The flow of target ions across the sensing membrane produces electrical signal that corresponds to ion concentrations [2]. To capture this signal, specific readout interface circuits are required [3]-[8].

In this paper, the implementation and characterization of readout circuits for ISFET and ISE sensors are presented. This paper is divided into four additional sections. Section II briefly describes the principle ion sensors, specifically ISFET and ISE. The design implementation of both readout circuits is presented in section III. Section IV discusses on measurement results and; finally the conclusions are drawn in Section V.

Yuzman Yusoff, Siti Noor Harun, Noor Shelida Salleh, and Tan Kong Yew are with the MIMOS Berhad, Technology Park Malaysia, 57000 Kuala Lumpur, Malaysia (phone: 603-89955000; fax: 603-89914234; e-mail: yuzman@mimos.my, sitinoor.harun@mimos.my, shelida@mimos.my, kongyew.tan@mimos.my).

II. ION SENSORS

An ISFET sensor is similar to conventional MOSFET except for standard poly gate is replaced by a reference electrode that is inserted in the chemical solution (electrolyte) as shown in Fig. 1. At the interface between the gate insulator and solution, there is an electric potential difference that depends on the concentration of hydrogen ion (H⁺) of the solution or known as pH value. The variation of this potential caused by the pH variation will lead to modulation of the drain current.

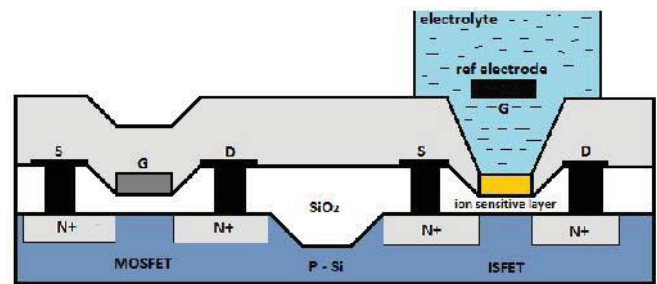

Fig. 1 MOSFET and ISFET devices

The model of a conventional MOSFET device can also define an ISFET sensor as in (1). The only difference is that the threshold voltage of MOSFET is replaced by the threshold voltage of ISFET [9].

$$I_{DS} = \mu_n C_{ox} \frac{W}{L} (V_{GS} - V_{TH\ ISFET}) V_{DS} - \frac{1}{2} V_{DS}^2 \quad (1)$$

The I_{DS} is drain current, μ_n is mobility of electron carriers in semiconductor layer, C_{ox} is oxide capacitance density, W/L is device aspect ratio, V_{GS} is gate-source voltage, V_{DS} is drain-source voltage and $V_{TH\ ISFET}$ is the threshold voltage of ISFET. With gate region exposed to the chemical solution, the threshold voltage of ISFET change accordingly with the activity of ions in chemical solution. This electrochemical phenomenon is defined as in (2) and (3).

$$V_{TH\ (ISFET)} = V_{TH\ (MOS)} - V_{CHEMICAL} \quad (2)$$

$$V_{CHEMICAL} = E_i + \frac{RT}{n_i F} \ln(a_i) \quad (3)$$

The $V_{CHEMICAL}$ is electrochemically induced voltage in the threshold voltage of ISFET, $V_{TH\ MOS}$ is the MOSFET threshold voltage, E_i is chemical constant, R is a gas constant, T is absolute temperature in Kelvin, F is Faraday constant, n_i

is charge of ion i , and a_i is ion activity of ion i . Equation (4) includes the effect of ion activity to ISFET electrical characteristic.

$$I_{DS} = \mu_n C_{ox} \frac{W}{L} V_{DS} \left[V_{GS} - V_{TH(MOS)} + \left| E_i + \frac{RT}{n_i F} \ln(a_i) \right| - \frac{1}{2} V_{DS} \right] \quad (4)$$

When ISFET is connected to a readout circuit, the output voltage V_{OUT} is usually the gate-source voltage V_{GS} of ISFET [10]. From (5), the V_{GS} of ISFET is proportional to the logarithmic function ion activity a_i . Thus, the V_{OUT} of read-out circuit reflect the ion activity.

$$V_{GS} = \frac{I_{DS}}{\mu_n C_{ox} (W/L) V_{DS}} + V_{TH(MOS)} - E_i - \frac{RT}{n_i F} \ln(a_i) + \frac{1}{2} V_{DS} \quad (5)$$

Ion-selective electrode (ISE) is an electrochemical sensor based on thin film or selective membrane as recognition element. The scheme of ISE is shown in Fig. 2.

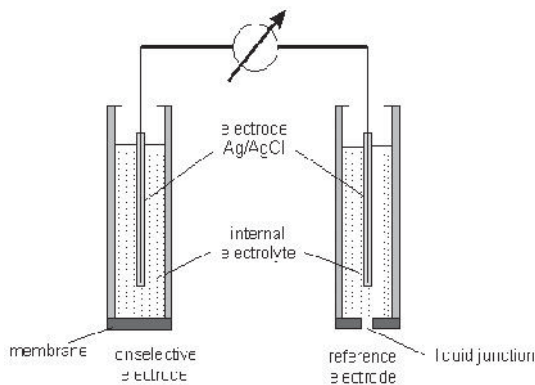

Fig. 2 Operational principle of an ISE

In order to measure the electrode potential developed at the ion-selective membrane, the ISE electrode must be immersed in the solution together with a separate reference electrode. At equilibrium, the electrons added or removed from the solution by the ISE membrane (depending on whether it is cation or anion sensitive) are balanced by an equal and opposite charge at the reference interface. This causes a positive or negative deviation from the original stable reference voltage [11]. The relationship between the ionic concentration (activity) and the electrode potential is given by the Nernst equation (6).

$$E = E_0 + \left(\frac{2.303RT}{nF} \right) \text{Log}[a_i] \quad (6)$$

where E is the total potential (in mV) developed between the sensing and reference electrodes. The E_0 is related to the potential of the reference electrode, $(2.303RT/nF)$ is the Nernst factor, and a_i is the ionic activity. The Nernst factor $(2.303RT/nF)$ includes the Gas Law constant (R), the temperature in degrees Kelvin (T). Faraday's constant (F) and the charge of ion (n).

III. DESIGN IMPLEMENTATIONS

To monitor the change of ion activity, ISFET have to operate in the linear region and should maintain constant voltage constant current (CVCC) mode. These conditions make the gate-source voltage (V_{GS}) proportional to the internal ISFET's threshold voltage (V_{TH}).

The designed readout circuit for ISFET based sensor is shown in Fig. 2. It consists of three major parts; CVCC circuit, temperature sensor and summing circuit. CVCC technique is implemented for sensing a signal from sensor due to its robustness. Basically, it is comprises of two operational amplifiers; OP1 and OP2. The OP1 is connected to the source of ISFET while OP2 is connected to the drain and provides a feedback to the ISFET gate. In this way, the gate voltage serves as the output signal in response to electrolyte solutions. To ensure ISFET operates in linear region at fixed V_{DS} , the internal reference voltage for V1 and V2 is set to 0.2V and 0.7V, respectively. These reference voltages are generated from band gap reference circuit to make them independent to temperature and power supply variation. R3 set the ISFET's operating current to maintain at 100uA. OP3 are employed as buffer to improve driving capability.

The ISFET sensor has a drawback of temperature dependency [12]. To accommodate this problem, a temperature sensor is included in this readout circuit to compensate the temperature effect. For CMOS process, we can use parasitic *pnp* or MOS threshold voltage extractor to sense the temperature change. Through summing circuit the positive temperature coefficient of ISFET is cancelled out by adding to negative temperature coefficient of temperature sensor. Programmable gain amplifier (PGA) is employed to adjust the temperature coefficient of temperature sensor to a value close to ISFET's temperature coefficient. Thus, the cancellation can be done to nearly zero value.

The readout circuit for ISE based sensor as shown in Fig. 3. It comprises of three operational amplifiers; OP1, OP2 and OP3. Generally, it is a differential amplifier circuit since ISE itself is a potential device.

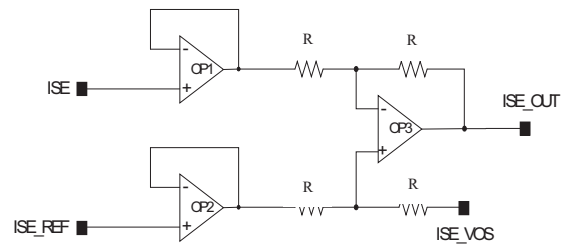

Fig. 3 Read-out interface circuit for ISE based sensor

OP1 and OP2 operate as a buffer where ISE sensor and reference electrode are connected to each of them. ISE_VOS provides option for output voltage level adjustment. The output voltages are given by (7):

$$V_{ISE_OUT} = V_{ISE} - V_{ISE_REF} + V_{ISE_VOS} \quad (7)$$

ISFET readout circuit simulation uses an established behavioral macro-model from Sergio Martinoia and Giuseppe Massobrio [13]. It is based on a modified SPICE MOS transistor model. The model combines in a single set of mathematical equations different chemical, thermal and

electrical phenomena occurring in ISFET sensor device. It is suitable for the simulations of the device operating in a relatively wide range of temperature and hydrogen ion concentration.

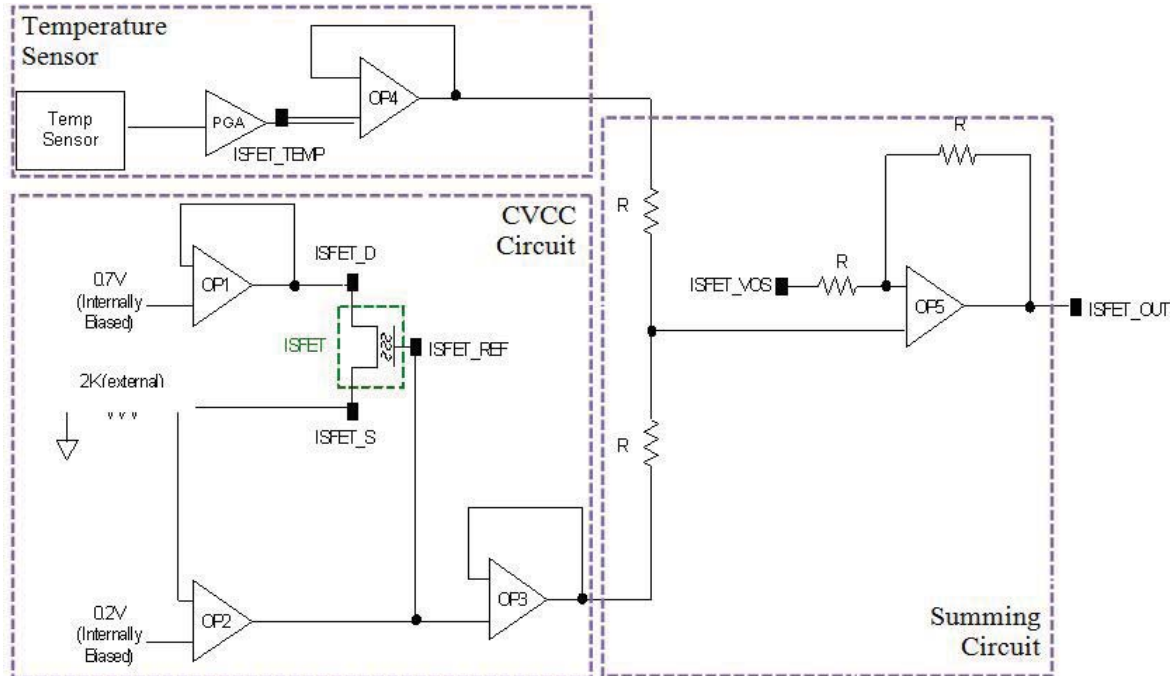

Fig. 4 Readout interface circuit for ISFET based sensor

The complete layout of readout circuits is shown in Fig. 5. It is realized using three metal layers and double polyCMOS process. All necessary layout techniques such as common-centroid, inter-digitized, dummy devices have been implemented to achieve best device matching and for the precision of produced output voltage. The latch-up and ESD protection are also considered in this layout. The layout occupies $(2 \times 2) \text{mm}^2$ silicon area with 48 I/O pads.

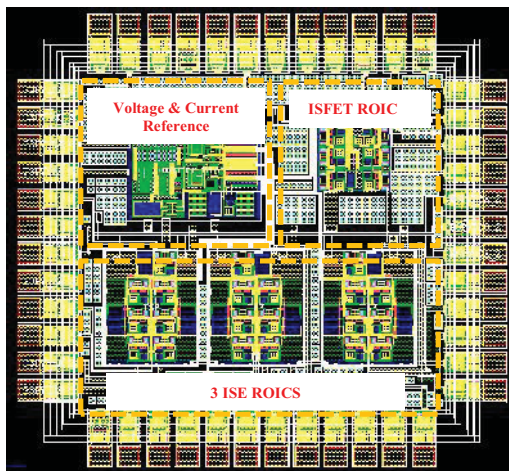

Fig. 5 Physical layout of ISFET and ISE readout circuits. © 2011 MIMOS Berhad

IV. MEASUREMENT

For characterization purposes, the IC of interface circuits is packaged using QFN type with 24-leads. Two separate test boards are prepared with special socket to clinch the IC. Commercial ion sensors and buffer solutions for pH and nitrate (NO_3^-) are used in this characterization. The test results are then benchmarked with the data collected using standard procedures of ion measurement. For ISE, ion concentrations are determined using commercial ion meter from Orion. Meanwhile, ISFET based sensor is analyzed using I-V characteristic. Each type of read-out interface circuit is characterized on their sensitivity and linearity characteristics.

Fig. 6 plots the measured gate-source voltage (V_{GS}) of ISFET using I-V characteristic analysis (standard procedure) and the generated output voltage of designed readout circuit in three different buffer solutions. The output sensitivity and linearity of both conditions are comparable to each other. Fig. 7 shows the potential voltages of ISE sensor to reference electrode in four different concentrations of ion nitrate using commercial ion meter (standard procedure) and the produced output voltage of our readout circuit. Both cases give sensitivity close to 62mV/dec and they are linear.

Voltage vs pH (4,7&10)

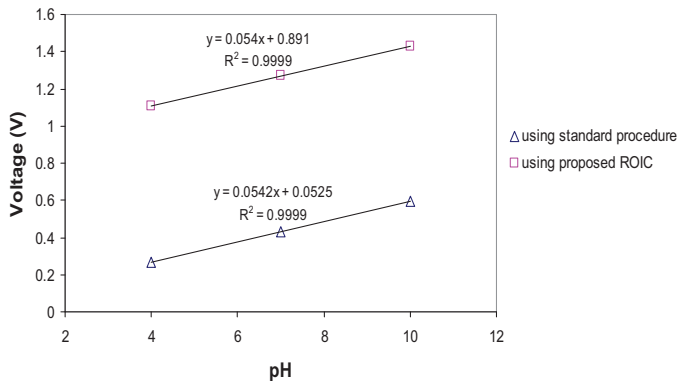

Fig. 6 Test results for ISFET based sensor using standard I-V characterization and proposed readout circuit

Voltage vs. Ion concentration (nitrate)

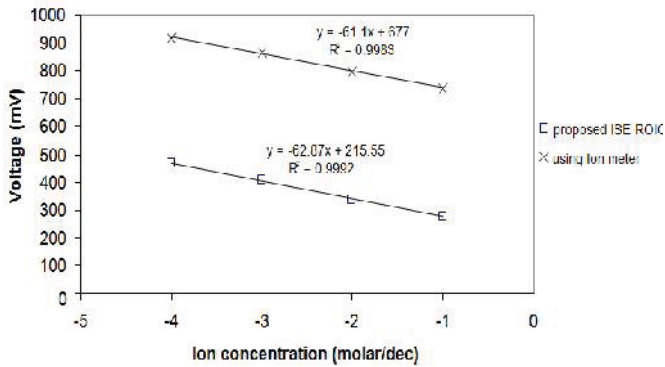

Fig. 7 Test results for ISE based sensor using ion meter and proposed readout circuit

Figs. 8 and 9 show the output voltage of both readout circuits with different supply voltages. As can see on the plot, there is not much variation on the produced output voltage within power supply ranges of 2.4V to 3.6V.

VOUT (ISFET_Out) Vs. VIN (ISFET_REF)

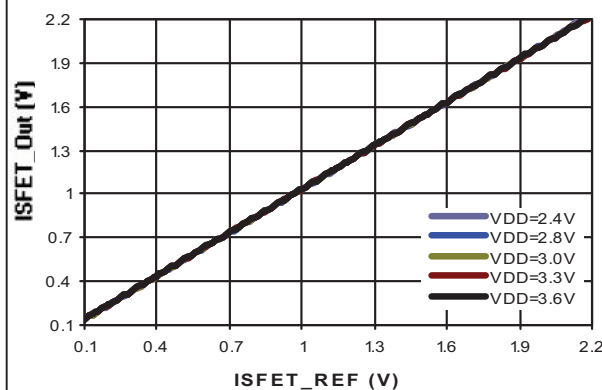

Fig. 8 Output voltage of ISFET readout circuit with different supply voltages. © 2011 MIMOS Berhad

VOUT (ISE_Out_N) Vs. VIN (ISE_N)

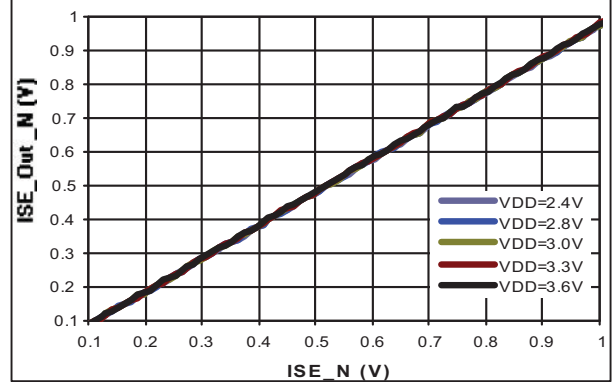

Fig. 9 Output voltage of ISE readout circuit with different supply voltages. © 2011 MIMOS Berhad

The characterized output linearity for ISFET and ISE readout circuits are shown in Figs. 10 and 11. Both circuits manage to achieve high output linearity with above 0.9999 rsquare (rsq).

ISFET ROIC LINEARITY Vs. VDD

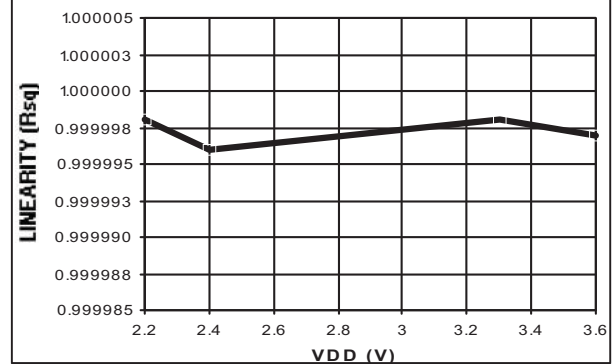

Fig. 10 Output linearity of ISFET readout circuit with different supply voltages. © 2011 MIMOS Berhad

ISE ROIC LINEARITY Vs. VDD

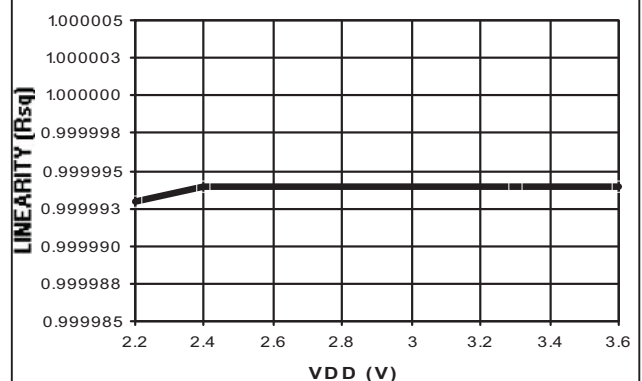

Fig. 11 Output linearity of ISE readout circuit with different supply voltages. © 2011 MIMOS Berhad

Besides output sensitivity and linearity, the internal reference voltages for setting up the drain-source voltage

(V_{DS}) of ISFET are measured. Figs. 12 and 13 show the measured result for drain voltage (V_D) and source voltage (V_S), respectively.

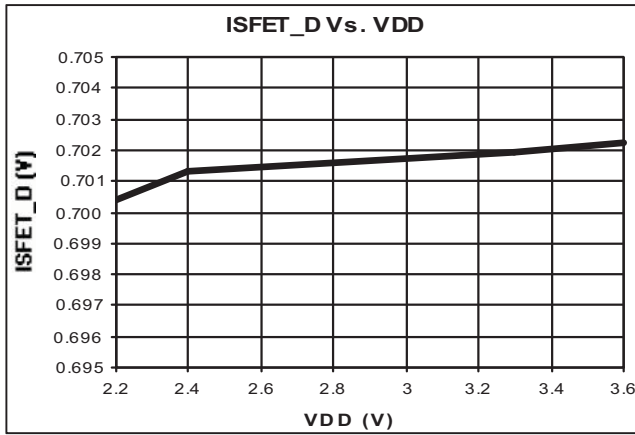

Fig. 12 Measured voltages for drain of ISFET with varies supply voltage. © 2011 MIMOS Berhad

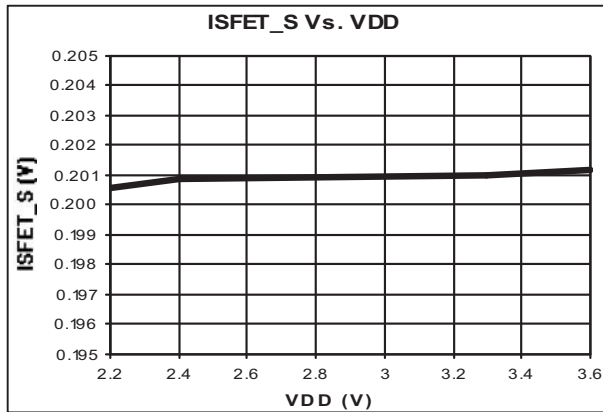

Fig. 13 Measured voltages for source of ISFET with varies supply voltage. © 2011 MIMOS Berhad

On top of functionality test, we also consider reliability test to evaluate our design at component level. Fig. 14 illustrates a flow diagram for the conducted reliability test. The test is done by third party. For this test, 308 ICs were provided to be tested and all of them passed the evaluation specified.

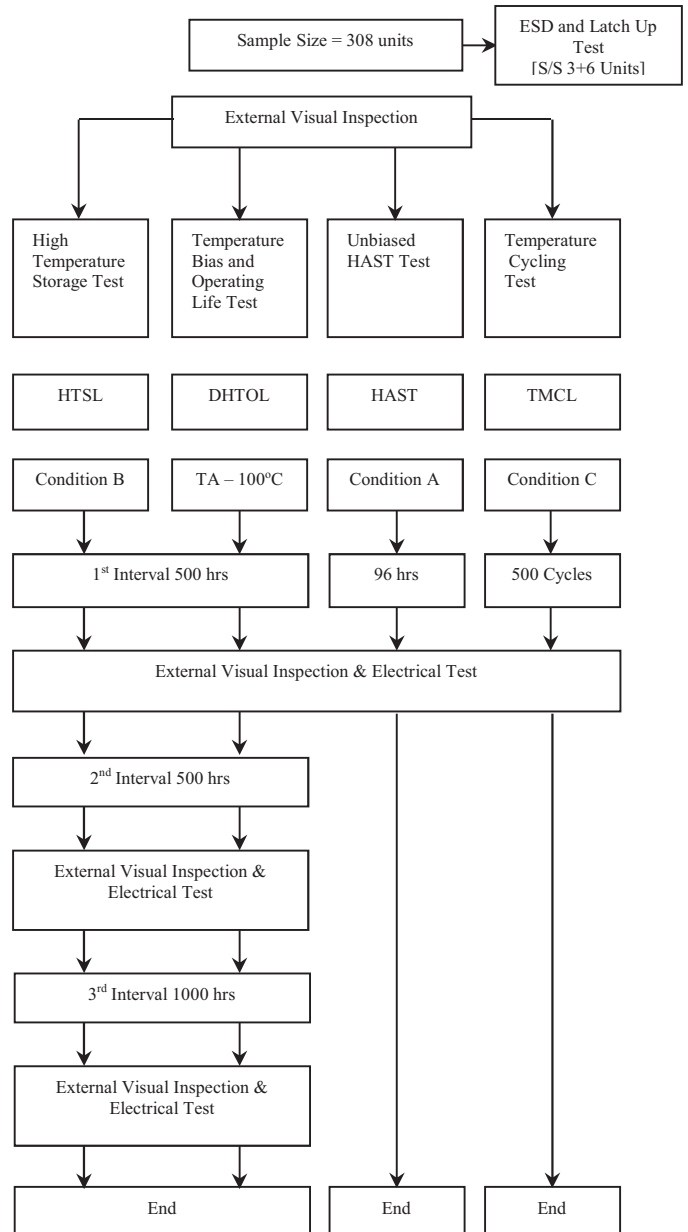

Fig. 14 Flow diagram of reliability test

V. CONCLUSION

The readout interface circuits for ion sensitive field effect transistor (ISFET) and ion selective electrode (ISE) sensor have been developed and characterized. Table I summarizes the characteristics of designed of readout circuits.

REFERENCES

- [1] P. Bergveld, "Development of an Ion-Sensitive Solid-State Device for Neurophysiological Measurement," *IEEE Trans. on Biomed. Eng.*, vol. BME-17, pp.70-71, 1970.
- [2] D. Y. Chen, P. K. Chan and M. S. Tse, "A CMOS ISFET interface circuit for water quality monitoring", *Proc. IEEE Conference on Sensors*, pp. 1217-1220, Nov. 2005.
- [3] B. D. Liu, Y. K. Su and S. C. Chen, "Ion Sensitive Field Effect Transistor with Silicon Nitride Gate for pH Sensing", *Int. J. Electronics*, 67, pp.59-63, 1989.

TABLE I
 READOUT CIRCUITS CHARACTERISTICS

Parameter	Min	Typ	Max
Voltage Supply, V_{DD}	2.4V	3V	3.6
Temperatre	0°C	27°C	60°C
Operating Current, I_{DD}		4mA	
ESD Protection		2kV	
ISFET ROIC			
Internal V_{ISFET_D}		0.7V	
Internal V_{ISFET_S}		0.2V	
Output Linearity, R_{SQ}	0.999		1.0
Output Voltage, V_{OUT}	$(V_{ISFET_REF} + V_{ISFET_TEMP} - V_{ISFET_VOS})$		
ISE ROIC			
Output Linearity, R_{SQ}	0.999		1.0
Output Voltage, V_{OUT}	$(V_{ISE} - V_{ISE_REF} + V_{ISE_VOS})$		

- [4] L. Ravazzi, P. Conci, "ISFET Sensor Coupled with CMOS Read-Out Circuit Microsystem", *Electron. Lett.* 34, pp.2234–2235, 1998.
- [5] B. Palan, F.V. Santos, J.M. Karam, B. Courtois, M. Husak, "New ISFET sensor interface circuit for biomedical applications", *Sens. Actuators B: Chem.* 57, pp.63–68, 1999.
- [6] A. Morgenshtein, L. Sudakov-Boreysya, U. Dinnar, C.G. Jakobson, Y. Nemirovsky, "CMOS Readout Circuitry for ISFET Microsystems", *Sens. Actuators B: Chem.* 97, pp.122–131, 2004.
- [7] W. Y. Chung, C. H. Yang, G. Pijanowska, A. Krzyskow, W. Torbicz, "ISFET Interface Circuit Embedded with Noise Rejection Capability", *Electron. Lett.* 40, pp.1115-1116, 2004.
- [8] W. Y. Chung, C. H. Yang, M. C. Wang, D. G. Pijanowska and W. Torbicz, "Temperature Compensation Electronics for ISFET Readout Application," *IEEE International Workshop on Biomedical Circuit and System*, 2004.
- [9] T. Matsuo, and M. Esashi, "Method of ISFET Fabrication", *Sensors and Actuators*, vol. 1, pp. 77-96, 1981.
- [10] Wen-Yaw Chung, Febus Reidj G. Cruz, Chung-Huang Yang, Fu-Shun He, Tai-Tsun Liu, Dorota G. Pijanowska, Wladyslaw Torbicz, Piotr B. Grabiec and Bohdan Jarosewicz (2010). CMOS Readout Circuit Developments for Ion Sensitive Field Effect Transistor Based Sensor Applications, Solid State Circuits Technologies, Jacobus W. Swart (Ed.), ISBN: 978-953-307-045-2, InTech, DOI: 10.5772/6891.
- [11] P. Bühlmann and L. D. Chen, "Ion-Selective Electrodes with Ionophore-Doped Sensing Membranes". *Supramolecular Chemistry: From Molecules to Nanomaterials*; Wiley; New York, NY: 2012.
- [12] G. H. Wang, D. Yu, and Y. L. Wang "ISFET temperature characteristics," *Sensors and Actuators*, vol. 11, pp. 221-237, 1987.
- [13] S. Martinoia and G. Massobrio, "A behavioral macromodel of the ISFET in SPICE," *Sensors and Actuators B: Chem.* 62, pp.182-189, 2000.