

Experimental Performance and Numerical Simulation of Double Glass Wall

Thana Ananacha

Abstract—This paper reports the numerical and experimental performances of Double Glass Wall are investigated. Two configurations were considered namely, the Double Clear Glass Wall (DCGW) and the Double Translucent Glass Wall (DTGW). The coupled governing equations as well as boundary conditions are solved using the finite element method (FEM) via COMSOL™ Multiphysics. Temperature profiles and flow field of the DCGW and DTGW are reported and discussed. Different constant heat fluxes were considered as 400 and 800 W.m⁻² the corresponding initial condition temperatures were 30.5 and 38.5°C respectively. The results show that the simulation results are in agreement with the experimental data. Conclusively, the model considered in this study could reasonable be used simulate the thermal and ventilation performance of the DCGW and DTGW configurations.

Keywords—Thermal simulation, Double Glass Wall, Velocity field.

I. INTRODUCTION

NOWADAYS the buildings have high energy consumption of air conditioning systems because the tropical climate of Thailand. One solution is the reduction of heat transfer into the habitants. An important part of building energy saving comes from mirror material types and its configurations. Thus, many researchers [1]-[4] try to find the new design with well energy saving.

In fact, various double pane configurations and theoretical and experimental studies are available [5]-[7] and more details for daylighting effect reported the Double Clear Glass Wall (DCGW) and Double Translucent Glass Wall (DTGW) developed by Faculty of Architecture and Design of King Mongkut's University of Technology North Bangkok (KMUTNB) [8]. Experimental results were showed the average indoor illuminance of DTGW and DCGW was higher than the standard illuminance by about 1,500 lux and 2,000 lux, respectively. The air flow rate and number of air change by about 0.0025- 0.004 m³/s (9-14.4 m³/hr) and 2-14 ACH, respectively.

This paper aims to conduct experimental and numerical simulation to study the performance of the Double Clear Glass Wall (DCGW) and Double Translucent Glass Wall (DTGW).

II. EXPERIMENT SETUP

The small houses for experiment are shown in Fig. 1. The DCGW put to comparison with DTGW. The sizing of the

T. A. is with the Department of Architecture, Faculty of Architecture and Design, King Mongkut's University of Technology North Bangkok, 1518 Pracharat 1 Road, Wongsawang, Bangsue, Bangkok 10800, Thailand (phone: +66 2 586 7313; fax: +66 2 587 4350; e-mail: thanaa@kmutnb.ac.th).

DCGW is same dimensions with DTGW and sizing was 0.14 x 0.60 x 2.14 m. The DCGW is made of double layers consisted of clear glass pane 0.60 x 2.00 x 0.06 m with an air gap and openings located at the bottom (room side clear glass pane) and at the top (ambient side). The size of openings was 0.14 x 0.60 m² and 0.14 m air gap. The different of DTGW is translucent glass installed outer side. They were integrated into the south facing of two small houses. The sizings of the room were 1.50 x 1.50 x 2.40 m. The wall and ceiling were built by gypsum board. They were located on the top floor of 4th floor commercial building at the Phoem Sin Road, Khlong Thanon, Sai Mai, Bangkok, Thailand.

Two types of the wall are considered as follows:

- 1) Double Clear Glass Wall (DCGW)
- 2) Double Translucent Glass Wall (DTGW)

The different materials used for constructing the models are as follow:

- 1) Clear glass (w) 10 cm, (L) 200 cm, 6 mm thk.
- 2) Translucent glass (w) 10 cm, (L) 200 cm, 6 mm thk.

Fig. 2 showed the measuring positions of the experimental set-up.



Fig. 1 The double glass wall models in the experiment (DCGW and DTGW)

III. SIMULATION MODEL

To simulate the thermal performance of double glass wall we used commercial software, COMSOL™ Multiphysics. The analytical model is shown in Fig. 3 (a). In order to obtain a good approximation, a fine mesh is specified in the sensitive areas as shown in Fig. 3 (b).

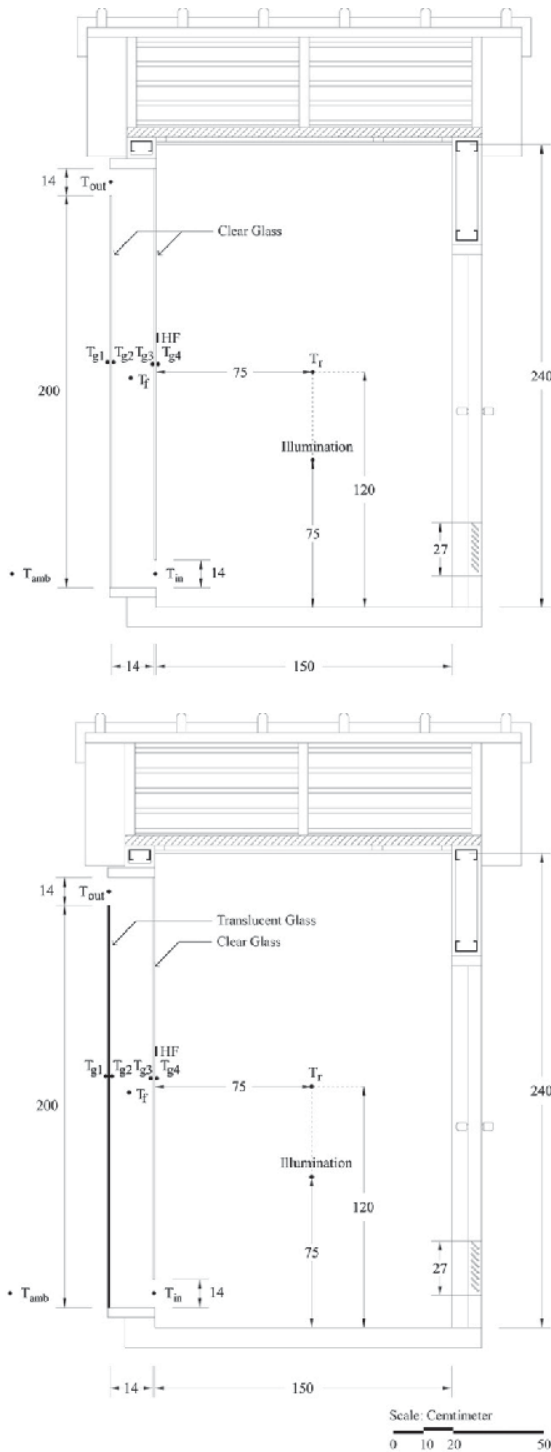

Fig. 2 The position of thermocouples of the DCGW and DTGW

To reduce complexity of the problem, several assumptions have been made as follows:

- 1) Heat transfer is considered as steady state condition.
- 2) Heat transfer occurs in two-dimension along the cavity.
- 3) Thermal properties and physical properties are constants.
- 4) Air leakage effect is negligible.
- 5) Dust and dirt in the cavity are negligible.
- 6) The other walls, floor and roof are insulated.

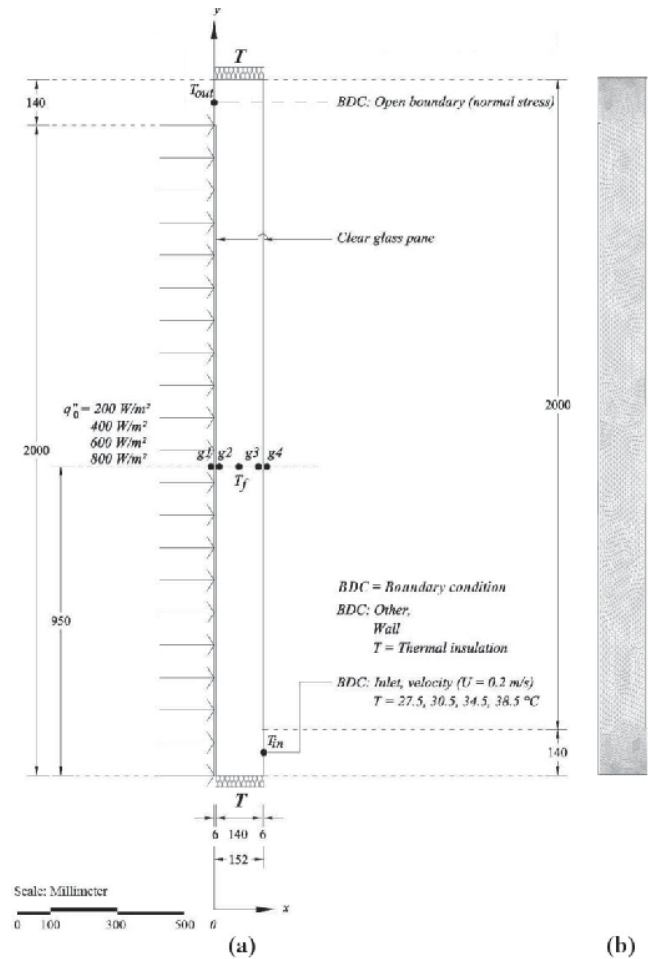

Fig. 3 Schematic diagram of the DCGW and DTGW

A. Heat Transfer Equation

The governing equations for the heat transfer of the clear glass pane are given as:

$$\nabla \cdot (-k\nabla T) = Q - \rho C_p u \cdot \nabla T \quad (1)$$

where: k is thermal conductivity of material [$W \cdot m^{-1} \cdot K^{-1}$], T is Temperature [K], Q is Heat source, ($Q = 0$), ρ is Density of material [kg/m^3], C_p is Specific heat capacity of material [$kJ \cdot kg^{-1} \cdot K^{-1}$], u is velocity of air [$m \cdot s^{-1}$]

B. Thermal Boundary Conditions

- 1) At solid surfaces; the walls, floor and roof are considered insulated; the thermal boundary condition is therefore:

$$n \cdot (k\nabla T - \rho C_p T u) = 0 \quad (2)$$

At the surface of the clear glass pane in the left side which gets sunlight, the boundary condition at this surface is considered constant surface heat flux. In this study we used various heat fluxes for simulations namely $q'' = 400, 800 W/m^2$.

- 2) Initial condition; furthermore, the temperature of air at the inlet of cavity is assumed to be uniform: (add to nomenclature not included) It varies depending on the

intensity of considered incident heat flux considered; the values considered are $T_0=30.5^\circ\text{C}$ for $q''=400\text{ W/m}^2$, $T_0=38.5^\circ\text{C}$ for $q''=800\text{ W/m}^2$. In fact the initial temperature considered (27.5°C) is the average ambient temperature throughout the year in Thailand [9].

- At openings; the boundaries for heat transfer analysis of inlet and outlet are considered a convective flux boundary condition:

$$n \cdot (-k\nabla T) = 0 \quad (3)$$

C. Flow Field Equation

The Navier-Stokes equation used to represent the air flow in the cavity. Using standard symbols, the governing equations describing the flow field of air are given as follows:
 Continuity equation:

$$\nabla \cdot u = 0 \quad (4)$$

Momentum equation:

$$\rho u \cdot \nabla u = \nabla \cdot [-pI + \eta(\nabla u + (\nabla u)^T)] + F_y \quad (5)$$

where:

$$F_y = \rho g \beta (T - T_\alpha) \quad (6)$$

F_y is volume force - y-dir [N/m^3], P is pressure [Pa], η is dynamic viscosity [$\text{Pa} \cdot \text{s}$], g is gravitational constant, $= 9.81\text{ m}\cdot\text{s}^{-2}$, β is coefficient of thermal expansion, $= 1 \times 10^{-4}\text{ 1/K}$, T_α is reference temperature, $T_\alpha = T_0\text{ K}$

D. Boundary Condition for Flow Field

The outer surface of walls, floor and roof, a no slip boundary condition is applied for the momentum equations:

$$u = 0 \quad (7)$$

The velocity of air at the inlet of cavity is considered as uniform. In the simulation the value used is

$$u = 0.2\text{ m} \cdot \text{s}^{-1} \quad (8)$$

IV. RESULTS AND DISCUSSION

Testing performance of DCGW and DTGW was conducted during November to December. The air gap space of DCGW and DTGW were fixed at 0.14 m. The opening air vents at the ambient side and the room sides are of equal size ($0.14\text{ m} \times 0.60\text{ m}$). The total surface area of each was 1.284 m^2 . The data analysis required reaching a relative study state.

A. Temperature Profiles

1) Experimental Results

Temperature profile at different measured positions of the DCGW and DTGW are shown in Figs. 4 and 5 respectively. As expected and due to the effect of external Translucent glass of DTGW, the temperatures of various measured positions of the DTGW are lower than those of the DCGW configuration.

Obviously, the temperature difference depends on the prevailing conditions. The temperature of the inner surface of clear glass pane outside (T_{g2}) and the inner surface of clear glass pane inside (T_{g4}) are much higher when compared to those of DTGW. This is due to the contribution of heat associated with the incident solar radiation through the clear glass slats. Consequently, the temperature of room-side gypsum board of the DCGW is 1 to 2°C higher than that of the DTGW.

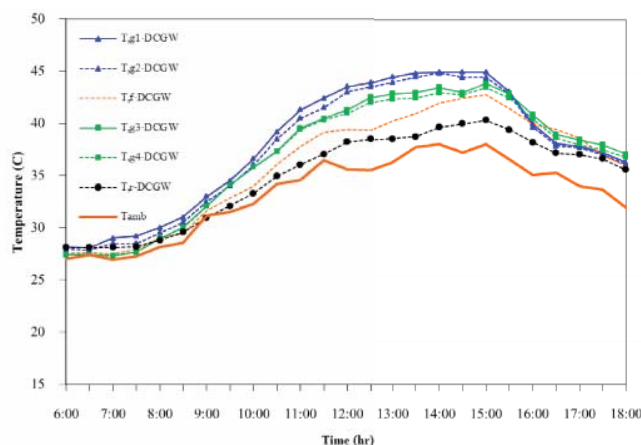

Fig. 4 Hourly variation of measured temperature of DCGW

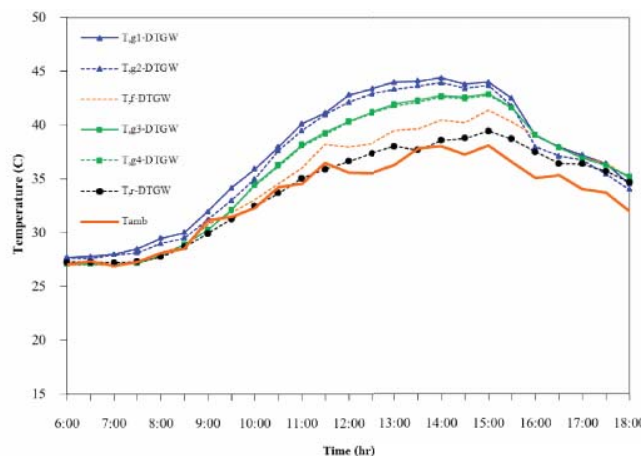

Fig. 5 Hourly variation of measured temperature of and DTGW

2) Simulation Results

Temperature contour across the façade wall at various constant heat fluxes is shown in Fig. 6. The temperature within the air gap space increases with the increase of incoming incident heat flux obviously. The region close to the top has a high temperature than elsewhere within the air gap space.

Figs. 7 and 8 show different positions of temperature across the air gap. It could be observed that the temperature lowers along the propagation direction due to the skin depth heating effect. The temperature of DCGW is much higher when compared to those of DTGW. This due to the contribution of heat associated with the incident heat flux through the clear glass slats. (See Table I)

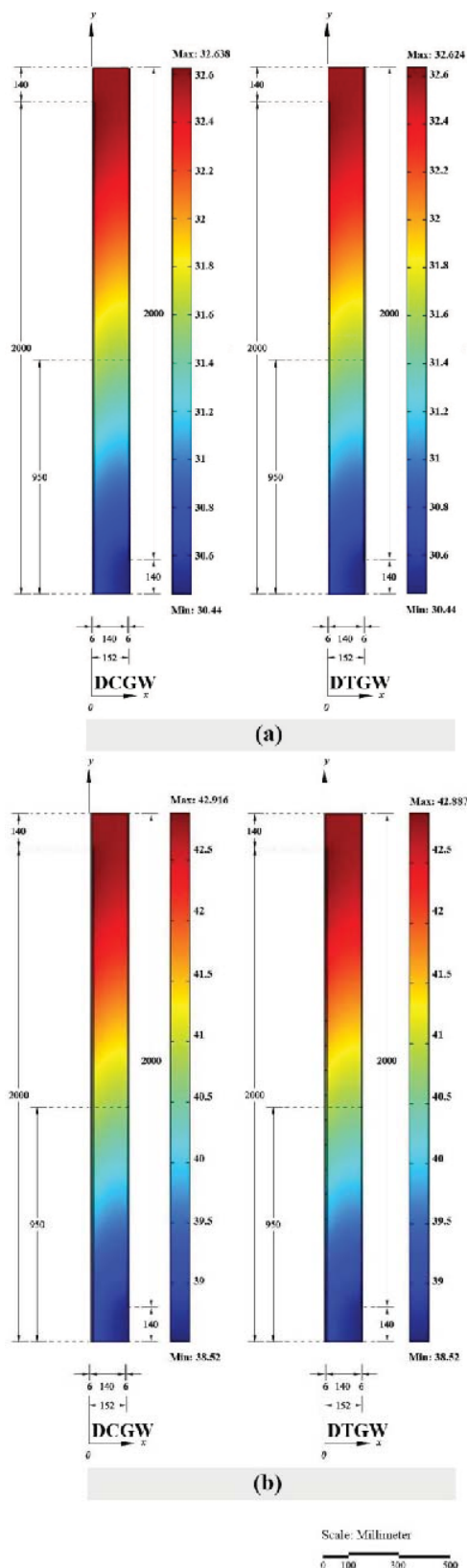

Fig. 6 Simulated result of temperature contour of DCGW and DTGW
 (a) $q''=400 \text{ W} \cdot \text{m}^{-2}$, $T=30.5 \text{ C}$, $u=0.2 \text{ m} \cdot \text{s}^{-1}$ (b) $q''=800 \text{ W} \cdot \text{m}^{-2}$, $T=38.5 \text{ C}$, $u=0.2 \text{ m} \cdot \text{s}^{-1}$

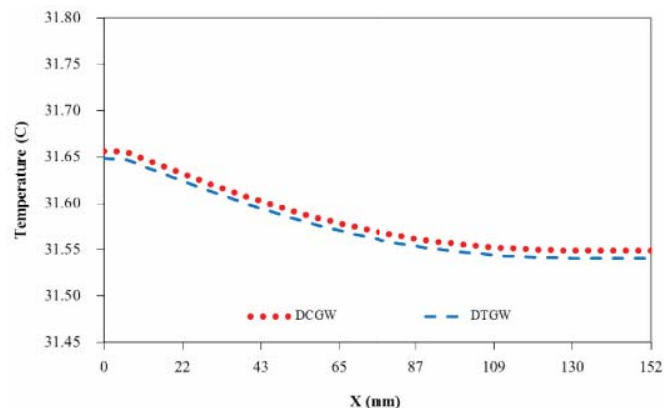

Fig. 7 Simulated result across the air gap temperature of DCGW and DTGW, $q''=400 \text{ W} \cdot \text{m}^{-2}$, $T=30.5 \text{ C}$, $u=0.2 \text{ m} \cdot \text{s}^{-1}$

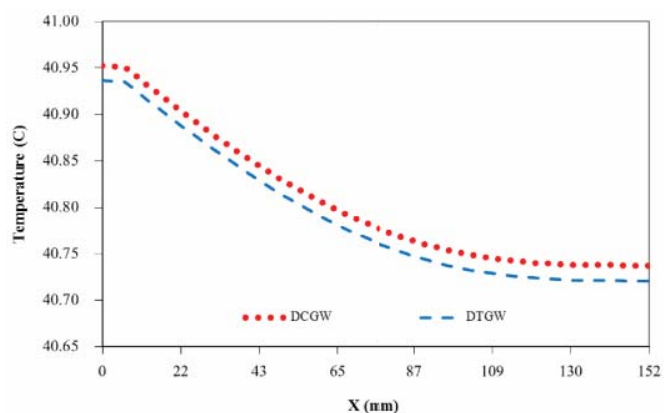

Fig. 8 Simulated result across the air gap temperature of DCGW and DTGW, $q''=800 \text{ W} \cdot \text{m}^{-2}$, $T=38.5 \text{ C}$, $u=0.2 \text{ m} \cdot \text{s}^{-1}$

TABLE I
 PROPERTIES OF CONSTRUCTION MATERIALS

Materials	Thermal Conductivity $\text{W} \cdot \text{m}^{-1} \cdot \text{K}^{-1}$	Thermal Absorptivity $\text{L} \cdot \text{g}^{-1} \cdot \text{cm}^{-1}$	Thermal Emissivity	Specific Heat $\text{kJ} \cdot \text{kg}^{-1} \cdot \text{K}^{-1}$	Density $\text{kg} \cdot \text{m}^{-3}$
Clear glass	0.344	0.13	0.89	1.41	2487

B. Air Velocity through the Air Gap

1) Experimental Results

The DCGW and DTGW are heated by solar radiation and the stored heat in their cavity is utilized to induce ventilation. The gap heated surface of both DCGW and DTGW generates a natural convection current that withdraws air from the room and extracts it to the ambient at the outlet opening. As a consequence outdoor air enters the room through the room openings making the indoor more comfortable. Accordingly, the higher is the solar intensity, the greater is the temperature difference between air gap and room and hence, the larger is the induced airflow rate. Fig. 9 showed a comparison between induced volume airflow rate of DCGW and DTGW. Obviously, the airflow rate induced by the DCGW is much higher than that of DTGW as more heat is admitted into the air gap.

2) Simulation Results

Obviously, the temperature gradient across the height air gap and increased constant heat flux. The temperature of heat flux, the different of materials and to protect significantly increased quasi linearly velocity from the inlet up to the outlet air of the air gap. Air temperature within the air gap space also increased following the constant heat flux but mainly the higher rate of air temperature was observed. Fig. 10 showed the velocity vector within the air gap with for the different cases, considered. The simulation results of velocity across the air gap appear good agreement with velocity vector distribution. Also the simulation models of DCGW showed significant gradient of air gap temperature height than that DTGW. It could be observed the buoyancy force increases as a result from direct lighting transmitted through clear glass slats leading to higher air velocity in the air gap as showed in Figs. 11 and 12.

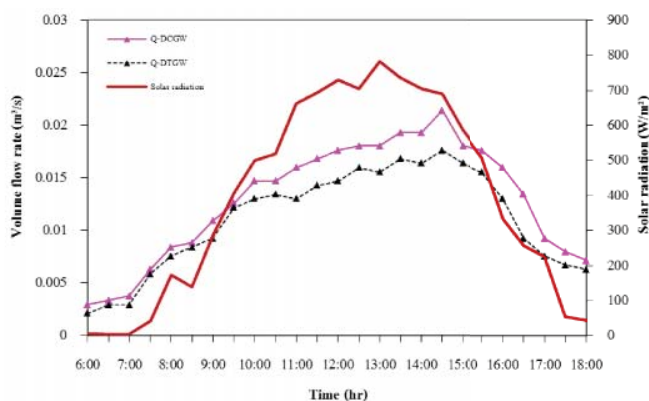

Fig. 9 Hourly variations of volume flow rate and solar radiation of DCGW and DTGW

C. Comparison between Experimental and Simulations Result

Tables II, III showed a comparison of surface temperature of materials across the air gap space between experimental and simulations result. It can be seen that the simulation results are close to the data obtained from the experiments. The difference between the simulated and measured profiles observed varies between 3 to 7%. This is mainly due to the effect of inlet air temperature considered constant during each heat fluxes and velocity in our program.

V. CONCLUSION

An experimental and numerical study of the thermal performance of Double Clear Glass is presented. Experimental results conducted using a configuration of 2.14 m high and 14 cm air gap are in good agreement with those obtained by using the finite element method (FEM) via COMSOL™ Multiphysics. Therefore the computer program can be used for estimating the performance of the system toward an application design of DTGW with different types of the wall. This study confirmed that DTGW is highly suitable for hot countries: it can reduce heat gain through glass walls into the house by developing air circulation, which can help improve

the thermal comfort of residents too. The proposed DTGW was also economical due to low cost of materials used. The use of DTGW can also reduce the usage of fans due to induced ventilation. During daytime when residents are away from their homes, indoor temperature will be much lower which may help reducing demand on electrical energy for air-conditioning as evening indoor conditions will be moderate.

TABLE II
MEASURED AND SIMULATED THE POSITION OF SURFACE TEMPERATURES OF MATERIALS OF THE DCGW AND DTGW: $Q''=400 \text{ W. m}^{-2}$, $T=30.5 \text{ C}$, $U=0.2 \text{ M.S}^{-1}$

DCGW	g1	g2	g3	g4	Tout	Tf	Tin
Experimental	33.57	33.55	33.13	33.32	36.5	32.98	32.5
Simulation	31.66	31.66	31.55	31.55	32.58	31.57	30.5
Absolute deviation	-1.91	-1.89	-1.58	-1.77	-3.92	-1.41	-2.00
Relative deviation	-6%	-6%	-5%	-5%	-11%	-4%	-6%

DTGW	g1	g2	g3	g4	Tout	Tf	Tin
Experimental (16-Feb-2012)	33.5	33.45	31.9	31.85	33.45	31.95	31.07
Simulation	31.65	31.65	31.54	31.54	32.59	31.56	30.5
Absolute deviation	-1.85	-1.80	-0.36	-0.31	-0.86	-0.39	-0.57
Relative deviation	-6%	-5%	-1%	-1%	-3%	-1%	-2%

TABLE III
MEASURED AND SIMULATED THE POSITION OF SURFACE TEMPERATURES OF MATERIALS OF THE DCGW AND DTGW: $Q''=800 \text{ W. m}^{-2}$, $T=38.5 \text{ C}$, $U=0.2 \text{ M.S}^{-1}$

DCGW	g1	g2	g3	g4	Tout	Tf	Tin
Experimental	41.91	42.15	43.67	43.92	41.78	40.29	39.3
Simulation	40.95	40.95	40.74	40.74	42.79	40.78	38.5
Absolute deviation	-0.96	-1.20	-2.93	-3.18	1.01	0.49	-0.80
Relative deviation	-2%	-3%	-7%	-7%	2%	1%	-2%

DTGW	g1	g2	g3	g4	Tout	Tf	Tin
Experimental (16-Feb-2012)	43.5	43.34	41.94	41.79	40.15	39.5	39.26
Simulation	40.94	40.94	40.72	40.72	42.82	40.76	38.5
Absolute deviation	-2.56	-2.40	-1.22	-1.07	2.67	1.26	-0.76
Relative deviation	-6%	-6%	-3%	-3%	7%	3%	-2%

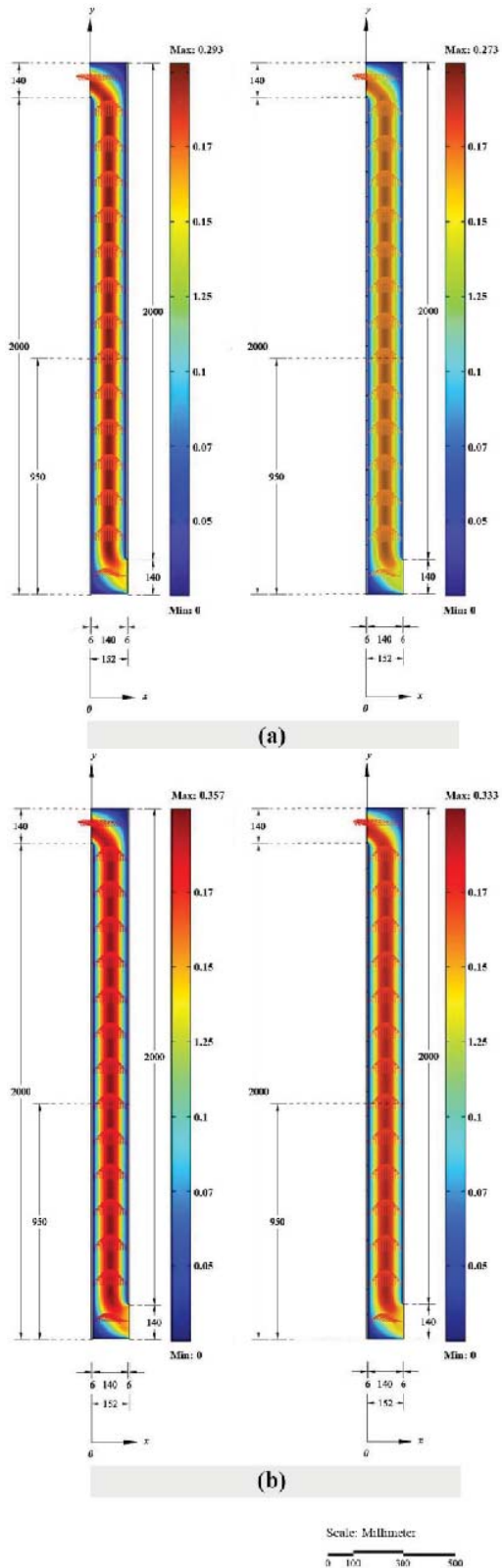

Fig. 10 Simulated result the flow field (arrows) of the velocity in the air gap of DCGW and DTGW (a) $q''=400 \text{ W. m}^{-2}$, $T= 30.5 \text{ C}$, $u= 0.2 \text{ m.s}^{-1}$ (b) $q''=800 \text{ W. m}^{-2}$, $T= 38.5 \text{ C}$, $u= 0.2 \text{ m.s}^{-1}$

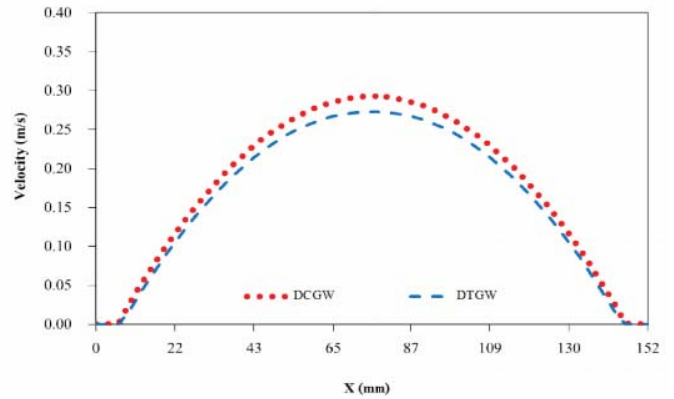

Fig. 11 Simulated result of the velocity in the air gap of DCGW and DTGW $q''=400 \text{ W. m}^{-2}$, $T= 30.5 \text{ C}$, $u= 0.2 \text{ m.s}^{-1}$

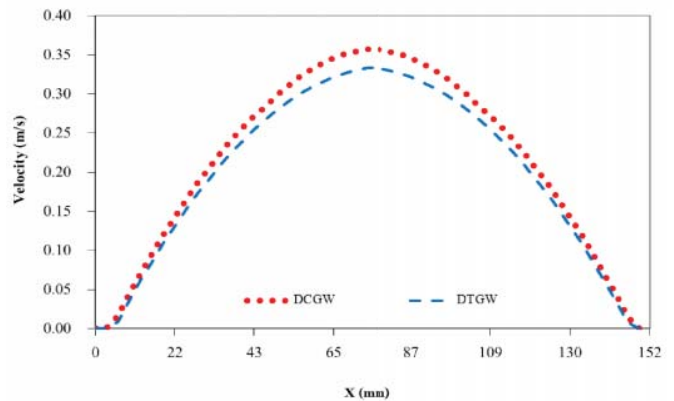

Fig. 12 Simulated result of the velocity in the air gap of DCGW and DTGW $q''=800 \text{ W. m}^{-2}$, $T= 38.5 \text{ C}$, $u= 0.2 \text{ m.s}^{-1}$

ACKNOWLEDGMENT

This Research was supported by the Faculty of Architecture and Design of KMUTNB. (ArchR&C 01/56). The authors are grateful to Center of Excellence in Sustainable Energy and Environment (SEE) of Thaksin University (Phatthalung Campus) for the use of COMSOL™ Multiphysics.

REFERENCES

- [1] J. Khedari, C. Pongsathirat, W. Puangsombut, J. Hirunlabh, "Experimental performance of a partially-glazed Modified Trombe Wall", *The International Journal of Ambient Energy* 2005;26:27-36.
- [2] P. Chantawong, J. Hirunlabh, B. Zeghamati, J. Khedari, S. Teekasap, M. M Win, "Investigation on thermal performance of solar chimney wall", *Solar Energy* 2006;80:288-97.
- [3] W. Puangsombut, "Experimental performance of solar chimney window on school building" *Research and Development Journal of The Engineering Institute of Thailand under H.M. The King's Patronage* 2009;20:70-5.
- [4] T. Ananacha, "Reduction of Heat Accumulated in attic by PV Ventilation for Energy Consumption Reduction of Air Conditioner for housing", *The 19th Sarasat: Architectural Journal the Faculty of Architecture*, May 2, 2014, Chulalongkorn University.
- [5] T. Ananacha, W. Puangsombut, J. Hirunlabh, "Shading Effects on the winter of the Thai Modern Façade Wall", *Proceedings of 3th International Conference on Sustainable Energy and Green Architect (SEGA)*, Bangkok, Thailand; 2012.
- [6] T. Ananacha, W. Puangsombut, J. Hirunlabh and J. Khedari, "Field Investigation of the Thermal Performance of the Thai Modern Façade

- Wall", *The International Journal of Ventilation*, Vol. 12, No 3, December 2013, pp. 223-234.
- [7] T. Ananacha, W. Puangsombut, J. Hirunlabh and J. Khedari, "Daylighting and Thermal Performance of Thai Modern Façade Wall", *Energy Procedia*, Vol. 52 (2014), pp. 271-277.
- [8] T. Ananacha, "Daylighting and Thermal Performance of Double Glass Wall" International Conference on Advances in Science & Technology (ICAST), Chonburi, Thailand; 2014.
- [9] W. Maneesarn, *Global Solar Radiation and the climate statistics 30 year period of Thai Meteorological Data*: No 551.582-02-2538, ISBN:974-7567-25-3; September 1995